

RED-D-ARC

GX 271 Chopper

For use with machines having Code Numbers: **10527**

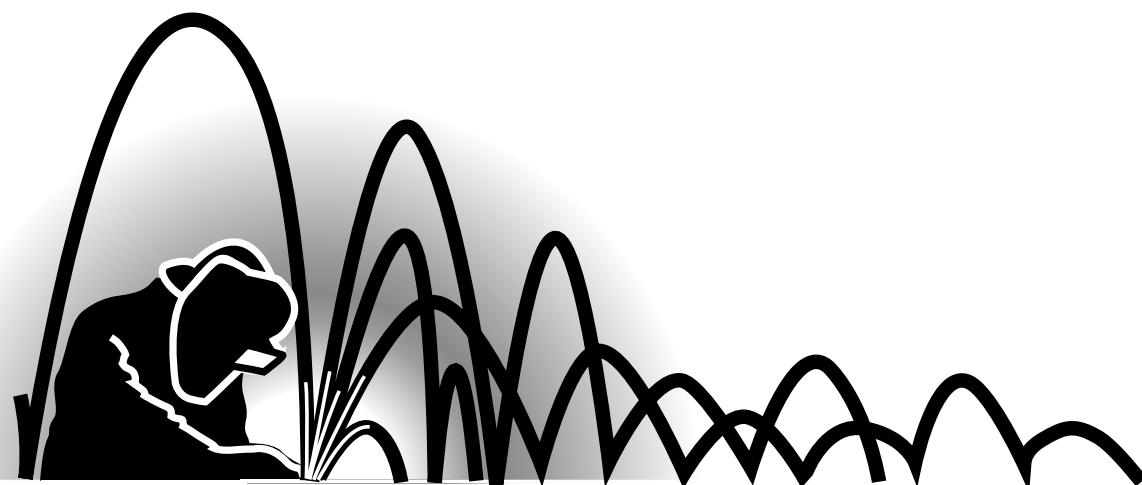

RED-D-ARC

Welderrentals

OPERATOR'S MANUAL

Red-D-Arc Spec-Built Welding Equipment

This **RED-D-ARC** welder is built to **RED-D-ARC Extreme Duty** design specifications by Lincoln Electric.

Safety Depends on You

This welder is designed and built with safety in mind.

However, your overall safety can be increased by proper installation ... and thoughtful operation on your part.

DO NOT INSTALL, OPERATE OR REPAIR THIS EQUIPMENT WITHOUT READING THIS MANUAL AND THE SAFETY PRECAUTIONS CONTAINED THROUGHOUT.

And, most importantly, think before you act and be careful.

1-800-245-3660

North America's Largest Fleet of Welding Equipment

⚠ WARNING

⚠ CALIFORNIA PROPOSITION 65 WARNINGS ⚠

Diesel engine exhaust and some of its constituents are known to the State of California to cause cancer, birth defects, and other reproductive harm.

The Above For Diesel Engines

The engine exhaust from this product contains chemicals known to the State of California to cause cancer, birth defects, or other reproductive harm.

The Above For Gasoline Engines

ARC WELDING CAN BE HAZARDOUS. PROTECT YOURSELF AND OTHERS FROM POSSIBLE SERIOUS INJURY OR DEATH. KEEP CHILDREN AWAY. PACEMAKER WEARERS SHOULD CONSULT WITH THEIR DOCTOR BEFORE OPERATING.

Read and understand the following safety highlights. For additional safety information, it is strongly recommended that you purchase a copy of "Safety in Welding & Cutting - ANSI Standard Z49.1" from the American Welding Society, P.O. Box 351040, Miami, Florida 33135 or CSA Standard W117.2-1974. A Free copy of "Arc Welding Safety" booklet E205 is available from the Lincoln Electric Company, 22801 St. Clair Avenue, Cleveland, Ohio 44117-1199.

BE SURE THAT ALL INSTALLATION, OPERATION, MAINTENANCE AND REPAIR PROCEDURES ARE PERFORMED ONLY BY QUALIFIED INDIVIDUALS.



FOR ENGINE powered equipment.

1.a. Turn the engine off before troubleshooting and maintenance work unless the maintenance work requires it to be running.



1.b. Operate engines in open, well-ventilated areas or vent the engine exhaust fumes outdoors.



1.c. Do not add the fuel near an open flame welding arc or when the engine is running. Stop the engine and allow it to cool before refueling to prevent spilled fuel from vaporizing on contact with hot engine parts and igniting. Do not spill fuel when filling tank. If fuel is spilled, wipe it up and do not start engine until fumes have been eliminated.

1.d. Keep all equipment safety guards, covers and devices in position and in good repair. Keep hands, hair, clothing and tools away from V-belts, gears, fans and all other moving parts when starting, operating or repairing equipment.

1.e. In some cases it may be necessary to remove safety guards to perform required maintenance. Remove guards only when necessary and replace them when the maintenance requiring their removal is complete. Always use the greatest care when working near moving parts.



1.f. Do not put your hands near the engine fan. Do not attempt to override the governor or idler by pushing on the throttle control rods while the engine is running.

1.g. To prevent accidentally starting gasoline engines while turning the engine or welding generator during maintenance work, disconnect the spark plug wires, distributor cap or magneto wire as appropriate.



1.h. To avoid scalding, do not remove the radiator pressure cap when the engine is hot.



ELECTRIC AND MAGNETIC FIELDS may be dangerous

2.a. Electric current flowing through any conductor causes localized Electric and Magnetic Fields (EMF). Welding current creates EMF fields around welding cables and welding machines

2.b. EMF fields may interfere with some pacemakers, and welders having a pacemaker should consult their physician before welding.

2.c. Exposure to EMF fields in welding may have other health effects which are now not known.

2.d. All welders should use the following procedures in order to minimize exposure to EMF fields from the welding circuit:

2.d.1. Route the electrode and work cables together - Secure them with tape when possible.

2.d.2. Never coil the electrode lead around your body.

2.d.3. Do not place your body between the electrode and work cables. If the electrode cable is on your right side, the work cable should also be on your right side.

2.d.4. Connect the work cable to the workpiece as close as possible to the area being welded.

2.d.5. Do not work next to welding power source.

Mar '95



RED-D-ARC GX 271 Chopper



ELECTRIC SHOCK can kill.

- 3.a. The electrode and work (or ground) circuits are electrically "hot" when the welder is on. Do not touch these "hot" parts with your bare skin or wet clothing. Wear dry, hole-free gloves to insulate hands.
- 3.b. Insulate yourself from work and ground using dry insulation. Make certain the insulation is large enough to cover your full area of physical contact with work and ground.
- In addition to the normal safety precautions, if welding must be performed under electrically hazardous conditions (in damp locations or while wearing wet clothing; on metal structures such as floors, gratings or scaffolds; when in cramped positions such as sitting, kneeling or lying, if there is a high risk of unavoidable or accidental contact with the workpiece or ground) use the following equipment:**
- Semiautomatic DC Constant Voltage (Wire) Welder.
 - DC Manual (Stick) Welder.
 - AC Welder with Reduced Voltage Control.
- 3.c. In semiautomatic or automatic wire welding, the electrode, electrode reel, welding head, nozzle or semiautomatic welding gun are also electrically "hot".
- 3.d. Always be sure the work cable makes a good electrical connection with the metal being welded. The connection should be as close as possible to the area being welded.
- 3.e. Ground the work or metal to be welded to a good electrical (earth) ground.
- 3.f. Maintain the electrode holder, work clamp, welding cable and welding machine in good, safe operating condition. Replace damaged insulation.
- 3.g. Never dip the electrode in water for cooling.
- 3.h. Never simultaneously touch electrically "hot" parts of electrode holders connected to two welders because voltage between the two can be the total of the open circuit voltage of both welders.
- 3.i. When working above floor level, use a safety belt to protect yourself from a fall should you get a shock.
- 3.j. Also see Items 6.c. and 8.



ARC RAYS can burn.

- 4.a. Use a shield with the proper filter and cover plates to protect your eyes from sparks and the rays of the arc when welding or observing open arc welding. Headshield and filter lens should conform to ANSI Z87.1 standards.
- 4.b. Use suitable clothing made from durable flame-resistant material to protect your skin and that of your helpers from the arc rays.
- 4.c. Protect other nearby personnel with suitable, non-flammable screening and/or warn them not to watch the arc nor expose themselves to the arc rays or to hot spatter or metal.



FUMES AND GASES can be dangerous.

- 5.a. Welding may produce fumes and gases hazardous to health. Avoid breathing these fumes and gases. When welding, keep your head out of the fume. Use enough ventilation and/or exhaust at the arc to keep fumes and gases away from the breathing zone. **When welding with electrodes which require special ventilation such as stainless or hard facing (see instructions on container or MSDS) or on lead or cadmium plated steel and other metals or coatings which produce highly toxic fumes, keep exposure as low as possible and below Threshold Limit Values (TLV) using local exhaust or mechanical ventilation. In confined spaces or in some circumstances, outdoors, a respirator may be required. Additional precautions are also required when welding on galvanized steel.**
- 5.b. Do not weld in locations near chlorinated hydrocarbon vapors coming from degreasing, cleaning or spraying operations. The heat and rays of the arc can react with solvent vapors to form phosgene, a highly toxic gas, and other irritating products.
- 5.c. Shielding gases used for arc welding can displace air and cause injury or death. Always use enough ventilation, especially in confined areas, to insure breathing air is safe.
- 5.d. Read and understand the manufacturer's instructions for this equipment and the consumables to be used, including the material safety data sheet (MSDS) and follow your employer's safety practices. MSDS forms are available from your welding distributor or from the manufacturer.
- 5.e. Also see item 1.b.

Mar '95

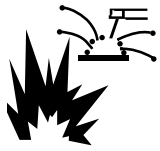

WELDING SPARKS can cause fire or explosion.

6.a. Remove fire hazards from the welding area. If this is not possible, cover them to prevent the welding sparks from starting a fire.

Remember that welding sparks and hot materials from welding can easily go through small cracks and openings to adjacent areas. Avoid welding near hydraulic lines. Have a fire extinguisher readily available.

- 6.b. Where compressed gases are to be used at the job site, special precautions should be used to prevent hazardous situations. Refer to "Safety in Welding and Cutting" (ANSI Standard Z49.1) and the operating information for the equipment being used.
- 6.c. When not welding, make certain no part of the electrode circuit is touching the work or ground. Accidental contact can cause overheating and create a fire hazard.
- 6.d. Do not heat, cut or weld tanks, drums or containers until the proper steps have been taken to insure that such procedures will not cause flammable or toxic vapors from substances inside. They can cause an explosion even though they have been "cleaned". For information, purchase "Recommended Safe Practices for the Preparation for Welding and Cutting of Containers and Piping That Have Held Hazardous Substances", AWS F4.1 from the American Welding Society (see address above).
- 6.e. Vent hollow castings or containers before heating, cutting or welding. They may explode.
- 6.f. Sparks and spatter are thrown from the welding arc. Wear oil free protective garments such as leather gloves, heavy shirt, cuffless trousers, high shoes and a cap over your hair. Wear ear plugs when welding out of position or in confined places. Always wear safety glasses with side shields when in a welding area.
- 6.g. Connect the work cable to the work as close to the welding area as practical. Work cables connected to the building framework or other locations away from the welding area increase the possibility of the welding current passing through lifting chains, crane cables or other alternate circuits. This can create fire hazards or overheat lifting chains or cables until they fail.
- 6.h. Also see item 1.c.



CYLINDER may explode if damaged.

7.a. Use only compressed gas cylinders containing the correct shielding gas for the process used and properly operating regulators designed for the gas and pressure used. All hoses, fittings, etc. should be suitable for the application and maintained in good condition.

- 7.b. Always keep cylinders in an upright position securely chained to an undercarriage or fixed support.
- 7.c. Cylinders should be located:
 - Away from areas where they may be struck or subjected to physical damage.
 - A safe distance from arc welding or cutting operations and any other source of heat, sparks, or flame.
- 7.d. Never allow the electrode, electrode holder or any other electrically "hot" parts to touch a cylinder.
- 7.e. Keep your head and face away from the cylinder valve outlet when opening the cylinder valve.
- 7.f. Valve protection caps should always be in place and hand tight except when the cylinder is in use or connected for use.
- 7.g. Read and follow the instructions on compressed gas cylinders, associated equipment, and CGA publication P-1, "Precautions for Safe Handling of Compressed Gases in Cylinders," available from the Compressed Gas Association 1235 Jefferson Davis Highway, Arlington, VA 22202.



FOR ELECTRICALLY powered equipment.

- 8.a. Turn off input power using the disconnect switch at the fuse box before working on the equipment.
- 8.b. Install equipment in accordance with the U.S. National Electrical Code, all local codes and the manufacturer's recommendations.
- 8.c. Ground the equipment in accordance with the U.S. National Electrical Code and the manufacturer's recommendations.

Mar '95

PRÉCAUTIONS DE SÛRETÉ

Pour votre propre protection lire et observer toutes les instructions et les précautions de sûreté spécifiques qui paraissent dans ce manuel aussi bien que les précautions de sûreté générales suivantes:

Sûreté Pour Soudage A L'Arc

1. Protégez-vous contre la secousse électrique:
 - a. Les circuits à l'électrode et à la pièce sont sous tension quand la machine à souder est en marche. Eviter toujours tout contact entre les parties sous tension et la peau nue ou les vêtements mouillés. Porter des gants secs et sans trous pour isoler les mains.
 - b. Faire très attention de bien s'isoler de la masse quand on soude dans des endroits humides, ou sur un plancher métallique ou des grilles métalliques, principalement dans les positions assis ou couché pour lesquelles une grande partie du corps peut être en contact avec la masse.
 - c. Maintenir le porte-électrode, la pince de masse, le câble de soudage et la machine à souder en bon et sûr état de fonctionnement.
 - d. Ne jamais plonger le porte-électrode dans l'eau pour le refroidir.
 - e. Ne jamais toucher simultanément les parties sous tension des porte-électrodes connectés à deux machines à souder parce que la tension entre les deux pinces peut être le total de la tension à vide des deux machines.
 - f. Si on utilise la machine à souder comme une source de courant pour soudage semi-automatique, ces précautions pour le porte-électrode s'appliquent aussi au pistolet de soudage.
2. Dans le cas de travail au dessus du niveau du sol, se protéger contre les chutes dans le cas où on reçoit un choc. Ne jamais enrouler le câble-électrode autour de n'importe quelle partie du corps.
3. Un coup d'arc peut être plus sévère qu'un coup de soleil, donc:
 - a. Utiliser un bon masque avec un verre filtrant approprié ainsi qu'un verre blanc afin de se protéger les yeux du rayonnement de l'arc et des projections quand on soude ou quand on regarde l'arc.
 - b. Porter des vêtements convenables afin de protéger la peau de soudeur et des aides contre le rayonnement de l'arc.
 - c. Protéger l'autre personnel travaillant à proximité au soudage à l'aide d'écrans appropriés et non-inflammables.
4. Des gouttes de laitier en fusion sont émises de l'arc de soudage. Se protéger avec des vêtements de protection libres de l'huile, tels que les gants en cuir, chemise épaisse, pantalons sans revers, et chaussures montantes.
5. Toujours porter des lunettes de sécurité dans la zone de soudage. Utiliser des lunettes avec écrans latéraux dans les

zones où l'on pique le laitier.

6. Eloigner les matériaux inflammables ou les recouvrir afin de prévenir tout risque d'incendie dû aux étincelles.
7. Quand on ne soude pas, poser la pince à un endroit isolé de la masse. Un court-circuit accidentel peut provoquer un échauffement et un risque d'incendie.
8. S'assurer que la masse est connectée le plus près possible de la zone de travail qu'il est pratique de le faire. Si on place la masse sur la charpente de la construction ou d'autres endroits éloignés de la zone de travail, on augmente le risque de voir passer le courant de soudage par les chaînes de levage, câbles de grue, ou autres circuits. Cela peut provoquer des risques d'incendie ou d'échauffement des chaînes et des câbles jusqu'à ce qu'ils se rompent.
9. Assurer une ventilation suffisante dans la zone de soudage. Ceci est particulièrement important pour le soudage de tôles galvanisées plombées, ou cadmiées ou tout autre métal qui produit des fumées toxiques.
10. Ne pas souder en présence de vapeurs de chlore provenant d'opérations de dégraissage, nettoyage ou pistolage. La chaleur ou les rayons de l'arc peuvent réagir avec les vapeurs du solvant pour produire du phosgène (gas fortement toxique) ou autres produits irritants.
11. Pour obtenir de plus amples renseignements sur la sûreté, voir le code "Code for safety in welding and cutting" CSA Standard W 117.2-1974.

PRÉCAUTIONS DE SÛRETÉ POUR LES MACHINES À SOUDER À TRANSFORMATEUR ET À REDRESSEUR

1. Relier à la terre le châssis du poste conformément au code de l'électricité et aux recommandations du fabricant. Le dispositif de montage ou la pièce à souder doit être branché à une bonne mise à la terre.
2. Autant que possible, l'installation et l'entretien du poste seront effectués par un électricien qualifié.
3. Avant de faire des travaux à l'intérieur de poste, la débrancher à l'interrupteur à la boîte de fusibles.
4. Garder tous les couvercles et dispositifs de sûreté à leur place.

Mar. '93

Thank You — for selecting this **QUALITY** product. We want you to take pride in operating this product ••• as much pride as we have in bringing this product to you!

Please Examine Carton and Equipment For Damage Immediately

When this equipment is shipped, title passes to the purchaser upon receipt by the carrier. Consequently, Claims for material damaged in shipment must be made by the purchaser against the transportation company at the time the shipment is received.

Please record your equipment identification information below for future reference. This information can be found on your machine nameplate.

Model Name & Number _____

Code & Serial Number _____

Date of Purchase _____

Whenever you request replacement parts for or information on this equipment always supply the information you have recorded above.

Read this Operators Manual completely before attempting to use this equipment. Save this manual and keep it handy for quick reference. Pay particular attention to the safety instructions we have provided for your protection. The level of seriousness to be applied to each is explained below:

⚠ WARNING

This statement appears where the information **must** be followed **exactly** to avoid **serious personal injury** or **loss of life**.

⚠ CAUTION

This statement appears where the information **must** be followed to avoid **minor personal injury** or **damage to this equipment**.

Installation.....	Section A
Technical Specifications	A-1
Installation Instructions.....	A-3
Location and Ventilation	A-3
Storing	A-3
Stacking	A-3
Angle of Operation	A-3
High Altitude Operation	A-4
Lifting.....	A-4
Additional Safety Precautions	A-4
Pre-Operation Engine Service.....	A-4
Oil.....	A-4
Fuel	A-5
Battery Connections.....	A-5
Muffler	A-5
Spark Arrester	A-5
Electrical Connections	A-6
Machine Grounding.....	A-6
Welding Cable Connections.....	A-6
Auxiliary Power Receptacles, Plugs, and Hand-Held Equipment	A-7
Circuit Breakers	A-7
Premises Wiring	A-7

Operation.....	Section B
General Description.....	B-1
Design Features	B-1
Other Features	B-2
Recommended Applications.....	B-2
Limitations	B-2
Additional Safety Precautions	B-2
Controls and Settings	B-3
Welder / Generator Controls	B-3
Engine Operation	B-4
Before Starting the Engine	B-4
Starting the Engine.....	B-4
Stopping the Engine.....	B-5
Fuel Consumption Data	B-5
Welding Operation.....	B-6
Welder Controls - Function and Operation.....	B-6
Stick Welding	B-7
Pipe Welding	B-7
TIG Welding	B-7
Wire Welding.....	B-8
Summary of Welding Processes and Machine Settings	B-9
Auxiliary Power.....	B-10
Simultaneous Welding and Power Loads	B-10

Accessories	Section C
General Options / Accessories	C-1
TIG Welding Options / Accessories.....	C-1
Semiautomatic FCAW and MIG Welding Options / Accessories.....	C-2
Connection Diagrams for Accessories	C-3

Maintenance	Section D
Safety Precautions	D-1
Routine and Periodic Engine Maintenance	D-1
Engine Maintenance Parts	D-1
Engine Maintenance Schedule	D-2
Changing the Engine Oil	D-3
Changing the Engine Oil Filter	D-3
Air Cleaner Service	D-3
Spark Plug Service	D-4
Fuel Filter Service	D-5
Engine Adjustments	D-5
Battery Maintenance	D-5
Servicing Optional Spark Arrestor	D-6
Welder / Generator Maintenance	D-6
Storage	D-6
Cleaning	D-6
Brush Removal and Replacement	D-6
<hr/>	
Troubleshooting	Section E
Safety Precautions.....	E-1
How to Use Troubleshooting Guide.....	E-1
Troubleshooting Guide	E-2
<hr/>	
Wiring Diagram & Dimension Print	Section F
<hr/>	
Parts Lists	P325 Series
<hr/>	

TECHNICAL SPECIFICATIONS - Red-D-Arc GX-271 (K1623-1)

INPUT - ENGINE					
Make/Model	Description	Speed (RPM)	Displacement	Starting System	Capacities
Honda GX620 Gas Engine	2 cylinder 20.0 HP @ 3600 RPM Full Load	High Idle 3700 Low Idle 2400 Full Load 3400	37.7 cu. in (615 cc)	12VDC battery (Group 58, 435 cold crank amps) 20A. Battery Charger	Fuel: 9.0 gal. 34 L Oil: 1.59 Qts. 1.5 L
			Bore x Stroke 3.00" x 2.60" (77 mm x 66 mm)		
RATED OUTPUT - WELDER					
Welding Output		Volts at Rated Amps		Duty Cycle ¹	Max. OCV @ 3700 RPM
CC Stick/TIG, Pipe and CV Wire Welding 275 Amps 300 Amps		28 volts 25 volts		100% 60%	80 volts DC
OUTPUT - GENERATOR					
Auxiliary Power ²					
8,000 Watts, 60 Hz 120/240 Volts 100 % Duty Cycle 42 Volt Auxiliary Power for Wire Feeders					
PHYSICAL DIMENSIONS					
HEIGHT	WIDTH		DEPTH		WEIGHT
30.3 in.	19.1 in.		42.0 in.		469 lbs.
770 mm	485 mm		1067 mm		212 kg.

1. Duty cycle is based on a 10 minute period. This machine can be loaded to 300 amps for 6 minutes out of every 10 minute period.

2. Output rating in watts is equivalent to volt-amperes at unity power factor. Output voltage is within $\pm 10\%$ at all loads up to rated capacity. When welding, available auxiliary power will be reduced.

TECHNICAL SPECIFICATIONS - Red-D-Arc GX-271 (K1623-1)

Stick/TIG (CC) Mode Min. and Max. Arc Force

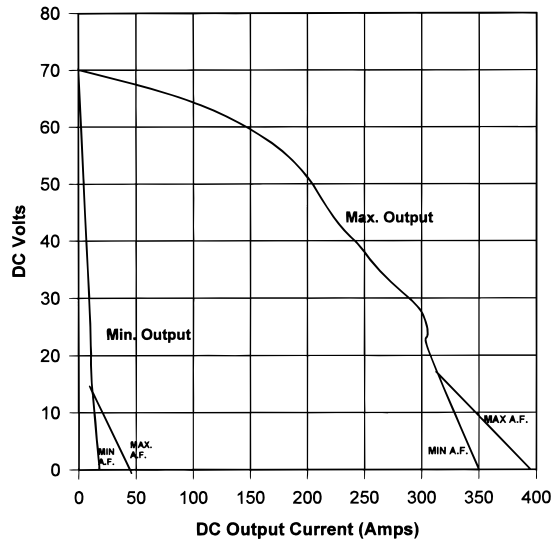

PIPE Mode

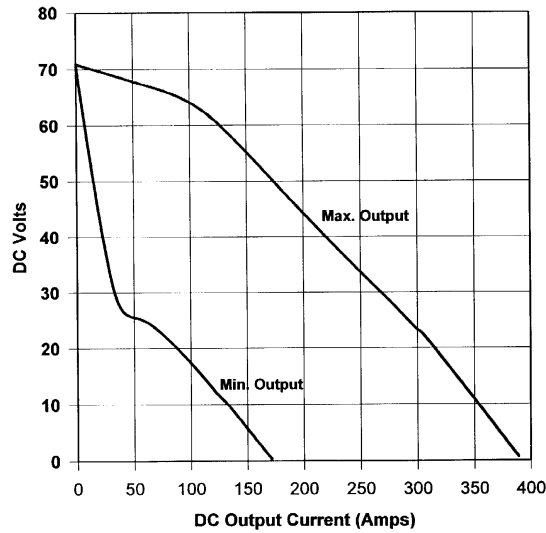

WIRE FEED (CV) Mode

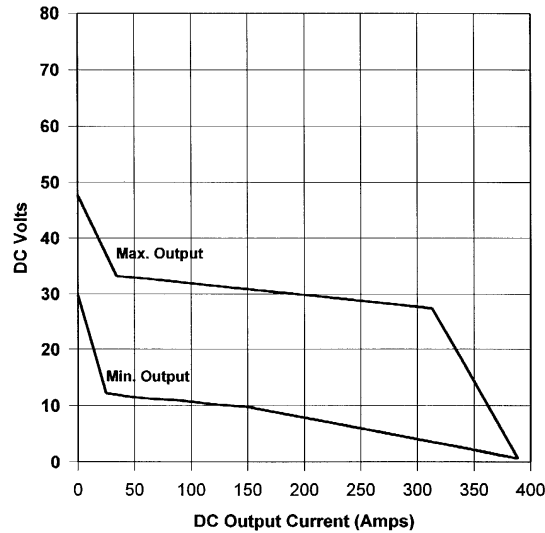

INSTALLATION INSTRUCTIONS

SAFETY PRECAUTIONS

WARNING

Do not attempt to use this equipment until you have thoroughly read the engine manufacturer's manual supplied with your welder. It includes important safety precautions, detailed engine starting, operating and maintenance instructions, and parts lists.



ELECTRIC SHOCK can kill.

- Do not touch electrically live parts or electrode with skin or wet clothing.
- Insulate yourself from work and ground
- Always wear dry insulating gloves.



ENGINE EXHAUST can kill.

- Use in open, well ventilated areas or vent exhaust outside.



MOVING PARTS can injure.

- Do not operate with doors open or guards off.
- Stop engine before servicing.
- Keep away from moving parts.

See additional warning information at front of this operator's manual.

Only qualified personnel should install, use, or service this equipment.

LOCATION AND VENTILATION

Whenever you use the GX-271, be sure that clean cooling air can flow through the machine's engine and the machine case. Avoid dusty, dirty areas. Also, keep the machine away from heat sources. Do not place the engine end of the machine anywhere near hot engine exhaust from another machine or closer than two feet from a wall. And of course, make sure that engine exhaust is ventilated to an open, outside area.

The GX-271 may be used outdoors. Do not set the machine in puddles or otherwise submerge it in water. Such practices pose safety hazards and cause improper operation and corrosion of parts.

Always operate the GX-271 with the case roof on and all machine components completely assembled. This will protect you from the dangers of moving parts, hot metal surfaces, and live electrical devices.

STORING

1. Store the machine in a cool, dry place when it is not in use. Protect it from dust and dirt. Keep it where it can't be accidentally damaged from construction activities, moving vehicles, and other hazards.
2. Drain the engine oil and refill with fresh oil. Run the engine for about five minutes to circulate oil to all the parts. See the MAINTENANCE section of this manual for details on changing oil.
3. Remove the battery, recharge it, and adjust the electrolyte level. Store the battery in a dry, dark place.

STACKING

GX-271 machines **CANNOT** be stacked.

ANGLE OF OPERATION

Place the machine on a secure, level surface whenever you use it or store it. Any surfaces you place it on other than the ground must be firm, non-skid, and structurally sound.

The engine is designed to run in a level position for best performance. It can operate at an angle, but this should never be more than 15 degrees in any direction. If you do operate it at a slight angle, be sure to check the oil regularly and keep the oil level at the FULL mark as it would be in its normal level condition. Also, fuel capacity will be a little less at an angle.

HIGH ALTITUDE OPERATION

At high altitude, the standard carburetor air-fuel mixture will be too rich. Performance will decrease, and fuel consumption will increase. A very rich mixture will also foul the spark plug and cause hard starting.

High altitude performance can be improved by specific modifications to the carburetor. If you always operate your engine at altitudes above (6,000 feet) 1,800 meters, have a engine dealer perform this carburetor modification.

Even with carburetor modification, engine horsepower will decrease about 3.5% for each 1,000 feet (300 meter) increase in altitude. The effect of altitude on horsepower will be greater than this if no carburetor modification is made. Do not operate a modified engine below 6,000 feet.

LIFTING

The GX-271 weighs approximately 469 lbs/212 kg. A lift bail is mounted to the machine frame and should always be used when lifting the machine.

ADDITIONAL SAFETY PRECAUTIONS

WARNING



FALLING EQUIPMENT can cause injury.

- Do not lift this machine using lift bale if it is equipped with a heavy accessory such as trailer or gas cylinder.
- Lift only with equipment of adequate lifting capacity.
- Be sure machine is stable when lifting.

PRE-OPERATION ENGINE SERVICE

CAUTION

READ and UNDERSTAND the engine operating and maintenance instructions supplied with this machine.

WARNING

- Keep hands way from the engine muffler or HOT engine parts.
- Stop the engine when fueling.
- Do not smoke when fueling.
- Do not overfill the fuel tank.
- Wipe up spilled fuel and allow the fumes to clear before starting the engine.
- Keep sparks and flame away from the fuel tank.

OIL

The GX-271 is shipped with the engine filled with SAE 10W-30 oil. CHECK THE OIL LEVEL BEFORE YOU START THE ENGINE. If it is not full, add enough oil to fill it to the full mark.

For more information on oil viscosity and service conditions, see the MAINTENANCE section of this manual and the engine Operator's Manual.

FUEL

Fill the fuel tank with clean, fresh regular grade lead-free gasoline. Observe the fuel gauge while filling to prevent overfilling.

The GX-271 has a 9 U.S. gallon (7.5 Imp. Gal., 34L) fuel tank mounted below the generator. See the Engine Owners Manual for more details about the fuel.

BATTERY CONNECTIONS
WARNING

GASES FROM BATTERY can explode.

- Keep sparks, flame and cigarettes away from battery.

To prevent **EXPLOSION** when:

- **INSTALLING A NEW BATTERY** — disconnect negative cable from old battery first and connect to new battery last.
- **CONNECTING A BATTERY CHARGER** — remove battery from welder by disconnecting negative cable first, then positive cable and battery clamp. When reinstalling, connect negative cable last. Keep well ventilated.
- **USING A BOOSTER** — connect positive lead to battery first then connect negative lead to negative battery lead at engine foot.



BATTERY ACID can burn eyes and skin.

- Wear gloves and eye protection and be careful when working near battery.
- Follow instructions printed on battery.

IMPORTANT: To prevent **ELECTRICAL DAMAGE** WHEN:

- Installing new batteries.
- Using a booster.

Use correct polarity — **Negative Ground**.

The GX-271 is shipped with the negative battery cable disconnected. Before you operate the machine, make sure the Engine Switch is in the STOP position and attach the disconnected cable securely to the negative (-) battery terminal.

Remove the insulating cap from the negative battery terminal. Replace and tighten negative battery cable terminal. **NOTE:** This machine is furnished with a wet charged battery; if unused for several months, the battery may require a booster charge. Be sure to use the correct polarity when charging the battery.

MUFFLER
CAUTION

Shut off the machine and allow the muffler to cool before touching the muffler.

The GX-271 is shipped with a rain cap that is easily attached to the top exhaust.

SPARK ARRESTER

Gasoline engine mufflers may emit sparks when the engine is running. Some federal, state, or local laws require spark arresters in locations where unarrested sparks could present a fire hazard.

Standard mufflers do not act as spark arresters. When local laws require it, a spark arrester must be installed on the machine and properly maintained. An optional spark arrester kit is available for your GX-271. See the ACCESSORIES section of this manual for more information.

CAUTION

An incorrect spark arrester may lead to damage to the engine or reduce performance.

ELECTRICAL CONNECTIONS

See Figure B.1 in the OPERATION section of this manual for location of the 120 and 240 volt receptacles, weld output terminals, circuit breakers and ground stud.

MACHINE GROUNDING



Because the GX-271 creates its own power from its engine driven generator, and if the machine is not connected to premises wiring (home, shop, etc.), you do not need to connect the machine frame to an earth ground. However, for best protection against electrical shock, connect a heavy gauge wire (#8 AWG or larger) from the ground stud located on the bottom of the output panel (See Figure B.1) to a suitable earth ground such as a metal pipe driven into the ground.

WARNING

Do not ground the machine to a pipe that carries explosive or combustible material.

When the GX-271 is mounted on a truck or a trailer, the machine generator ground stud **MUST** be securely connected to the metal frame of the vehicle. See Figure B.1. The ground stud is marked with the ground symbol.

If the GX-271 is connected to premises wiring such as a home or shop, it must be properly connected to the system earth ground.

WELDING CABLE CONNECTIONS

CABLE SIZE AND LENGTH

Be sure to use welding cables that are large enough. The correct size and length becomes especially important when you are welding at a distance from the welder.

Table A.1 lists recommended cable sizes and lengths for rated current and duty cycle. Length refers to the distance from the welder to the work and back to the welder. Cable diameters are increased for long cable lengths to reduce voltage drops.

Lincoln Electric offers a welding accessory kit with the properly specified welding cables. See the ACCESSORIES section of this manual for more information.

TOTAL COMBINED LENGTH OF ELECTRODE AND WORK CABLES

Cable Length	Cable Size for 300 Amps 100% Duty Cycle
0-50 Ft. (0-15 meters)	1/0 AWG
50-100 Ft. (15-39 meters)	1/0 AWG
100-150 Ft. (30-46 meters)	2/0 AWG
150-200 Ft. (46-61 meters)	2/0 AWG
200-250 Ft. (61-76 meters)	3/0 AWG

Table A.1

CABLE INSTALLATION

Install the welding cables to your GX-271 as follows. See Figure B.1 for location of parts.

1. The engine must be OFF to install welding cables.
2. Remove the flanged nuts from the output terminals.
3. Connect the electrode holder and work cables to the weld "+" and "-" output terminals. The terminals are identified on the case front. The polarity requirement for the welding process being used determines which terminal the electrode cable is attached to.
4. Tighten the flanged nuts securely.
5. Be certain that the metal piece you are welding (the "work") is properly connected to the work clamp and cable.
6. Check and tighten the connections periodically.

CAUTION

- Loose connections will cause the output terminals to overheat. The terminals may eventually melt.
- Do not cross the welding cables at the output terminal connection. Keep the cables isolated and separate from one another.

AUXILIARY POWER RECEPTACLES, PLUGS, AND HAND-HELD EQUIPMENT

The control panel of the GX-271 features three auxiliary power receptacles: See Figure B.1.

- Two 15 amp, 120 volt duplex (double outlet) receptacles.
- One 50 amp 120/240 volt single outlet receptacle.

Through these receptacles the machine can supply up to 8,000 rated continuous watts of single-phase, 60 Hz AC power.

For further protection against electric shock, any electrical equipment connected to the 120V duplex receptacles must use a three-blade, grounded type plug or an Underwriter's Laboratories (UL) approved double insulation system with a two-blade plug. Lincoln offers an accessory plug kit that has the right type of plugs. See the ACCESSORIES section of this manual for more information.

If you need ground fault protection for hand-held equipment refer to the K896-1 GFCI Receptacle kit in the ACCESSORIES section of this manual for more information.

For recommended extension cord lengths and sizes see Table A.1.

CIRCUIT BREAKERS



The GX-271 machines are equipped with 50 amp circuit breakers on the 120/240 V receptacle and 15 amp circuit breakers on the 120 receptacles for overload protection. Under high heat a breaker may tend to trip at lower loads than it would normally.

CAUTION

Never bypass the circuit breakers. Without overload protection, the GX-271 could overheat and/or cause damage to the equipment being used.

PREMISES WIRING

The GX-271 is suitable for temporary, standby, or emergency power using the engine manufacturer's recommended maintenance schedule. With its three-wire grounded neutral generator, it can be permanently installed as a standby power unit for 240 volt, three wire, single phase 33 ampere service.

WARNING

Only a licensed, certified, trained electrician should install the machine to a premises or residential electrical system. Be certain that:

- The installation complies with the National Electrical Code and all other applicable electrical codes.
- The premises is isolated and no feedbacking into the utility system can occur. Certain state and local laws require the premises to be isolated before the generator is linked to the premises. Check your state and local requirements.
- A double pole, double throw transfer switch in conjunction with the properly rated double throw circuit breaker is connected between the generator power and the utility meter.

The following information and the connection diagram, Figure A.1, can be used as a guide by the electrician for most applications to premises wiring.

1. Install a double pole, double throw switch between the power company meter and the premises disconnect. **The switch rating must be the same as or greater than the premises disconnect and service overcurrent protection.**
2. Take the necessary steps to assure that the load is limited to the capacity of the GX-271 by installing a 35 amp 240 volt double pole circuit breaker. Maximum rated load for the 240 volt auxiliary is 33 amperes. Loading above 33 amperes will reduce output voltage below the allowable -10% of rated voltage. This may damage appliances or other motor-driven equipment.
3. Install a 50 amp 120/240 volt plug (NEMA type 14-50) to a double pole circuit breaker using No. 8 or larger, 4 conductor cable of the desired length. (The 50 amp 120/240 volt plug is available in the optional power plug kit.)
4. Plug this cable in to the 50 amp 120/240 volt receptacle on the GX-271 case front.

Table A.1
Extension Cord Length Recommendations

Current (Amps)	Voltage (Volts)	Load (Watts)	Maximum Allowable Cord Length in ft (m) for Conductor Size (AWG)											
			14 AWG		12 AWG		10 AWG		8 AWG		6 AWG		4 AWG	
15	120	1800	30	(9)	40	(12)	75	(23)	125	(38)	175	(53)	300	(91)
15	240	3600	60	(18)	75	(23)	150	(46)	225	(69)	350	(107)	600	(183)
20	240	4800			60	(18)	100	(30)	175	(53)	275	(84)	450	(137)
25	240	600					90	(27)	150	(46)	225	(69)	250	(76)
30	240	7200					75	(23)	120	(37)	175	(53)	300	(91)
35	240	8400							100	(30)	150	(46)	250	(76)

Figure A.1
CONNECTION OF GX-271 TO PREMISES WIRING

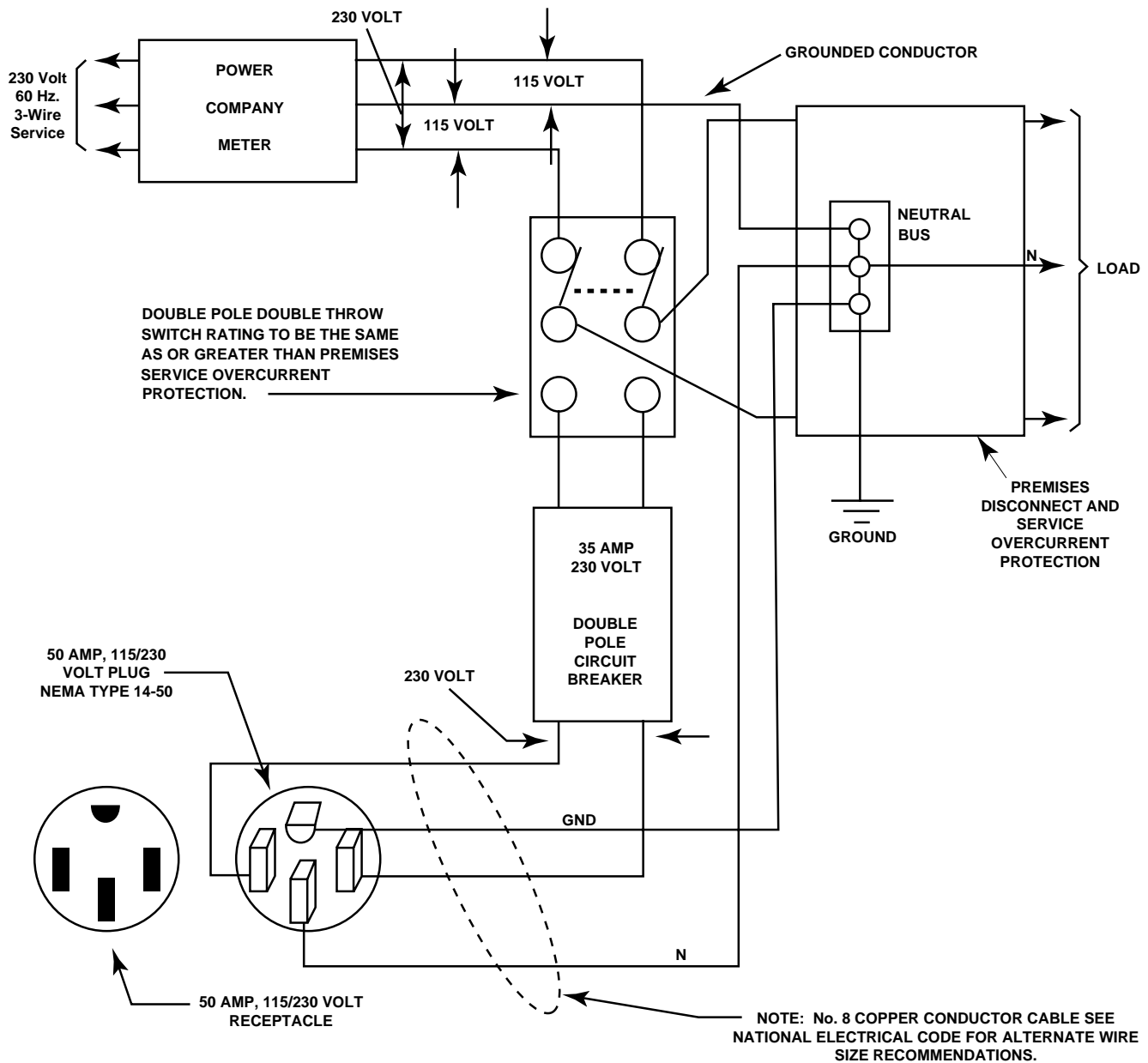

⚠ WARNING

Connection of GX-271 to premises wiring must be done by a licensed electrician and must comply with the National Electrical Code and all other applicable electrical codes.

OPERATING INSTRUCTIONS

Read and understand this entire section before operating your GX-271.

SAFETY INSTRUCTIONS

⚠ WARNING

Do not attempt to use this equipment until you have thoroughly read all operating and maintenance manuals supplied with your machine. They include important safety precautions, detailed engine starting, operating and maintenance instructions and parts lists.



ELECTRIC SHOCK can kill.

- Do not touch electrically live parts such as output terminals or internal wiring.
- Insulate yourself from the work and ground.
- Always wear dry insulating gloves.



ENGINE EXHAUST can kill.

- Use in open, well ventilated areas or vent exhaust outside
- Do not stack anything near the engine.



MOVING PARTS can injure.

- Do not operate with doors open or guards off.
- Stop engine before servicing.
- Keep away from moving parts

Only qualified personnel should operate this equipment.

GENERAL DESCRIPTION

The GX-271 is an engine driven, multi-process DC arc welder and AC power generator for commercial and residential applications. As a generator it can supply up to 8,000 continuous watts of 120/240 volt, 60 Hz, single-phase AC power to operate AC power tools, battery chargers, and lighting; it can also be used to provide standby power. As a welder it provides up to 300 amps of DC current for DC stick welding and DC semiautomatic wire feed welding. The GX-271 can also perform DC TIG welding.

DESIGN FEATURES

FOR WELDING:

- DC constant current output for stick and TIG welding - Two continuous CC output settings of 20 to 300 amps, one for general purpose stick and tig welding and one with a fixed controlled slope for out of position and pipe welding. The STICK-TIG mode includes an arc force control.
- DC constant voltage output for MIG and Flux Cored wire welding - One continuous CV welding range of 11 to 32 volts. Excellent MIG welding with CO₂ and blended gas. A pinch control allows the arc to be fine tuned from "soft" to "crisp". The recommended wire feeder is the K446 LN-25 with the K624-1 42 Volt Remote Output Control Module or the K449 LN-25 with an internal contactor.
- 100% duty cycle at 275 amps output.
- Remote control capability. Nine pin and fourteen pin connectors for easy connection of Lincoln wire feeders and remote control accessories. The 14 pin connector includes power for 42 VAC wire feeders.
- Internal "Solid State" contactor allows for the selection of "hot" or "cold" output terminals.

FOR AUXILIARY POWER

- 8,000 watts of 240 V AC, 60Hz auxiliary power.
- Power for tools, 120/240 lights, electric pumps and for standby emergency power.
- Power a 1-1/2 HP motor (provided it is started under no load).
- Two 15 amp industrial grade 120 V AC duplex receptacles for up to 60 amps of 120 VAC power.

- One 50 amp 120/240 V AC, single phase power, dual voltage receptacle with two 35 amp circuit breakers. Supplies up to 33 amps of 240 V AC and up to 66 amps of 120 V AC single phase auxiliary power per side to separate branch circuits (not in parallel). Allows easy connection to premises wiring.
- Welding and AC auxiliary power at the same time (within machine total capacity).

OTHER FEATURES

- Overhead valve, V-twin, 20 HP gasoline engine. Designed for long life, easy maintenance and excellent fuel economy.
- Engine protection system shuts the engine down with low oil pressure.
- Large maintenance-free battery. Group 58 with 435 cold cranking amps.
- Battery charging ammeter.
- Engine hour meter.
- Extended range 9 U.S. gallon (7.5 Imp. Gal., 34 liters) fuel tank.
- Automatic idler reduces engine speed when not welding or drawing auxiliary power. This feature reduces fuel consumption and extends engine life.
- Compact size fits crosswise in compact size pick-up truck.
- Copper alternator windings for dependability and long life.
- CSA approved.

RECOMMENDED APPLICATIONS

WELDER

The GX-271 provides excellent constant current DC welding output for stick (SMAW) welding and for TIG welding, and it offers constant voltage output for DC semiautomatic wire feed welding.

GENERATOR

The GX-271 gives AC power output for medium use demands.

LIMITATIONS

- The GX-271 is **not recommended** for any processes besides those that are normally performed using stick welding (SMAW), TIG welding (GTAW), MIG (GMAW) welding and Innershield® (FCAW) welding.
- The GX-271 is **not recommended** for pipe thawing.
- During welding, generator power is limited and output voltages can drop. Therefore, **DO NOT OPERATE ANY SENSITIVE ELECTRICAL EQUIPMENT WHILE YOU ARE WELDING.** See Table B.4 for permissible simultaneous welding and auxiliary power loads.

ADDITIONAL SAFETY PRECAUTIONS

Always operate the welder with the roof and case sides in place as this provides maximum protection from moving parts and assures proper cooling air flow.

Read and understand all Safety Precautions before operating this machine. Always follow these and any other safety procedures included in this manual and in the Engine Owner's Manual.

Only qualified personnel should install, use, or service this equipment.

CONTROLS AND SETTINGS

All generator/welder controls are located on the Output Control Panel of the machine case front. Idler control, and start/stop controls are also on the case front. See Figure B.1 and the explanations that follow.

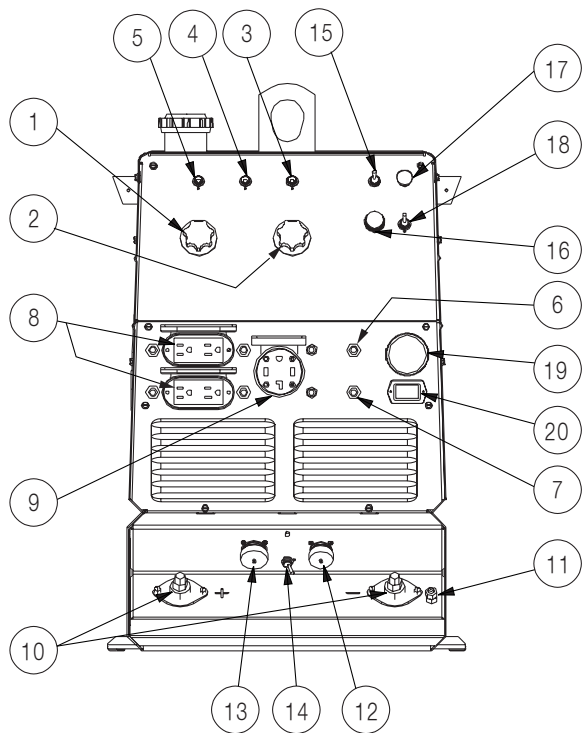

FIGURE B.1
OUTPUT PANEL CONTROLS

WELDER/GENERATOR CONTROLS

See Figure B.1 for the location of the following features:

1. **OUTPUT CONTROL:** Allows full range adjustment of welding current or voltage.
2. **ARC CONTROL:** The "ARC CONTROL" potentiometer is active in two modes: "STICK/TIG" and "WIRE WELDING" with different purposes in each mode.
3. **MODE SWITCH:** Selects three possible modes of welding operation, 1.) CC Stick/Tig welding, 2.) Pipe welding, and 3.) CV Wire Welding.
4. **LOCAL/REMOTE CONTROL SWITCH:** Allows the operator to control welding output at the welding control panel or at a wire feeder, TIG amptrol, or a K857 remote control.
5. **WELDING TERMINALS SWITCH:** The toggle switch labeled "WELDING TERMINALS ALWAYS ON" and "WELDING TERMINALS REMOTELY CONTROLLED" is used to control the operation of the solid state output contactor. With the switch in the "WELDING TERMINALS ALWAYS ON" position, the contactor is closed at low and high idle.
6. **BATTERY CHARGER CIRCUIT BREAKER:** Opens the engine battery circuit if a short develops. Engine will not crank if this circuit breaker is open.
7. **WIRE FEEDER POWER CIRCUIT BREAKER:** Opens the wire feeder circuit and disables the feeder if a fault is detected in the circuit.
8. **15 AMP, 120 VOLT DUPLEX RECEPTACLES:** Connection point for supplying 120 volt power to operate one or more electrical devices.
9. **50 AMP, 120/240 VOLT RECEPTACLE:** Connection point for supplying 240 volt power to operate one electrical device.
10. **WELD OUTPUT TERMINALS WITH FLANGE NUT:** Provides the connection point for the electrode and work cables.
11. **GROUND STUD:** Provides a connection point for connecting the machine case to earth ground for the safest grounding procedure.
12. **6 PIN AMPHENOL:** For attaching optional remote control equipment to the GX-271.
13. **14 PIN AMPHENOL:** For attaching wire feeder control cables to the GX-271 (Includes contactor closure circuit, remote control circuit, wire feeder 115/42 volt power source).
14. **WIRE FEEDER VOLTMETER POLARITY SWITCH:** matches polarity of wire feeder voltmeter to polarity of electrode.
15. **ENGINE RUN-STOP SWITCH:** Energizes engine circuit.
16. **ENGINE START PUSHBUTTON SWITCH:** Energizes starter solenoid contactor and fuel solenoid.
17. **ENGINE CHOKE**
18. **AUTO IDLER SWITCH:** In the "AUTO" mode, the engine goes to low idle speed 12 seconds after a welding or auxiliary power load is removed. Engine goes to high speed when the load is re-applied.
19. **BATTERY CHARGER AMMETER**
20. **ENGINE HOUR METER**

ENGINE OPERATION

WARNING

DO NOT RUN THE ENGINE AT EXCESSIVE SPEEDS. The maximum allowable high idle speed for the GX-271 is 3750 RPM, no load. Do NOT adjust the governor screw on the engine. Severe personal injury and damage to the machine can result if it is operated at speeds above the maximum rated speed.

Read and understand all safety instructions included in the Engine Owner's manual that is shipped with your GX-271.

BEFORE STARTING THE ENGINE

Check the engine oil level:



1. Be sure the machine is on a level surface.
2. Remove the engine oil dipstick and wipe it with a clean cloth. Reinsert the dipstick and check the level on the dipstick.
3. Add oil (if necessary) to bring the level up to the full mark. Do not overfill.
4. See Engine Owner's Manual for specific oil recommendations.

Check and fill the engine fuel tank:



WARNING



GASOLINE can cause fire or explosion.

- Stop engine when fueling.
- Do not smoke when fueling.
- Do not overfill tank.
- Avoid contact with skin or breathing of vapor.
- Keep sparks and flame away from tank.



1. Remove the fuel tank cap.
2. Fill the tank approximately 4 inches (100 mm) from the top of the filler neck to allow for fuel expansion (observe the fuel gauge.) DO NOT FILL THE TANK TO THE POINT OF OVERFLOW.
3. Replace the fuel tank cap and tighten securely.
4. See Engine Owner's Manual for fuel recommendations.

STARTING THE ENGINE

CAUTION

Be sure all Pre-Operation Maintenance has been performed. See the INSTALLATION section.

Remove all loads connected to the AC power receptacles and the welder before starting the diesel engine.

To start the engine, set the "IDLER" switch in the "AUTO" ( / ) position. Pull the choke control out.

Place the "Engine" Switch in the "RUN"  Position. Push the "Start" button and crank the engine until it starts. Release the button as soon as the engine starts. After the engine has started, slowly return the choke control to the full "in" position (choke open). In the "AUTO" position, the engine will run at high idle for 10-14 seconds and then go to low idle. Allow the engine to warm up by letting it run at low idle for a few minutes.

At cold temperatures, it may be necessary to start the engine in "HIGH" idle and allow it to run for several minutes before using "AUTO" idle.

When starting a hot engine, it is not necessary to pull the choke out but the engine will start faster if it is pulled out. Push it in immediately after the engine starts.

CAUTION

Operating the starter motor for more than 5 seconds can damage the motor. If the engine fails to start, release the switch and wait 10 seconds before operating the starter again. Do not push the "Start" button while the engine is running because this can damage the ring gear and/or starter motor.

NOTE: When starting a GX-271 for the first time, after an extended period of not operating, it will take longer than normal because the fuel pump has to fill the fuel line and carburetor.

STOPPING THE ENGINE

Remove all welding and auxiliary power loads and allow the engine to run at low idle speed for a few minutes to cool the engine.

Stop the engine by placing the "Engine" switch in the "STOP" position.

A fuel shut off valve is not required on the GX-271 because the fuel tank is mounted below the engine.

**TABLE B.1
TYPICAL GX-271 FUEL CONSUMPTION**

	K1624-1 GX-271 Honda Engine	K1624-2 GX-271 Kohler Engine
Low Idle - No Load 2400 RPM	.35 US gallons/hour (.29 Imp. gal./hr., 1.31 liters/hour)	.40 US gallons/hour (.34 Imp. gal./hr., 1.53 liters/hour)
High Idle - No Load 3700 RPM	.76 US gallons/hour (.63 Imp. gal./hr., 2.86 liters/hour)	.87 US gallons/hour (.73 Imp. gal./hr., 3.30 liters/hour)
210 Amps @ 25 Volts DC Weld Output	1.21 US gallons/hour (1.01 Imp. gal./hr., 4.57 liters/hour)	1.27 US gallons/hour (1.06 Imp. gal./hr., 4.82 liters/hour)
250 Amps @ 25 Volts DC Weld Output	1.40 US gallons/hour (1.17 Imp. gal./hr., 5.30 liters/hour)	1.37 US gallons/hour (1.14 Imp. gal./hr., 5.17 liters/hour)
275 Amps @ 25 Volts DC Weld Output	1.53 US gallons/hour (1.27 Imp. gal./hr., 5.79 liters/hour)	1.44 US gallons/hour (1.20 Imp. gal./hr., 5.45 liters/hour)
275 Amps @ 28 Volts DC Weld Output	1.67 US gallons/hour (1.39 Imp. gal./hr., 6.32 liters/hour)	1.53 US gallons/hour (1.28 Imp. gal./hr., 5.80 liters/hour)
8,000 kVA Auxiliary Power	1.56 US gallons/hour (1.30 Imp. gal./hr., 5.89 liters/hour)	1.47 US gallons/hour (1.22 Imp. gal./hr., 5.55 liters/hour)

WELDING OPERATION

⚠ WARNING

Do not attempt to use this equipment until you have thoroughly read the engine manufacturer's manual supplied with your welder. It includes important safety precautions, detailed engine starting, operating and maintenance instructions, and parts lists.



ELECTRIC SHOCK can kill.

- Do not touch electrically live parts or electrode with skin or wet clothing.
- Insulate yourself from work and ground
- Always wear dry insulating gloves.



FUMES AND GASES can be dangerous.

- Keep your head out of fumes.
- Use ventilation or exhaust to remove fumes from breathing zone.



MOVING PARTS can injure.

- Do not operate with doors open or guards off.
- Stop engine before servicing.
- Keep away from moving parts.

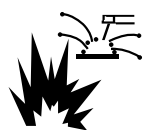

WELDING SPARKS can cause fire or explosion.

- Keep flammable material away.



ARC RAYS can burn.

- Wear eye, ear and body protection.

See additional warning information throughout this operator's manual.

WELDER CONTROLS - FUNCTION AND OPERATION

See Figure B.1 for control locations.

Output "CONTROL"

Continuous CC welding current control from 20 amps to 300 amps in the STICK/TIG and PIPE modes. Continuous CV welding arc voltage control from 11 volts to 32 volts in the WIRE FEED mode.

"ARC CONTROL"

The "ARC CONTROL" is active in two modes: "STICK/TIG" and "WIRE WELDING" and has different

purposes in each mode. It is not active in the "PIPE" mode.

"STICK/TIG" mode: In this mode, the "ARC CONTROL" knob sets the short circuit (arc force) current during stick welding. Increasing the number from 1 to 10 increases the short circuit current. This prevents sticking of the electrode to the plate at low welding current settings. This also increases spatter. It is recommended that the control is set to the minimum number without electrode sticking.

"WIRE WELDING" mode: In this mode, increasing the number from 1 to 10 changes the arc from soft and washed in to crisp and narrow. It acts as an inductance control. The proper setting depends on the application and operator preference. In general, Mig welding performs best in the "SOFT" range and Innershield in the "CRISP" range.

"LOCAL" / "REMOTE" Switch



The toggle switch on the control panel labeled "LOCAL/REMOTE" gives the operator the option of controlling the output at the welder control panel or at a wire feeder, TIG amptrol, or a K857 Remote Control that is connected to either the 6 pin or 14 pin amphenol connector.

For remote control the toggle switch is set in the "REMOTE" position.

For control at the welder control panel, the toggle switch is set in the "LOCAL" position.

"WELDING TERMINALS" Switch

The toggle switch on the control panel labeled "WELDING TERMINALS ALWAYS ON" and "WELDING TERMINALS REMOTELY CONTROLLED", is used to control the operation of the solid state contactor which allows for the selection of "Hot" or "Cold" welding terminals.

With the switch in the "WELDING TERMINALS ALWAYS ON" position, the contactor is closed and the welding terminals are always "Hot."

With the switch in the "WELDING TERMINALS REMOTELY CONTROLLED" position, the contactor operation is controlled by an Amptrol, Arc Start Switch or some other type of triggering device through the use of a control cable connected to the 6 pin or 14 pin amphenol.



When the triggering device is pressed the contactor is closed and the welding terminals are "Hot."

When the triggering device is released the contactor is opened and the welding terminals are "Cold."

"MODE" Switch - Set to the desired process: STICK/TIG, PIPE, or WIRE FEED.

"WIRE FEEDER VOLTMETER" Switch - If using a wire feeder that has a voltmeter, set this switch to match the polarity of the electrode.

STICK WELDING

The GX-271 can be used with a broad range of DC stick electrodes. The output "CONTROL" adjusts the full range of 20 to 300 amps. Set the "ARC CONTROL" to low setting to minimize spatter. If sticking is a problem, turn this control to a higher setting (clockwise). This will increase the short circuit current (arc force).

PIPE WELDING

The "PIPE WELDING" mode is recommended for manual vertical-down techniques on pipe joints using EXX10 type electrodes. This slope controlled setting allows the operator to control the welding current by changing the arc length.

The "ARC CONTROL" (arc force) is automatically switched off in this mode.

TIG WELDING

The GX-271 can be used in a wide variety of DC Tungsten Inert Gas (TIG) welding applications. When used with the K930-1 or -2 TIG module, ratings are limited to 275A at a 60% duty cycle and 250A at a 80% duty cycle.

GX-271 settings when using the K930-1 or -2 Tig Module:

- a. Set the "MODE" Switch to the STICK/TIG setting.
- b. Set the "IDLER" Switch to the "AUTO" position.
- c. Set the "LOCAL/REMOTE" switch to the "REMOTE" position.
- d. Set the "WELDING TERMINALS" switch to the "WELDING TERMINALS REMOTELY CONTROLLED" position. This will keep the "Solid State" contactor open and provide a "cold" electrode until the triggering device (Amptrol or Arc Start Switch) is pressed.
- e. Set the "ARC CONTROL" to minimum.

See Table B.2 for Typical Current Ranges for Tungsten Electrodes.

Table B.2 TYPICAL CURRENT RANGES ⁽¹⁾ FOR TUNGSTEN ELECTRODES ⁽²⁾

Tungsten Electrode Diameter in. (mm)	DCEN (-)	DCEP (+)	Approximate Argon Gas Flow Rate C.F.H. (l/min.)		TIG TORCH Nozzle Size (4), (5)
	1%, 2% Thoriated Tungsten	1%, 2% Thoriated Tungsten	Stainless Steel		
0.010 (.25)	2-15	(3)	3-8	(2-4)	#4, #5, #6
0.020 (.50)	5-20	(3)	5-10	(3-5)	
0.040 (1.0)	15-80	(3)	5-10	(3-5)	
1/16 (1.6)	70-150	10-20	9-13	(4-6)	#5, #6
3/32 (2.4)	150-250	15-30	11-15	(5-7)	#6, #7, #8
1/8 (3.2)	250-400	25-40	11-15	(5-7)	
5/32 (4.0)	400-500	40-55	13-17	(6-8)	#8, #10
3/16 (4.8)	500-750	55-80	18-22	(8-10)	
1/4 (6.4)	750-1000	80-125	23-27	(11-13)	

(1) When used with argon gas. The current ranges shown must be reduced when using argon/helium or pure helium shielding gases.

(2) Tungsten electrodes are classified as follows by the American Welding Society (AWS):

Pure	EWP
1% Thoriated	EWTh-1
2% Thoriated	EWTh-2

Though not yet recognized by the AWS, Ceriated Tungsten is now widely accepted as a substitute for 2% Thoriated Tungsten in AC and DC applications.

(3) DCEP is not commonly used in these sizes.

(4) TIG torch nozzle "sizes" are in multiples of 1/16ths of an inch:

# 4 = 1/4 in.	(6 mm)
# 5 = 5/16 in.	(8 mm)
# 6 = 3/8 in.	(10 mm)
# 7 = 7/16 in.	(11 mm)
# 8 = 1/2 in.	(12.5 mm)
#10 = 5/8 in.	(16 mm)

(5) TIG torch nozzles are typically made from alumina ceramic. Special applications may require lava nozzles, which are less prone to breakage, but cannot withstand high temperatures and high duty cycles.

WIRE WELDING

Connect a wire feeder to the GX-271 and set welder controls according to the instructions on the appropriate wire feeder connection diagram.

The GX-271 in the "WIRE FEED" position, permits it to be used with a broad range of flux cored wire (Innershield and Outershield) electrodes and solid wires for MIG welding (gas metal arc welding). Welding can be finely tuned using the "ARC CONTROL".

Some recommended Innershield electrodes are: NR-311, NS-3M, NR-207, NR-203 Ni 1%, NR-204-H.

Recommended Outershield electrodes are: OS-70, OS-71M.

Some recommended solid wires for MIG welding are: .035 (0.9 mm) and .045 (1.1 mm) L-50, L-56, and Blue Max MIG 308 LS.

For any electrodes, including the above recommendations, the procedures should be kept within the rating of the machine. For additional electrode information, see Lincoln publications N-675, GS-100 and GS-210.

**TABLE B.3
SUMMARY OF WELDING PROCESSES AND MACHINE SETTINGS**

PROCESS	CONTROL CABLE USED	MODE SWITCH	IDLER SWITCH	OUTPUT CONTROL SWITCH	WELDING TERMINALS SWITCH	ELECTRODE WHEN NOT WELDING	TO START WELDING
STICK - CC	NO	STICK/TIG or PIPE	AUTO	LOCAL	WELDING ON	HOT	Touch electrode to work. Welding starts immediately and engine goes to high idle.
TIG - CC K930-1 TIG MODULE / K936-1 CONTROL CABLE (With Amptrol)	YES	STICK/TIG	AUTO	REMOTE	CONTACTOR CONTROLLED	COLD	Press Amptrol. GX-271 contactor closes. Welding starts immediately and engine goes to high idle.
WIRE FEED - CV, LN-25 WITH 42V REMOTE CONTROL KIT	YES	WIRE FEED	AUTO	REMOTE	CONTACTOR CONTROLLED	COLD	Press gun trigger, GX-271 contactor closes. Welding starts immediately and engine goes to high idle.
WIRE FEED - CV, LN-25 WITH INTERNAL CONTACTOR	NO	WIRE FEED	AUTO	LOCAL	WELDING ON	COLD	Press gun trigger, LN-25 contactor closes. Welding starts immediately and engine goes to high idle.
WIRE FEED - CV, LN-742	YES	WIRE FEED	AUTO	REMOTE	CONTACTOR CONTROLLED	COLD	Press gun trigger, GX-271 contactor closes. Welding starts immediately and engine goes to high idle.
WIRE FEED - CV, LN-7	YES	WIRE FEED	HIGH	REMOTE	CONTACTOR CONTROLLED	COLD	Press gun trigger, GX-271 contactor closes. Welding starts immediately.

AUXILIARY POWER

Start the engine and set the "IDLER" control switch to the desired operating mode. Full power is available regardless of the welding output settings, if no welding current is being drawn.

The auxiliary power of the GX-271 consists of two 15 Amp-120VAC (5-15R) duplex receptacles and one 50 Amp 120/240 VAC (14-50R) receptacle.

The auxiliary power capacity is 8,000 watts of 60 Hz, single phase power. The auxiliary power capacity rating in watts is equivalent to volt-amperes at unity power factor. The max permissible current of the 240 VAC output is 33 Amps. The 240 VAC output can be split to provide two separate 120 VAC outputs with a max permissible current of 33 Amps per output to two separate 120 VAC branch circuits. Output voltage is within $\pm 10\%$ at all loads up to rated capacity.

The 120V duplex auxiliary power receptacles should only be used with three wire grounded type plugs or approved double insulated tools with two wire plugs.

The current rating of any plug used with the system must be at least equal to the current capacity of the associated receptacle.

NOTE: The 240V receptacle has two circuits, each of which measure 120 V to neutral but are of opposite polarities and cannot be paralleled.

SIMULTANEOUS WELDING AND POWER LOADS

It must be noted that the above auxiliary power ratings are with no welding load. Simultaneous welding and power loads are specified in the following table. The permissible currents shown assume that current is being drawn from either the 120 VAC or 240 VAC supply (not both at the same time).

**TABLE B.4
GX-271 SIMULTANEOUS WELDING AND POWER LOADS**

Welding Output Amps	Arc Voltage	Available Auxiliary Power - Watts (Unity Power Factor)	Permissible Auxiliary Current in Amperes @ 120V	Permissible Auxiliary Current in Amperes @ 240V
0	0	8000	66	33
50	25	7400	62	31
100	25	6300	52	26
150	25	4800	40	20
200	25	3400	28	14
250	25	1800	15	7.5
275	25	1000	8	4
275	28	0	0	0

GENERAL OPTIONS / ACCESSORIES

The following options/accessories are available for your GX-271:

K886-1 Canvas Cover - To protect the GX-271 when it is not being operated. Made from attractive red canvas material that is flame retardant, mildew resistant and water repellent.

K889-2 Two Wheel Undercarriage - For moving by hand. Two 4.00" x 8" pneumatic tires. Overall width 29" (.74m).

K893-1 Caster for K889-2 Undercarriage - Mounts to the front of the Two-Wheel undercarriage to allow easy movement on smooth surfaces. Includes a 6" diameter hard rubber wheel with a convenient toe-on, toe-off locking brake.

K933-1 Four Wheel Undercarriage - Allows movement of the GX-271 by hand without lifting on smooth surfaces. Includes two rugged, hard molded wheels and two durable pneumatic tires. The spring loaded handle provides convenient, comfortable steering. The K934-1 Bracket is available for mounting a gas cylinder on the undercarriage.

K934-1 Bracket for Mounting a Gas Cylinder to a K933-1 Undercarriage - Easily mounts on the back of the K933-1 Four Wheel Undercarriage to carry a welding gas cylinder.

K957-1 Two-Wheeled Trailer - For in-plant or yard towing of the GX-271. Suitable for road towing with optional Fender and Light Kit. The following options are available for the K957-1 Two-Wheeled Trailer:

K958-1 - Ball Coupler 2"

K958-2 - Lunette Eye Coupler

K959-2 - Fender & Light

K965-1 - Cable Rack

K894-1 Spark Arrester Kit - A field installed kit for the GX-271 engine muffler exhaust pipe. Includes a heavy-gauge steel, approved spark arrester, mounting clamp and adapter.

K703 Accessory Kit - Includes the following:

- Thirty-five feet (10.5 meters) of # 1/0 AWG electrode cable.
- Thirty feet (9.1 meters) of # 1/0 AWG work cable.
- Headshield with No. 12 filter.

- GC500 work clamp.

- Cooltong® 300 insulated electrode holder.

K802-R Power Plug Kit - Provides four 15 amp, 120 volt plugs and one 50 amp, dual voltage 120/240V, full kVA plug.

K857 Remote Control - Includes a control box with 25 feet (7.5 meters) of 4-conductor cable. Allows output voltage to be controlled remotely.

K857-1 Remote Control - Includes a control box with 100 feet (30.5 meters) of 4-conductor cable. Allows output voltage to be controlled remotely.

K896-1 GFCI Receptacle Kit - Includes two UL approved 120 volt ground fault circuit interrupter receptacles (duplex type) with covers and installation instructions. Each receptacle is rated 15 amps, but the maximum total current from each GFCI duplex is limited to 20 amps. The GFCI receptacles replace the two factory installed 120 volt duplex receptacles.

TIG WELDING OPTIONS / ACCESSORIES

K930-1 TIG Module - The TIG Module is an accessory that provides high frequency and shielding gas control for AC and DC GTAW (TIG) welding applications. It provides contactor control of constant current welding power sources having an internal contactor. The TIG Module is supplied without accessories, Arc Start switches, Amptrols, cables, torches and mounting brackets must be purchased separately.

K939-1 Docking Kit - For mounting the K930-1 TIG Module on top of the GX-271.

K936-1 Control Cable - Control cable for connecting the K930-1 TIG Module to a GX-271.

K814 Arc Start Switch - A remote start switch used in conjunction with the K930-1 TIG Module to energize the GX-271 output terminals via the TIG module.

K963 Hand Amptrol - Remote output control and contactor control.

K870 Foot Amptrol - Remote output control and contactor control.

SEMIAUTOMATIC FCAW AND MIG WELDING OPTIONS / ACCESSORIES

LN-25 Wire Feeder - This portable unit can be used for flux-cored arc welding (FCAW) and metal inert gas welding (MIG).

LN-7 Wire Feeder - Semiautomatic constant speed wire feeder.

NOTE: Gas-shielded welding requires a Magnum Gun. Gasless welding requires an Innershield Gun.

K487-25 Magnum Spool Gun - A lightweight, semi-automatic wire feeder for aluminum welding with argon gas. Has built-in remote wire speed control in the handle. Requires the K488 SG Control Module. Includes 50 feet (15.2 meters) of power cable.

K488 SG Control Module - Controls wire speed and gas flow. Provides the required control interface between the GX-271 and the K487-25 Magnum Spool Gun.

GX-271 / LN-25 ACROSS THE ARC CONNECTION DIAGRAM WITH OPTIONAL K857 REMOTE CONTROL

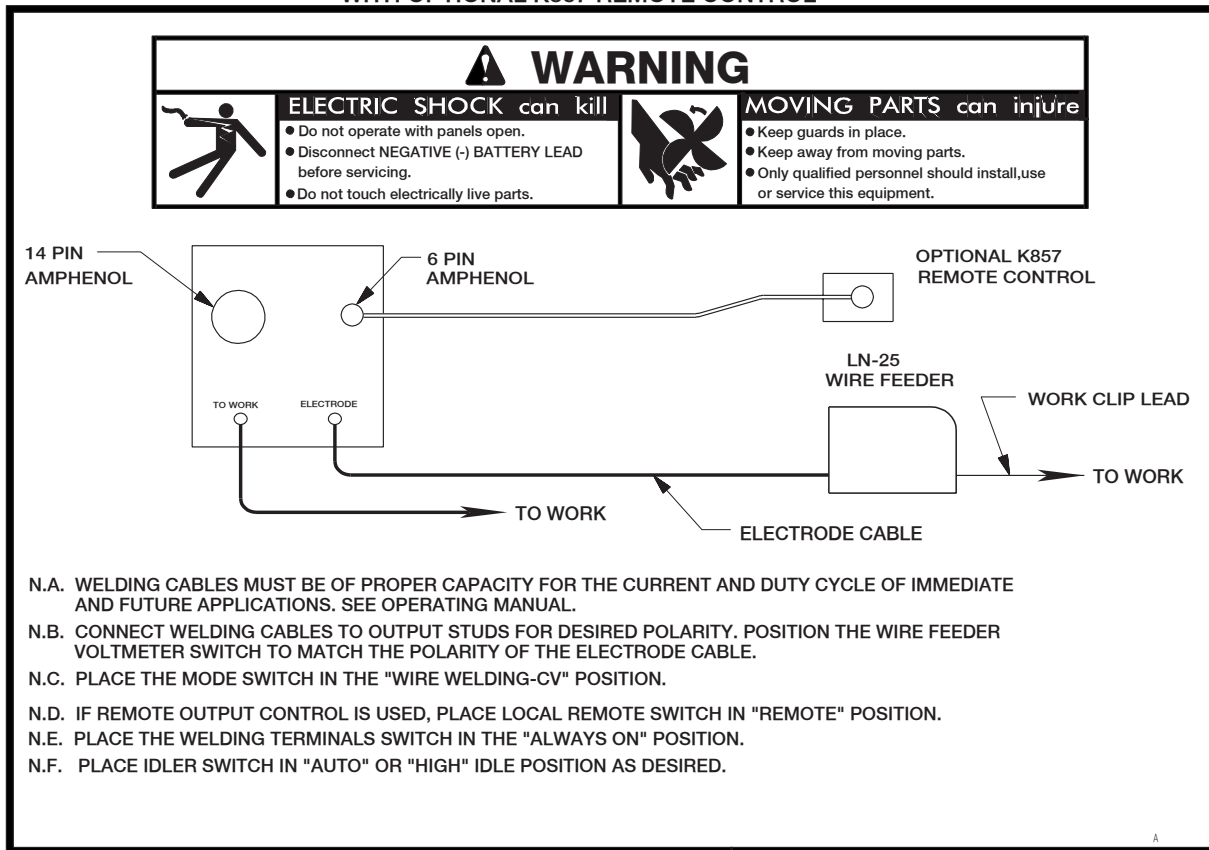

S24095-1

GX-271 / LN-25 ACROSS THE ARC CONNECTION DIAGRAM WITH OPTIONAL K444-1 REMOTE CONTROL

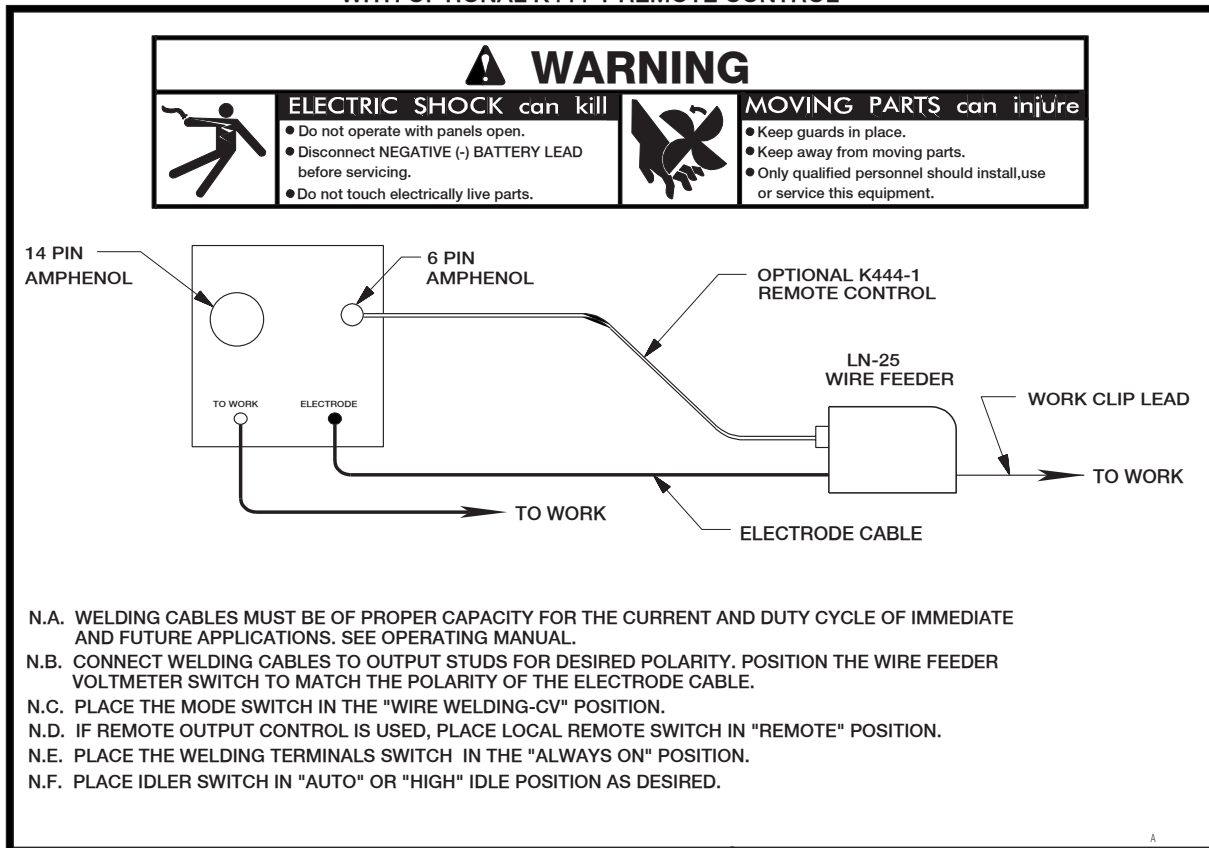

S24095-2

GX-271 / LN-25 WITH K624-1 42 VOLT REMOTE OUTPUT CONTROL MODULE CONNECTION DIAGRAM

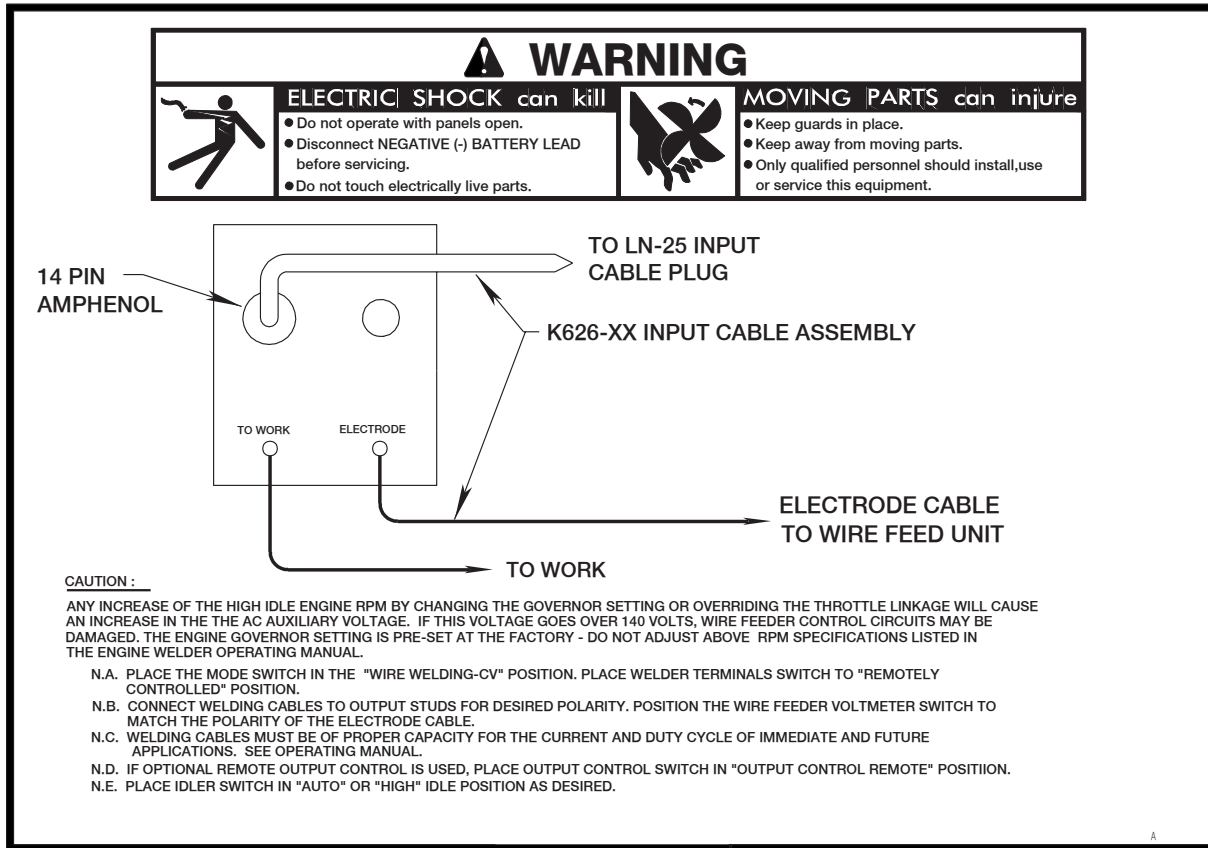

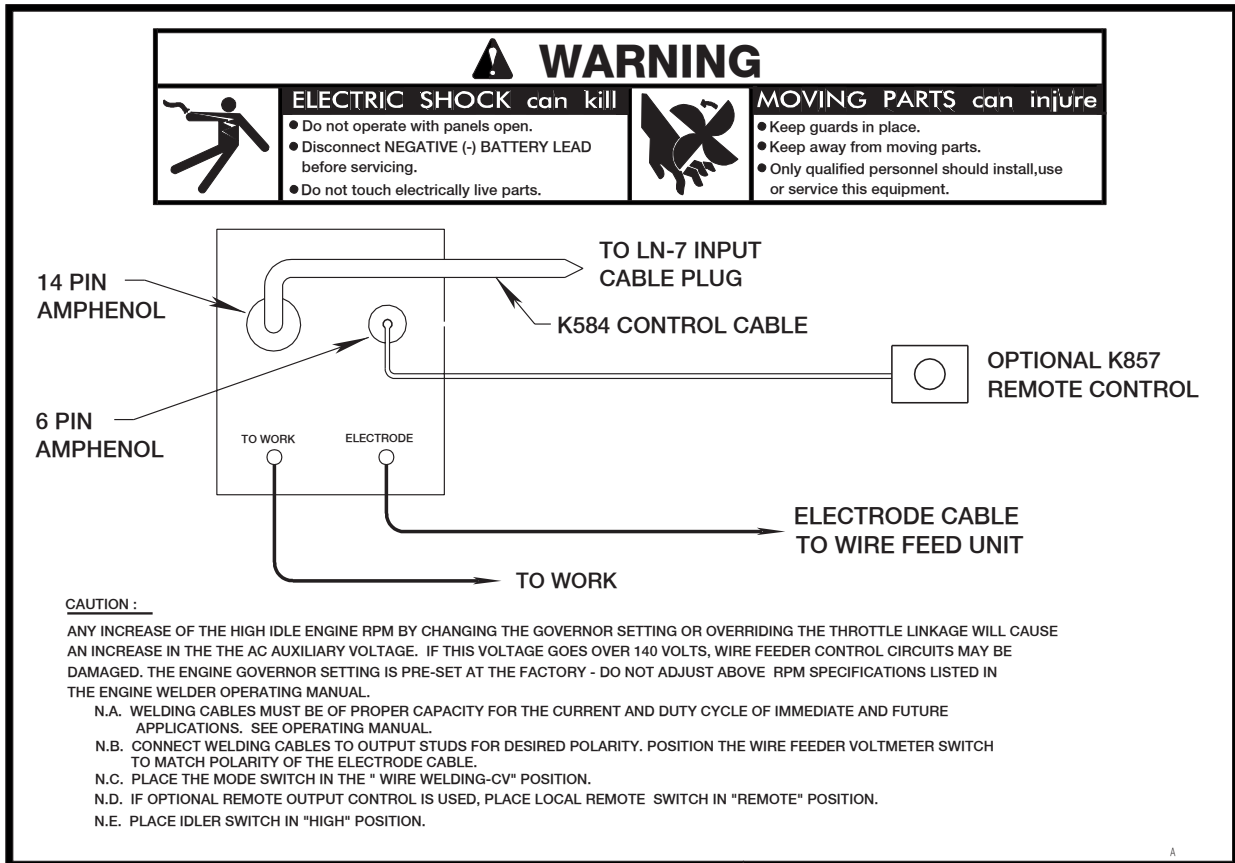

S24095-3

GX-271 / LN-7 CONNECTION DIAGRAM



S24095-4

GX-271 / LN-742 CONNECTION DIAGRAM

⚠ WARNING		
	ELECTRIC SHOCK can kill <ul style="list-style-type: none"> • Do not operate with panels open. • Disconnect NEGATIVE (-) BATTERY LEAD before servicing. • Do not touch electrically live parts. 	
MOVING PARTS can injure <ul style="list-style-type: none"> • Keep guards in place. • Keep away from moving parts. • Only qualified personnel should install, use or service this equipment. 		

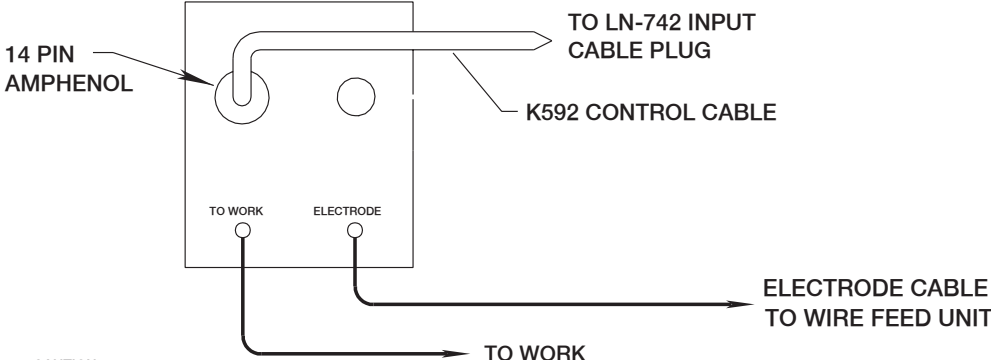

CAUTION :

ANY INCREASE OF THE HIGH IDLE ENGINE RPM BY CHANGING THE GOVERNOR SETTING OR OVERRIDING THE THROTTLE LINKAGE WILL CAUSE AN INCREASE IN THE THE AC AUXILIARY VOLTAGE. IF THIS VOLTAGE GOES OVER 140 VOLTS, WIRE FEEDER CONTROL CIRCUITS MAY BE DAMAGED. THE ENGINE GOVERNOR SETTING IS PRE-SET AT THE FACTORY - DO NOT ADJUST ABOVE RPM SPECIFICATIONS LISTED IN THE ENGINE WELDER OPERATING MANUAL.

N.A. WELDING CABLES MUST BE OF PROPER CAPACITY FOR THE CURRENT AND DUTY CYCLE OF IMMEDIATE AND FUTURE APPLICATIONS. SEE OPERATING MANUAL.

N.B. CONNECT WELDING CABLES TO OUTPUT STUDS FOR DESIRED POLARITY. POSITION THE WIRE FEEDER VOLTMETER SWITCH TO MATCH THE POLARITY OF THE ELECTRODE CABLE.

N.C. PLACE THE MODE SWITCH IN THE " WIRE WELDING-CV" POSITION.



N.D. PLACE WELDER TERMINALS SWITCH TO "REMOTELY CONTROLLED" POSITION.

N.E. IF OPTIONAL REMOTE OUTPUT CONTROL IS USED, PLACE OUTPUT CONTROL SWITCH IN "OUTPUT CONTROL REMOTE" POSITION.

N.F. PLACE IDLER SWITCH IN "AUTO" OR "HIGH" IDLE POSITION AS DESIRED.

A
S24095-5

GX-271 / LN-8 CONNECTION DIAGRAM

⚠ WARNING		
	ELECTRIC SHOCK can kill <ul style="list-style-type: none"> • Do not operate with panels open. • Disconnect NEGATIVE (-) BATTERY LEAD before servicing. • Do not touch electrically live parts. 	
MOVING PARTS can injure <ul style="list-style-type: none"> • Keep guards in place. • Keep away from moving parts. • Only qualified personnel should install, use or service this equipment. 		

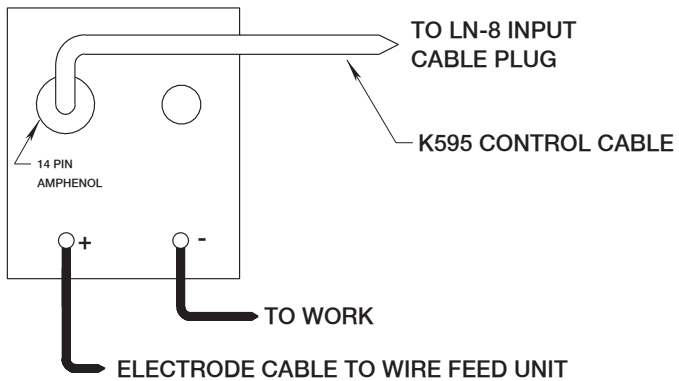

CAUTION :

ANY INCREASE OF THE HIGH IDLE ENGINE RPM BY CHANGING THE GOVERNOR SETTING OR OVERRIDING THE THROTTLE LINKAGE WILL CAUSE AN INCREASE IN THE THE AC AUXILIARY VOLTAGE. IF THIS VOLTAGE GOES OVER 140 VOLTS, WIRE FEEDER CONTROL CIRCUITS MAY BE DAMAGED. THE ENGINE GOVERNOR SETTING IS PRE-SET AT THE FACTORY - DO NOT ADJUST ABOVE RPM SPECIFICATIONS LISTED IN THE ENGINE WELDER OPERATING MANUAL.

N.A. WELDING CABLES MUST BE OF PROPER CAPACITY FOR THE CURRENT AND DUTY CYCLE OF IMMEDIATE AND FUTURE APPLICATIONS. SEE OPERATING MANUAL.

N.B. CONNECT WELDING CABLES TO OUTPUT STUDS FOR DESIRED POLARITY. POSITION THE WIRE FEEDER VOLTMETER SWITCH TO MATCH THE POLARITY OF THE ELECTRODE CABLE.

N.C. PLACE THE MODE SWITCH IN THE "WIRE WELDING-CV" POSITION. PLACE LOCAL / REMOTE SWITCH IN "REMOTE" POSITION.

N.D. PLACE IDLER SWITCH IN "HIGH" POSITION.

A
S24095-6

GX-271 TO K867 CONTROL CABLE ADAPTER CONNECTION DIAGRAM

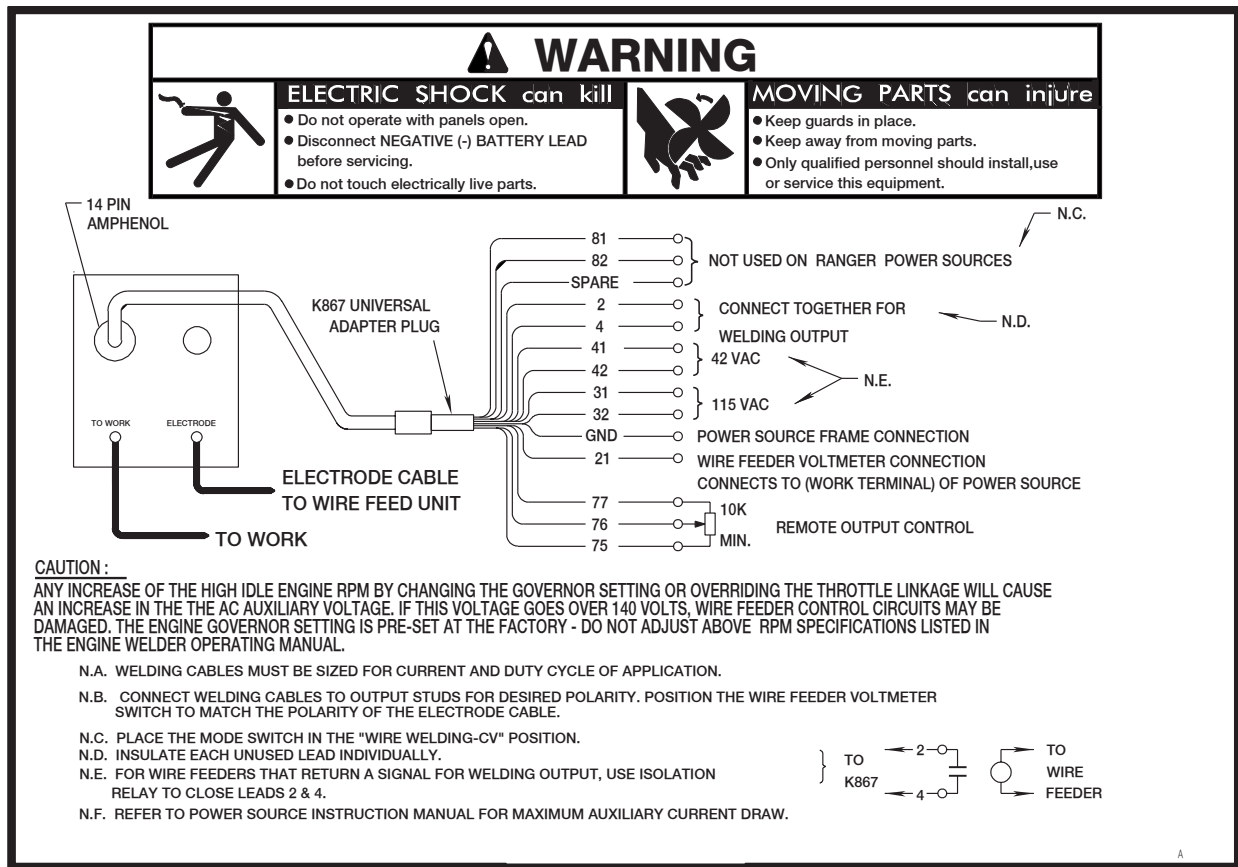

GX-271 / K691-10 / K488 / K487 SPOOL GUN CONNECTION DIAGRAM

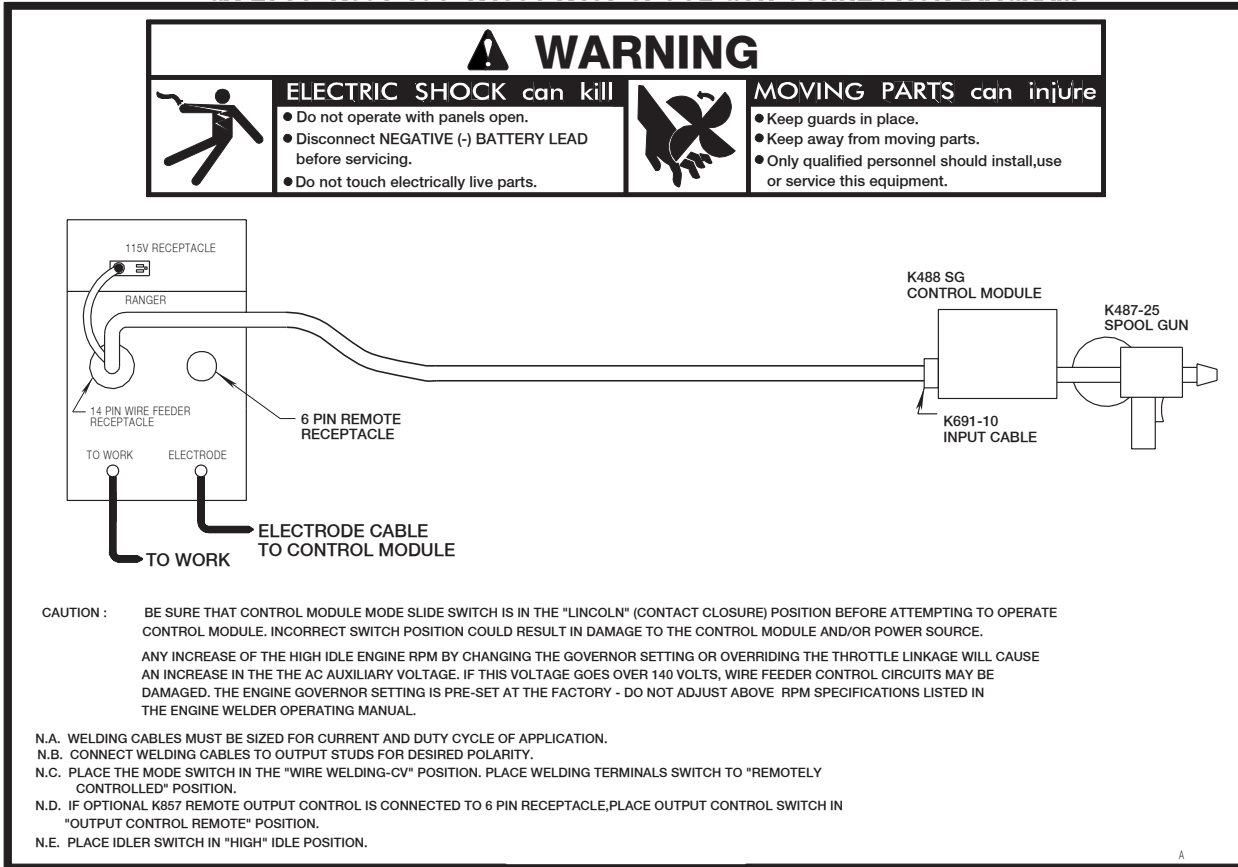

GX-271 / K930 TIG MODULE / CONNECTION DIAGRAM

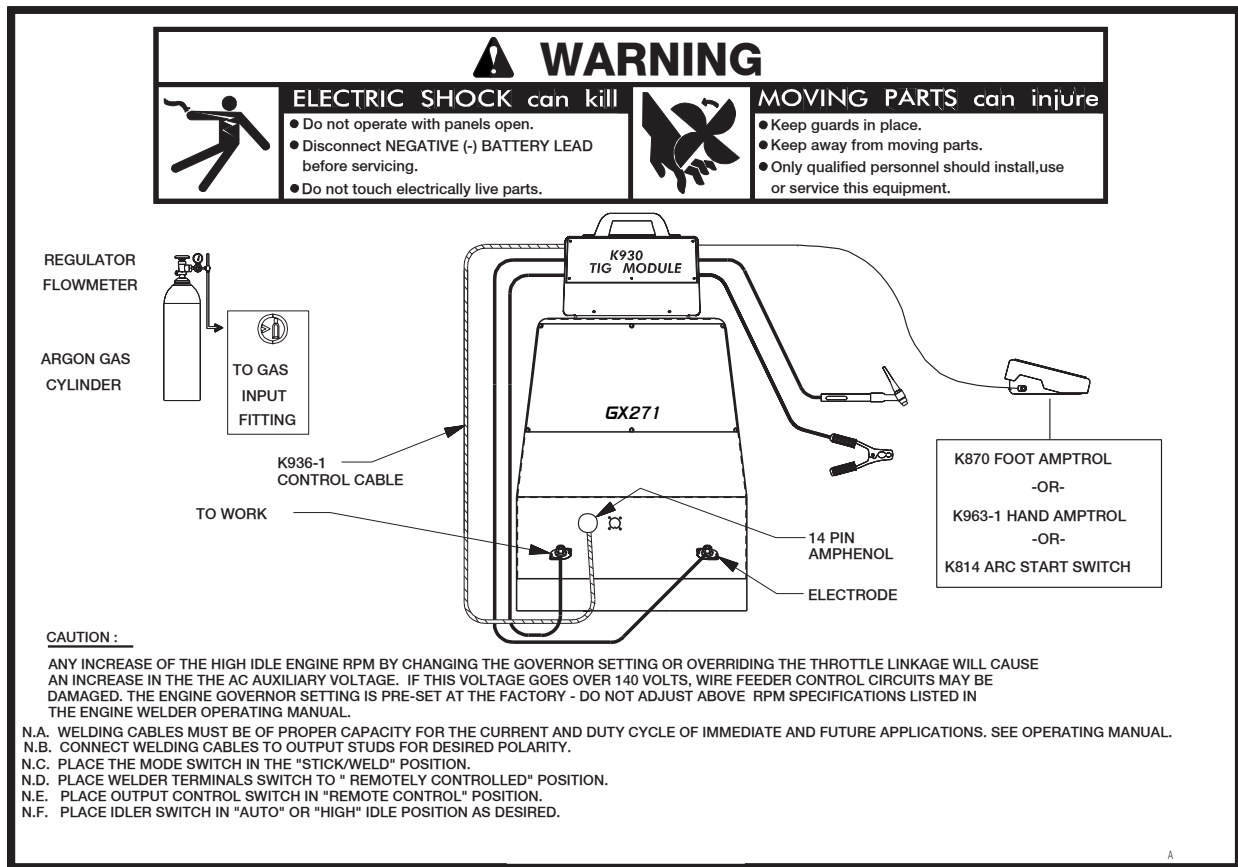

SAFETY PRECAUTIONS

⚠ WARNING

Have qualified personnel do the maintenance work. Turn the engine off before working inside the machine. In some cases, it may be necessary to remove safety guards to perform required maintenance. Remove guards only when necessary and replace them when the maintenance requiring their removal is complete. Always use the greatest care when working near moving parts.

Do not put your hands near any rotating parts. If a problem cannot be corrected by following the instructions, take the machine to the nearest Lincoln Field Service Shop.



ELECTRIC SHOCK can kill.

- Do not touch electrically live parts or electrode with skin or wet clothing.
- Insulate yourself from work and ground
- Always wear dry insulating gloves.



ENGINE EXHAUST can kill.

- Use in open, well ventilated areas or vent exhaust outside.



MOVING PARTS can injure.

- Do not operate with enclosure or guards off.
- Stop engine before servicing.
- Keep away from moving parts.

See additional warning information throughout this operator's manual and the Engine manual as well.

ROUTINE AND PERIODIC ENGINE MAINTENANCE

At the end of each day's use, refill the fuel tank to minimize moisture condensation in the tank. Running out of fuel tends to draw dirt into the fuel system. Also, check the crankcase oil level and add oil if indicated.

ENGINE MAINTENANCE PARTS

TABLE D.1

	HondaGX 620	Kohler CH 20
Oil Filter	Honda15400-PR3-004 (Honda Code 3179553) FramPH6811	Kohler 1205001 FramPH3614*
Air Filter	Honda 17211-ZJ1-000 (Honda Code 4209672)	Kohler 4708303 Fram CA79
Air Filter Pre-Cleaner	Honda 17218-ZJ1-000 (Honda Code 4209706)	Kohler 2408302
Fuel Filter	Honda 16910-ZE8-005 (Honda Code 2106235)	Kohler 2505002 Fram G1
SparkPlugs	NGK BPR6ES Nippondenso W20EPR-U .030in., (.76 mm.) gap	Champion RC12YC .030in., (.76 mm.) gap

* Oil capacity increases from 2.0 Qts. to 2.1 Qts when using this filter.

**TABLE D.2
HONDA ENGINE MAINTENANCE SCHEDULE**

Regular Service Period (3)		Each Use	First Month or 20 Hrs.	Every 3 Months or 50 Hrs.	Every 6 Months or 100 Hrs.	Every Year or 300 Hours
ITEM Perform at every indicated month or operating hour interval, whichever comes first.						
Engine Oil	Check Level	.				
	Change		.		.	
Engine Oil Filter	Replace					. or 200 Hours
Air Cleaner	Check	.				
	Clean			. (1)		
	Replace					. (2)
Spark Plug	Clean adjust				.	
	Replace					.
Spark Arrestor (Optional Part)	Clean				.	
Engine Speed	Check-Adjust					. (3)
Valve Clearance	Check-Readjust					. (3)
Fuel Filter	Check				.	
	Replace					. (3)
Fuel Line	Check (Replace if necessary)	Every 2 Years (3)				

- (1) Service more frequently when used in dusty areas.
 (2) Replace the paper element only.
 (3) These items should be services by an authorized engine dealer.

**TABLE D.3
KOHLER ENGINE MAINTENANCE SCHEDULE**

Regular Service Period (3)		Each Use	5 Hrs.	25 Hrs.	Every 100 Hrs.	Every 200 Hours
ITEM Perform at every indicated month or operating hour interval, whichever comes first.						
Engine Oil (1)	Check Level	○				
	Change		First Oil Change		○	
Engine Oil Filter (1)	Replace					○
Air Pre Cleaner (1)	Clean			○		
Air Cleaner Element (1)	Clean				○	
Spark Plug	Clean adjust				○	
Spark Arrestor (Optional Part)	Clean				○	
Fuel Filter	Check Visually				○	
Fuel Line	Check (Replace if necessary)	Every 2 Years				

- (1) Service more frequently when used in dusty areas and or at high ambient temperatures.

CHANGING THE ENGINE OIL

Drain the oil while the engine is warm to assure rapid and complete draining.

1. Remove the oil filler cap and drain cap, and drain the oil into a suitable container.
2. Retighten the drain cap securely.
3. Refill to the upper limit mark on the dipstick with the recommended oil. Tighten the oil filler cap securely.

TABLE D.4
ENGINE OIL REFILL CAPACITIES

	Honda	Kohler
Without oil filter replacement:	1.27 US qt. (1.06 Imp qt., 1.20 liter)	1.70 US qt (1.41 Imp qt., 1.60 liter)
With oil filter replacement:	1.59 US qt. (1.32 Imp. qt., 1.50 liter)	2.0 US qt. (1.66 Imp qt., 1.90 liter)

Use 4-stroke motor oil that meets or exceeds the requirements for API service classification SG or SH. Always check the API SERVICE label on the oil container to be sure it includes the letters SG or SH.

SAE 10W-30 is recommended for general, all-temperature use, -5% F to 86%F (-20%C to 30%C). See Engine Owner's Manual for more specific information on oil viscosity recommendations.

Wash your hands with soap and water after handling used oil.

Please dispose of used motor oil in a manner that is compatible with the environment. We suggest you take it in a sealed container to your local service station or recycling center for reclamation. Do not throw it in the trash, pour it on the ground or down a drain.

CHANGING THE ENGINE OIL FILTER

1. Drain the engine oil, and retighten the drain cap securely.
2. Remove the oil filter, and drain the oil into a suitable container. Discard the used oil filter.
3. Clean the filter mounting base, and coat the gasket of the new oil filter with clean engine oil.
4. Screw on the new oil filter by hand, until the gasket contacts the filter mounting base, then use an oil filter socket tool to tighten the filter an additional 1/2 to 7/8 turn. See Table D.5 for tightening torque specifications.

TABLE D.5
OIL FILTER TIGHTENING TORQUES

	Honda	Kohler
OIL FILTER TORQUE:	16 ft-lb, (22 Nβm)	10 ft-lb, (13.6Nβm)

5. Refill the crankcase with the specified amount of the recommended oil. Reinstall the oil filler cap.
6. Start the engine and check for oil filter leaks.
7. Stop the engine, and check the oil level. If necessary, add oil to the upper limit mark on the dipstick.

AIR CLEANER SERVICE

A dirty air cleaner will restrict air flow to the carburetor. To prevent carburetor malfunction, service the air cleaner regularly. Service more frequently when operating the engine in extremely dusty areas.

WARNING

- Never use gasoline or low flash point solvents for cleaning the air cleaner element. A fire or explosion could result.
- Never run the engine without the air cleaner. Rapid engine wear will result from contaminants, such as dust and dirt being drawn into the engine.

HONDA ENGINE

1. Remove the wing bolt and remove the air cleaner cover.
2. Remove the two 5 mm Phillips head screws from the air cleaner cover and remove the paper element from the cover. Remove the foam element from the air cleaner body.
3. Foam element: Clean in warm, soapy water, rinse and dry thoroughly.
4. Paper element: Tap the element lightly several times on a hard surface to remove excess dirt, or blow compressed (not exceeding 2.1 kg/cm² (30 psi) air through the filter from the air cleaner cover side. Never try to brush the dirt off; brushing will force dirt into the fibers. Replace the paper element if it is excessively dirty. Replace the paper element and both gaskets.
5. Reinstall the air cleaner elements. Tighten the wing bolt securely.

KOHLER ENGINE**Air Precleaner Service**

1. Loosen the cover retaining knob and remove the cover.
2. Remove the precleaner from the paper element.
3. Wash the precleaner in warm water with detergent. Rinse the precleaner thoroughly until all traces of detergent are eliminated. Squeeze out excess water (do not wring). Allow the precleaner to air dry.
4. Saturate the precleaner with new engine oil. Squeeze out all excess oil.
5. Reinstall the precleaner over the paper element.
6. Reinstall the air cleaner cover. Secure cover with the cover retaining knob.

Air Filter Paper Element Service

1. Loosen the cover retaining knob and remove the cover.
2. Remove the precleaner from the paper element.
3. Remove the element cover nut, element cover, and paper element.
4. Do not wash the paper element or use pressurized air, as this will damage the element. Replace a dirty, bent, or damaged element with a new element. Handle new elements carefully; do not use if the sealing surfaces are bent or damaged.
5. When servicing the air cleaner, check the air cleaner base. Make sure it is secured and not bent or damaged. Also check the element cover for damage or improper fit. Replace all damaged air cleaner components.

NOTE: Before air cleaner reassembly make sure rubber seal is in position around stud. Inspect, making sure it is not damaged and seals with the element cover.

6. Reinstall the paper element, precleaner, element cover, element cover nut, and air cleaner cover. Secure cover with the cover retaining knob.

SPARK PLUG SERVICE

To ensure proper engine operation, the spark plugs must be properly gapped and free of deposits.

1. Remove the spark plug caps.
2. Clean any dirt from around the spark plug bases.
3. Use a plug wrench to remove the spark plugs.

⚠ WARNING

The muffler becomes very hot during operation and remains hot for a while after stopping the engine. Be careful not to touch the muffler while it is hot.

4. Visually inspect the spark plugs. Discard them if the insulator is cracked or chipped. Clean the spark plugs with a wire brush if they are to be reused.
5. Measure the plug gap with a feeler gauge. Correct as necessary by bending the side electrode.
6. Check that the spark plug washer is in good condition and thread the spark plug in by hand to prevent cross-threading.
7. After the spark plug is seated, tighten with a spark plug wrench to compress the washer.
 - If installing a new spark plug, tighten 1/2 turn after the spark plug seats to compress the washer.
 - If reinstalling a used spark plug, tighten 1/8 - 1/4 turn after the spark plug seats to compress the washer.

TABLE D.6
SPARK PLUG INSTALLATION SPECIFICATIONS

	Honda	Kohler
Spark Plug Gap	.030 in. (.76 mm)	.030 in. (.76 mm)
Spark Plug Torque	13.0 ft. lb. (18 N-m)	20 ft. lb. (27 N-m)

⚠ CAUTION

The spark plug must be securely tightened. An improperly tightened spark plug can become very hot and may cause engine damage.

Use only the recommended spark plug or equivalent. A spark plug which has an improper heat range may cause engine damage.

FUEL FILTER SERVICE

⚠ WARNING

When working on the fuel system



- Keep naked lights away, do not smoke !
- Do not spill fuel !

1. Check the fuel filter for water accumulation or sediment.
2. Replace the fuel filter if it is found with excessive water accumulation or sediment.

ENGINE ADJUSTMENTS

⚠ WARNING

OVERSPEED IS HAZARDOUS

The maximum allowable high idle speed for this machine is 3750 RPM, no load. Do NOT tamper with governor components or setting or make any other adjustments to increase the maximum speed. Severe personal injury and damage to the machine can result if operated at speeds above maximum.

Adjustments to the engine are to be made only by a Lincoln Service Center or an authorized Field Service Shop.

BATTERY MAINTENANCE

⚠ WARNING



GASES FROM BATTERY can explode.

- Keep sparks, flame and cigarettes away from battery.

To prevent **EXPLOSION** when:

- **INSTALLING A NEW BATTERY** — disconnect negative cable from old battery first and connect to new battery last.
- **CONNECTING A BATTERY CHARGER** — remove battery from welder by disconnecting negative cable first, then positive cable and battery clamp. When reinstalling, connect negative cable last. Keep well ventilated.
- **USING A BOOSTER** — connect positive lead to battery first then connect negative lead to negative battery lead at engine foot.

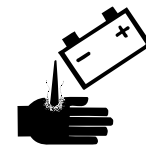

BATTERY ACID can burn eyes and skin.

- Wear gloves and eye protection and be careful when working near battery.
- Follow instructions printed on battery.

To prevent **ELECTRICAL DAMAGE** when:

- a) Installing a battery.
- b) Using a booster.

Use correct polarity - **Negative Ground**.

To prevent **BATTERY DISCHARGE**, if you have an ignition switch, turn it off when engine is not running.

The battery is a group 58, with a rating of 435 cold cranking amps.

CLEANING THE BATTERY

Keep the battery clean by wiping it with a damp cloth when dirty. If the terminals appear corroded, disconnect the battery cables and wash the terminals with an ammonia solution or a solution of 1/4 pound (0.1113 kg) of baking soda and 1 quart (0.946 L) of water. Be sure the battery vent plugs (if equipped) are tight so that none of the solution enters the cells.

After cleaning, flush the outside of the battery, the battery compartment, and surrounding areas with clear water. Coat the battery terminals lightly with petroleum jelly or a non-conductive grease to retard corrosion.

Keep the battery clean and dry. Moisture accumulation on the battery can lead to more rapid discharge and early battery failure.

CHECKING ELECTROLYTE LEVEL

If battery cells are low, fill them to the neck of the filler hole with distilled water and recharge. If one cell is low, check for leaks.

CHARGING THE BATTERY

When you charge, jump, replace, or otherwise connect battery cables to the battery, be sure the polarity is correct. Improper polarity can damage the charging circuit. The GX-271 positive (+) battery terminal has a red terminal cover.

If you need to charge the battery with an external charger, disconnect the negative cable first, then the positive cable before you attach the charger leads. After the battery is charged, reconnect the positive battery cable first and the negative cable last. Failure to do so can result in damage to the internal charger components.

Follow the instructions of the battery charger manufacturer for proper charger settings and charging time.

SERVICING OPTIONAL SPARK ARRESTOR

WARNING



- MUFFLER MAY BE HOT!
- ALLOW ENGINE TO COOL BEFORE INSTALLING THE SPARK ARRESTOR!

• DO NOT OPERATE ENGINE WHILE INSTALLING THE SPARK ARRESTOR!

1. Service every 100 hours.
2. Shut off engine and allow muffler to cool.
3. Remove clean out plug on bottom of spark arrestor.

4. Lightly tap on arrestor around drain hole to remove particulate.
5. It may be necessary to poke around inside drain hole with a wire or screwdriver to break up particulate.
6. Reinstall clean out plug.

WELDER / GENERATOR MAINTENANCE

STORAGE

Store the GX-271 in clean, dry protected areas.

CLEANING

Blow out the generator and controls periodically with low pressure air. Do this at least once a week in particularly dirty areas.

BRUSH REMOVAL AND REPLACEMENT

It is normal for the brushes and slip rings to wear and darken slightly. Inspect the brushes when a generator overhaul is necessary.

WARNING

Do not attempt to polish slip rings while the engine is running.

HOW TO USE TROUBLESHOOTING GUIDE

⚠ WARNING

Service and Repair should only be performed by Lincoln Electric Factory Trained Personnel. Unauthorized repairs performed on this equipment may result in danger to the technician and machine operator and will invalidate your factory warranty. For your safety and to avoid Electrical Shock, please observe all safety notes and precautions detailed throughout this manual.

This Troubleshooting Guide is provided to help you locate and repair possible machine malfunctions. Simply follow the three-step procedure listed below.

Step 1. LOCATE PROBLEM (SYMPTOM).

Look under the column labeled "PROBLEM (SYMPTOMS)". This column describes possible symptoms that the machine may exhibit. Find the listing that best describes the symptom that the machine is exhibiting. Symptoms are grouped into the following categories: engine problems, function problems and output problems.

Step 2. PERFORM EXTERNAL TESTS.

The second column labeled "POSSIBLE AREAS OF MISADJUSTMENT(S)" lists the obvious external possibilities that may contribute to the machine symptom. Perform these tests/checks in the order listed. In general, these tests can be conducted without removing the case wrap-around cover.

Step 3. RECOMMENDED COURSE OF ACTION

If you have exhausted all of the items in step 2. Contact your Local Lincoln Authorized Field Service Facility.

⚠ WARNING



ELECTRIC SHOCK can kill.

- Do not touch electrically live parts such as output terminals or internal wiring.



ENGINE EXHAUST can kill.

- Use in open, well ventilated areas or vent exhaust outside.



MOVING PARTS can injure.

- Do not operate with doors open or guards off.
- Stop engine before servicing.
- Keep away from moving parts.
- Remove guards only when necessary and replace when work requiring removal is complete.
- Only qualified personnel should install, use or service this equipment.

⚠ CAUTION

If for any reason you do not understand the test procedures or are unable to perform the tests/repairs safely, contact your **Local Lincoln Authorized Field Service Facility** for technical troubleshooting assistance before you proceed.

Observe all Safety Guidelines detailed throughout this manual

PROBLEMS (SYMPTOMS)	POSSIBLE AREAS OF MISADJUSTMENTS(S)	RECOMMENDED COURSE OF ACTION
Major Physical or Electrical Damage is Evident.		1. Contact your Local Lincoln Authorized Field Service Facility.
Engine will not "crank".	<ol style="list-style-type: none"> 1. Battery is low. 2. Loose battery cable connections. 3. Faulty engine starter motor. 4. "Battery Circuit" circuit breaker is tripped. 	<ol style="list-style-type: none"> 1. Charge Battery. 2. Inspect, clean and tighten. 3. Contact authorized engine Service Shop. 4. Re-set. If it continues to trip, contact your local Local Lincoln Authorized Field Service Facility.
Engine will "crank" but not start.	<ol style="list-style-type: none"> 1. Out of fuel. 2. Engine switch in "OFF" position. 3. Faulty fuel solenoid or faulty PC board or ignition system. 	<ol style="list-style-type: none"> 1. Fill tank and start engine. 2. Set switch to "ON" position. 3. Contact your Local Lincoln Authorized Field Service Facility or authorized engine service shop.
Engine shuts down shortly after starting.	<ol style="list-style-type: none"> 1. Low oil level. 2. Faulty oil pressure switch or other engine component. 	<ol style="list-style-type: none"> 1. Change oil and oil filter and fill to proper level. Start engine and look for leaks. 2. Contact your Local Lincoln Authorized Field Service Facility or authorized engine service shop.
Battery does not stay charged.	<ol style="list-style-type: none"> 1. Faulty battery. 2. Loose connections at battery or alternator. 3. Faulty engine alternator or charger module. 	<ol style="list-style-type: none"> 1. Replace 2. Clean and tighten connections. 3. Consult authorized engine service shop.

⚠ CAUTION

If for any reason you do not understand the test procedures or are unable to perform the tests/repairs safely, contact your **Local Lincoln Authorized Field Service Facility** for technical troubleshooting assistance before you proceed.

Observe all Safety Guidelines detailed throughout this manual

PROBLEMS (SYMPTOMS)	POSSIBLE AREAS OF MISADJUSTMENTS(S)	RECOMMENDED COURSE OF ACTION
Engine will not idle down to low speed.	<ol style="list-style-type: none"> 1. Idler switch in High idle position. 2. External load on welder or auxiliary power. 3. Faulty PC board or idler solenoid. 	<ol style="list-style-type: none"> 1. Set switch to Auto. 2. Remove all external loads. 3. Contact your Local Lincoln Authorized Field Service Facility for technical troubleshooting assistance.
Engine will not go to high idle when attempting to weld.	<ol style="list-style-type: none"> 1. Poor work lead connection to work. 2. "Welding Terminals" switch is in wrong position. 3. Faulty PC board. Low idle speed set too low. 	<ol style="list-style-type: none"> 1. Make sure work clamp is tightly connected to clean base metal. 2. Set to "Always On" when welding without a welding terminal control cable. Refer to Operations chapter for proper use of this switch. 3. Contact your Local Lincoln Authorized Field Service Facility for technical troubleshooting assistance.
Engine will not go to high idle when using auxiliary power.	<ol style="list-style-type: none"> 1. Auxiliary power load is less than 100 watts. 2. Faulty PC board. 	<ol style="list-style-type: none"> 1. Idler may not respond with less than a 100 watt load. Set idler to "High". 2. Contact your Local Lincoln Authorized Field Service Facility for technical troubleshooting assistance.
Engine does not develop full power.	<ol style="list-style-type: none"> 1. Fuel filter clogged. 2. Air filter clogged. 3. Fouled spark plugs. 4. Valves out of adjustment. 	<ol style="list-style-type: none"> 1. Replace. 2. Clean or replace. 3. Clean or replace. 4. Contact authorized engine service shop.

 **CAUTION**

If for any reason you do not understand the test procedures or are unable to perform the tests/repairs safely, contact your **Local Lincoln Authorized Field Service Facility** for technical troubleshooting assistance before you proceed.

Observe all Safety Guidelines detailed throughout this manual

PROBLEMS (SYMPTOMS)	POSSIBLE AREAS OF MISADJUSTMENTS(S)	RECOMMENDED COURSE OF ACTION
No welding power output.	<ol style="list-style-type: none"> 1. "Welding Terminals" switch in wrong position. 2. Faulty welding alternator or faulty PC board. 	<ol style="list-style-type: none"> 1. Place switch in "Always On" position when welding without welding terminal control cable. Refer to Operation chapter for proper switch function. 2. Contact your Local Lincoln Authorized Field Service Facility for technical troubleshooting assistance.
Welder has output but no control.	<ol style="list-style-type: none"> 1. "Local/Remote" switch is in wrong position. 2. Poor remote kit connection. 3. Faulty remote kit. 4. Faulty control potentiometer or faulty PC board. 	<ol style="list-style-type: none"> 1. Place switch in "Control at Welder" position to control output at welder. Place switch in "Remote" position to control output remotely. Refer to Operation chapter for proper switch function. 2. Check connections. 3. Replace if necessary. 4. Contact your Local Lincoln Authorized Field Service Facility for technical troubleshooting assistance.
No auxiliary power.	<ol style="list-style-type: none"> 1. Open circuit breakers. 2. Faulty connections to auxiliary receptacles. 3. GFCI tripped. 4. Faulty welding alternator or faulty PC board. 	<ol style="list-style-type: none"> 1. Reset breakers. If breakers keep tripping, reduce power draw. 2. Check connections. 3. Clear any ground fault and reset GFCI circuit by pressing "Reset" button on the 120 V receptacle. 4. Contact your Local Lincoln Authorized Field Service Facility for technical troubleshooting assistance.
Wire feeder does not work when connected to welder 14 pin amphe-nol.	<ol style="list-style-type: none"> 1. Wire Feeder Power circuit breaker open. 2. Faulty wiring in control cable 3. Faulty wire feeder. 	<ol style="list-style-type: none"> 1. Reset 2. Repair or replace cable 3. Replace with known good one.

⚠ CAUTION

If for any reason you do not understand the test procedures or are unable to perform the tests/repairs safely, contact your **Local Lincoln Authorized Field Service Facility** for technical troubleshooting assistance before you proceed.

WIRING DIAGRAM

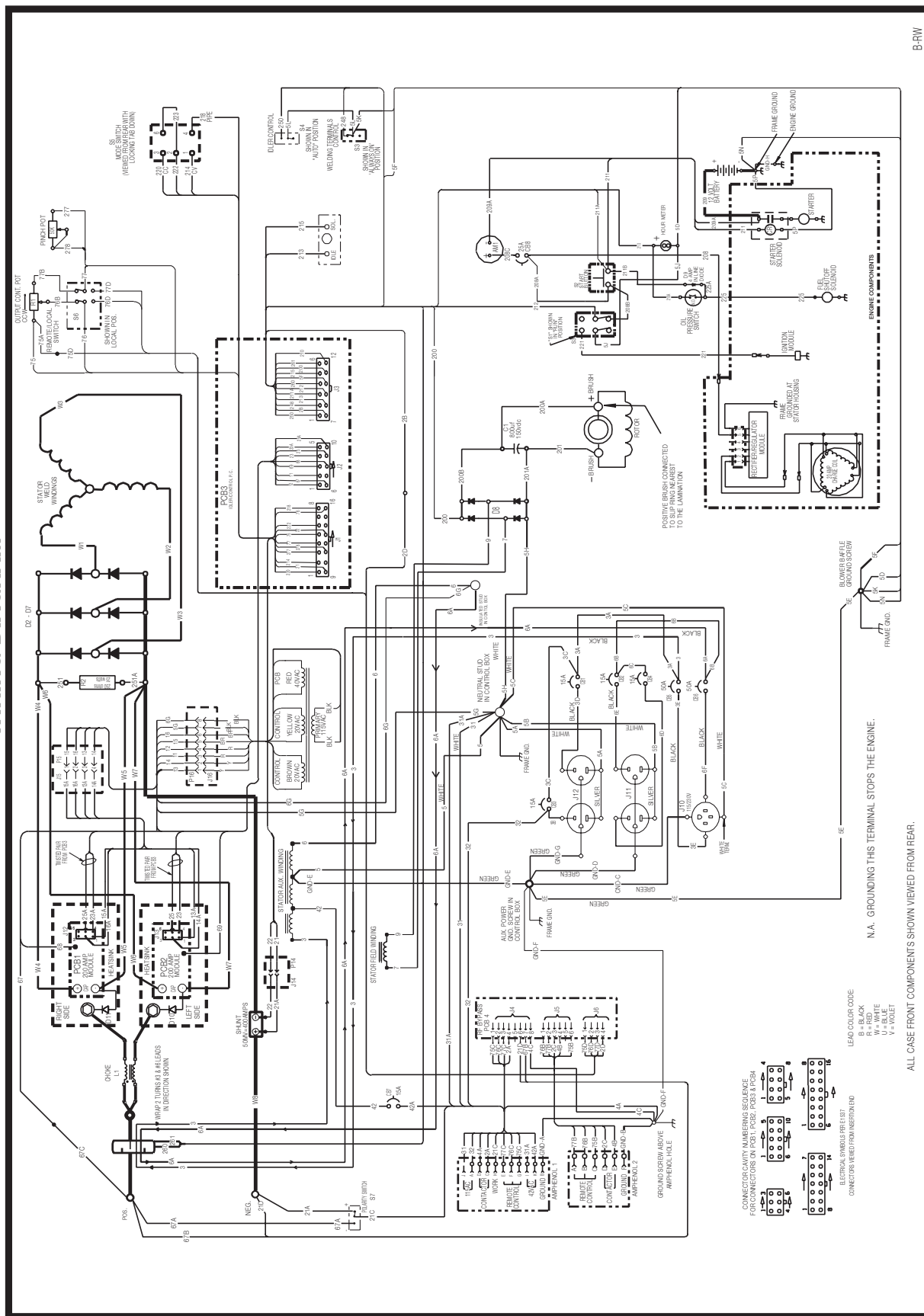

B-RW
L10791

NOTE: This diagram is for reference only. It may not be accurate for all machines covered by this manual. The specific diagram for a particular code is pasted inside the machine on one of the enclosure panels. If the diagram is illegible, write to the Service Department for a replacement. Give the equipment code number.

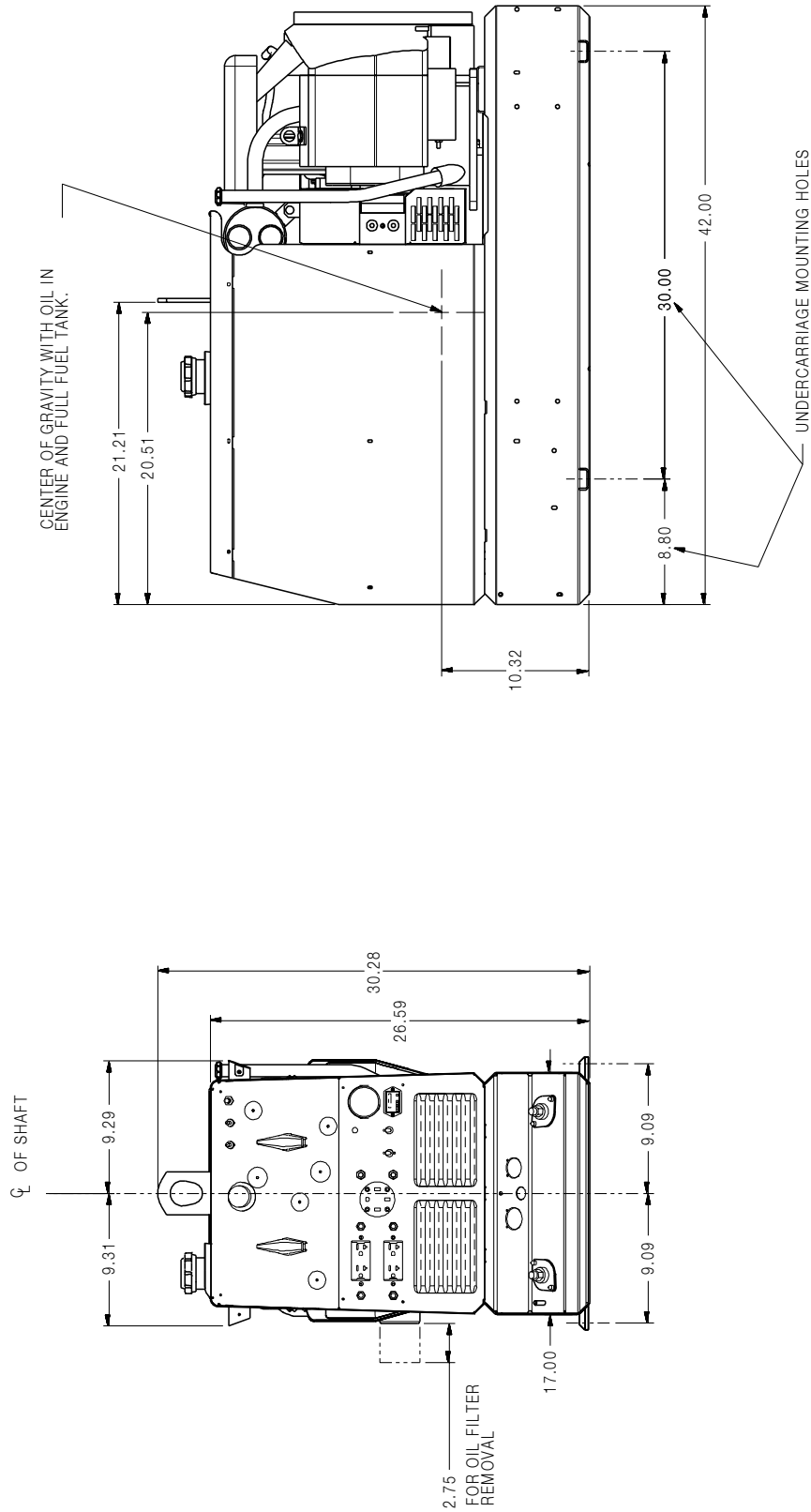

12-16-93
M17216

WARNING	<ul style="list-style-type: none"> ● Do not touch electrically live parts or electrode with skin or wet clothing. ● Insulate yourself from work and ground. 	<ul style="list-style-type: none"> ● Keep flammable materials away. 	<ul style="list-style-type: none"> ● Wear eye, ear and body protection.
Spanish AVISO DE PRECAUCION	<ul style="list-style-type: none"> ● No toque las partes o los electrodos bajo carga con la piel o ropa mojada. ● Aislese del trabajo y de la tierra. 	<ul style="list-style-type: none"> ● Mantenga el material combustible fuera del área de trabajo. 	<ul style="list-style-type: none"> ● Protéjase los ojos, los oídos y el cuerpo.
French ATTENTION	<ul style="list-style-type: none"> ● Ne laissez ni la peau ni des vêtements mouillés entrer en contact avec des pièces sous tension. ● Isolez-vous du travail et de la terre. 	<ul style="list-style-type: none"> ● Gardez à l'écart de tout matériel inflammable. 	<ul style="list-style-type: none"> ● Protégez vos yeux, vos oreilles et votre corps.
German WARNUNG	<ul style="list-style-type: none"> ● Berühren Sie keine stromführenden Teile oder Elektroden mit Ihrem Körper oder feuchter Kleidung! ● Isolieren Sie sich von den Elektroden und dem Erdboden! 	<ul style="list-style-type: none"> ● Entfernen Sie brennbares Material! 	<ul style="list-style-type: none"> ● Tragen Sie Augen-, Ohren- und Körperschutz!
Portuguese ATENÇÃO	<ul style="list-style-type: none"> ● Não toque partes elétricas e electrodos com a pele ou roupa molhada. ● Isole-se da peça e terra. 	<ul style="list-style-type: none"> ● Mantenha inflamáveis bem guardados. 	<ul style="list-style-type: none"> ● Use proteção para a vista, ouvido e corpo.
Japanese 注意事項	<ul style="list-style-type: none"> ● 通電中の電気部品、又は溶材にヒフやぬれた布で触れないこと。 ● 施工物やアースから身体が絶縁されている様にして下さい。 	<ul style="list-style-type: none"> ● 燃えやすいものの側での溶接作業は絶対にしてはなりません。 	<ul style="list-style-type: none"> ● 目、耳及び身体に保護具をして下さい。
Chinese 警告	<ul style="list-style-type: none"> ● 皮膚或濕衣物切勿接觸帶電部件及鎢條。 ● 使你自已與地面和工件絕緣。 	<ul style="list-style-type: none"> ● 把一切易燃物品移離工作場所。 	<ul style="list-style-type: none"> ● 佩戴眼、耳及身體勞動保護用具。
Korean 위험	<ul style="list-style-type: none"> ● 전도체나 용접봉을 젖은 헝겍 또는 피부로 절대 접촉치 마십시오. ● 모재와 접지를 접촉치 마십시오. 	<ul style="list-style-type: none"> ● 인화성 물질을 접근시키지 마십시오. 	<ul style="list-style-type: none"> ● 눈, 귀와 몸에 보호장구를 착용하십시오.
Arabic تحذير	<ul style="list-style-type: none"> ● لا تلمس الاجزاء التي يسري فيها التيار الكهربائي أو الألكترود بجسدك أو بالملابس المبللة بالماء. ● ضع عازلا على جسمك خلال العمل. 	<ul style="list-style-type: none"> ● ضع المواد القابلة للاشتعال في مكان بعيد. 	<ul style="list-style-type: none"> ● ضع أدوات وملابس واقية على عينيك وأذنيك وجسمك.

READ AND UNDERSTAND THE MANUFACTURER'S INSTRUCTION FOR THIS EQUIPMENT AND THE CONSUMABLES TO BE USED AND FOLLOW YOUR EMPLOYER'S SAFETY PRACTICES.

SE RECOMIENDA LEER Y ENTENDER LAS INSTRUCCIONES DEL FABRICANTE PARA EL USO DE ESTE EQUIPO Y LOS CONSUMIBLES QUE VA A UTILIZAR, SIGA LAS MEDIDAS DE SEGURIDAD DE SU SUPERVISOR.

LISEZ ET COMPRENEZ LES INSTRUCTIONS DU FABRICANT EN CE QUI REGARDE CET EQUIPMENT ET LES PRODUITS A ETRE EMPLOYES ET SUIVEZ LES PROCEDURES DE SECURITE DE VOTRE EMPLOYEUR.

LESEN SIE UND BEFOLGEN SIE DIE BETRIEBSANLEITUNG DER ANLAGE UND DEN ELEKTRODENEINSATZ DES HERSTELLERS. DIE UNFALLVERHÜTUNGSVORSCHRIFTEN DES ARBEITGEBERS SIND EBENFALLS ZU BEACHTEN.

			
<ul style="list-style-type: none"> ● Keep your head out of fumes. ● Use ventilation or exhaust to remove fumes from breathing zone. 	<ul style="list-style-type: none"> ● Turn power off before servicing. 	<ul style="list-style-type: none"> ● Do not operate with panel open or guards off. 	WARNING
<ul style="list-style-type: none"> ● Los humos fuera de la zona de respiración. ● Mantenga la cabeza fuera de los humos. Utilice ventilación o aspiración para gases. 	<ul style="list-style-type: none"> ● Desconectar el cable de alimentación de poder de la máquina antes de iniciar cualquier servicio. 	<ul style="list-style-type: none"> ● No operar con panel abierto o guardas quitadas. 	Spanish AVISO DE PRECAUCION
<ul style="list-style-type: none"> ● Gardez la tête à l'écart des fumées. ● Utilisez un ventilateur ou un aspirateur pour ôter les fumées des zones de travail. 	<ul style="list-style-type: none"> ● Débranchez le courant avant l'entretien. 	<ul style="list-style-type: none"> ● N'opérez pas avec les panneaux ouverts ou avec les dispositifs de protection enlevés. 	French ATTENTION
<ul style="list-style-type: none"> ● Vermeiden Sie das Einatmen von Schweißrauch! ● Sorgen Sie für gute Be- und Entlüftung des Arbeitsplatzes! 	<ul style="list-style-type: none"> ● Strom vor Wartungsarbeiten abschalten! (Netzstrom völlig öffnen; Maschine anhalten!) 	<ul style="list-style-type: none"> ● Anlage nie ohne Schutzgehäuse oder Innenschutzverkleidung in Betrieb setzen! 	German WARNUNG
<ul style="list-style-type: none"> ● Mantenha seu rosto da fumaça. ● Use ventilação e exaustão para remover fumo da zona respiratória. 	<ul style="list-style-type: none"> ● Não opere com as tampas removidas. ● Desligue a corrente antes de fazer serviço. ● Não toque as partes elétricas nuas. 	<ul style="list-style-type: none"> ● Mantenha-se afastado das partes moventes. ● Não opere com os painéis abertos ou guardas removidas. 	Portuguese ATENÇÃO
<ul style="list-style-type: none"> ● ヒュームから頭を離すようにして下さい。 ● 換気や排煙に十分留意して下さい。 	<ul style="list-style-type: none"> ● メンテナンス・サービスに取りかかる際には、まず電源スイッチを必ず切ってください。 	<ul style="list-style-type: none"> ● パネルやカバーを取り外したまま機械操作をしないで下さい。 	Japanese 注意事項
<ul style="list-style-type: none"> ● 頭部遠離煙霧。 ● 在呼吸區使用通風或排風器除煙。 	<ul style="list-style-type: none"> ● 維修前切斷電源。 	<ul style="list-style-type: none"> ● 儀表板打開或沒有安全罩時不準作業。 	Chinese 警告
<ul style="list-style-type: none"> ● 얼굴로부터 용접가스를 멀리하십시오. ● 호흡지역으로부터 용접가스를 제거하기 위해 가스제거기나 통풍기를 사용하십시오. 	<ul style="list-style-type: none"> ● 보수전에 전원을 차단하십시오. 	<ul style="list-style-type: none"> ● 판넬이 열린 상태로 작동치 마십시오. 	Korean 위험
<ul style="list-style-type: none"> ● ابعء رأسك بعيداً عن الدخان. ● استعمل التهوية أو جهاز ضغط الدخان للخارج لكي تبعد الدخان عن المنطقة التي تتنفس فيها. 	<ul style="list-style-type: none"> ● أقطع التيار الكهربائي قبل القيام بأية صيانة. 	<ul style="list-style-type: none"> ● لا تشغيل هذا الجهاز اذا كانت الاغطية الحديدية الواقية ليست عليه. 	Arabic تحذير

LEIA E COMPREENDA AS INSTRUÇÕES DO FABRICANTE PARA ESTE EQUIPAMENTO E AS PARTES DE USO, E SIGA AS PRÁTICAS DE SEGURANÇA DO EMPREGADOR.

使う機械や溶材のメーカーの指示書をよく読み、まず理解して下さい。そして貴社の安全規定に従って下さい。

請詳細閱讀並理解製造廠提供的說明以及應該使用的銀焊材料，並請遵守貴方的有閣勞動保護規定。

이 제품에 동봉된 작업지침서를 숙지하시고 귀사의 작업자 안전수칙을 준수하시기 바랍니다.

اقرأ بتمعن وافهم تعليمات المصنع المنتج لهذه المعدات والمواد قبل استعمالها واتبع تعليمات الوقاية لصاحب العمل.