



OM-279640N

2023-05

Processes



Multiprocess Welding

Description



Engine Driven Welder/Generator And Air Compressor

Big Blue[®] 600 Air Pak[®], Big Blue[®] 800 Duo Pro And Duo Air Pak

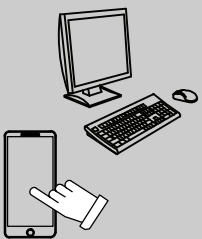
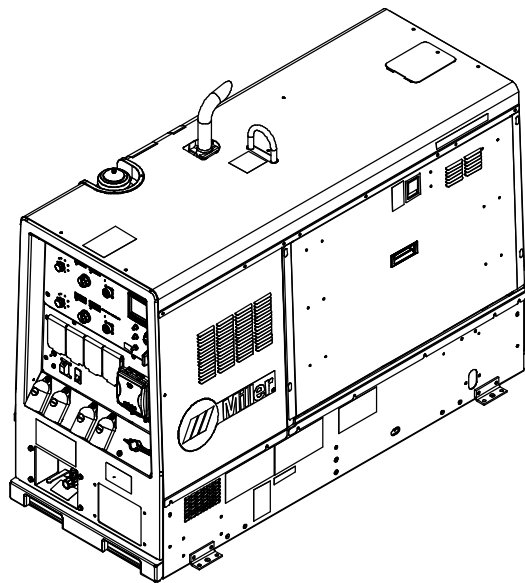

For product information,
Owner's Manual translations,
and more, visit

www.MillerWelds.com

OWNER'S MANUAL

From Miller to You

Thank you and congratulations on choosing Miller. Now you can get the job done and get it done right. We know you don't have time to do it any other way.

That's why when Niels Miller first started building arc welders in 1929, he made sure his products offered long-lasting value and superior quality. Like you, his customers couldn't afford anything less. Miller products had to be more than the best they could be. They had to be the best you could buy.

Today, the people that build and sell Miller products continue the tradition. They're just as committed to providing equipment and service that meets the high standards of quality and value established in 1929.

This Owner's Manual is designed to help you get the most out of your Miller products. Please take time to read the Safety Precautions. They will help you protect yourself against potential hazards on the worksite. We've made installation and operation quick and easy. With Miller, you can count on years of reliable service with proper maintenance. And if for some reason the unit needs repair, there's a Troubleshooting section that will help you figure out what the problem is, and our extensive service network is there to help fix the problem. Warranty and maintenance information for your particular model are also provided.

Miller Electric manufactures a full line of welders and welding-related equipment. For information on other quality Miller products, contact your local Miller distributor to receive the latest full line catalog or individual specification sheets. **To locate your nearest distributor or service agency call**

1-800-4-A-Miller, or visit us at www.MillerWelds.com on the web.



Working as hard as you do – every power source from Miller is backed by the most hassle-free warranty in the business.



ISO 9001
Quality

Miller is the first welding equipment manufacturer in the U.S.A. to be registered to the ISO 9001 Quality System Standard.



TABLE OF CONTENTS

SECTION 1 – SAFETY PRECAUTIONS – READ BEFORE USING	1
1-1 Symbol Usage	1
1-2 Arc Welding Hazards	1
1-3 Engine Hazards	3
1-4 Compressed Air Hazards	4
1-5 Additional Hazards For Installation, Operation, And Maintenance	4
1-6 California Proposition 65 Warnings	6
1-7 Principal Safety Standards	6
1-8 EMF Information	6
SECTION 2 – CONSIGNES DE SÉCURITÉ - LIRE AVANT UTILISATION	7
2-1 Symboles utilisés	7
2-2 Dangers relatifs au soudage à l'arc	7
2-3 Dangers existant en relation avec le moteur	9
2-4 Dangers liés à l'air comprimé	10
2-5 Symboles de dangers supplémentaires en relation avec l'installation, le fonctionnement et la maintenance	11
2-6 Proposition californienne 65 Avertissements	13
2-7 Principales normes de sécurité	13
2-8 Informations relatives aux CEM	13
SECTION 3 – DEFINITIONS	15
3-1 Additional Safety Symbol Definitions	15
3-2 Miscellaneous Symbols And Definitions	18
SECTION 4 – SPECIFICATIONS	20
4-1 Serial Number And Rating Label Location	20
4-2 Software Licensing Agreement	20
4-3 Information About Default Weld Parameters And Settings	20
4-4 Weld, Power, And Engine Specifications	20
4-5 Air Compressor Specifications (Air Pak Models)	20
4-6 Environmental Specifications	20
4-7 Dimensions, Weights, And Operating Angles	21
4-8 Duty Cycle And Overheating	21
4-9 Volt-Ampere Curves (800 Models)	22
4-10 Volt-Ampere Curves (600 Models)	23
4-11 Generator Power Curves	24
4-12 Fuel Consumption	25
SECTION 5 – INSTALLATION	26
5-1 Installing Welder/Generator	26
5-2 Grounding Generator to Truck or Trailer Frame	27
5-3 Installing Exhaust Pipe	27
5-4 Connecting The Battery	28
5-5 Using The Battery Disconnect Switch	28
5-6 Engine Prestart Checks	29
5-7 Selecting Cable Sizes*	30
5-8 Weld Output Terminals	30
5-9 Connecting Weld Output Cables	31
5-10 Connecting To Remote Receptacle	31
5-11 Making Dual Operator CC Weld Connections With Separate Work Cables (800 Models)	32
5-12 Making Dual Operator CC Weld Connections With Common Work Cable (800 Models)	33
5-13 Making Dual Operator CV Weld Connections With Separate Work Cables (800 Models)	34
5-14 Making Dual Operator CV Weld Connections With Common Work Cable (800 Models)	35

⚠ WARNING – Breathing diesel engine exhaust exposes you to chemicals known to the State of California to cause cancer and birth defects or other reproductive harm.

- Always start and operate the engine in a well-ventilated area.
- If in an enclosed area, vent the exhaust to the outside.
- Do not modify or tamper with the exhaust system.
- Do not idle the engine except as necessary.

For more information go to www.P65warnings.ca.gov/diesel.

TABLE OF CONTENTS

5-15	Making Dual Operator CC And CV Weld Connections With Separate Work Cables (800 Models)	36
5-16	Making Dual Operator CC And CV Weld Connections With Common Work Cable (800 Models)	37
5-17	Making Single Operator CC Weld Connections (800 Models)	38
5-18	Connecting To The Air Compressor (Air Pak Models)	39
SECTION 6 – OPERATION		40
6-1	Front Panel Controls	40
6-2	Description Of Front Panel Controls (See Section 6-1)	41
6-3	Engine Starting Sequence	42
6-4	Process/Contactor Switch	42
6-5	Service Menu	43
6-6	Arc Control Settings	44
6-7	Dynamic Dig Settings	45
6-8	Stick Start Procedure—Scratch Start Technique	45
6-9	Lift-Arc™ TIG With Auto-Stop™ And Auto-Crater™	46
6-10	Remote Voltage/Amperage Control	47
6-11	Operating Engine Block Heater	48
6-12	Updating Software	49
6-13	Summary File	50
6-14	Fuel/Hour Gauge Descriptions	51
6-15	Associating ArcReach® Devices (ArcReach Models Only)	52
6-16	Optional Air Dryer Operation (Air Pak Models)	53
SECTION 7 – OPERATING AUXILIARY EQUIPMENT		54
7-1	Generator Power Receptacles	54
7-2	GFCI Receptacle Information, Resetting, And Testing	55
SECTION 8 – MAINTENANCE		56
8-1	Maintenance Label	56
8-2	Cleaning Unit	57
8-3	Routine Maintenance	57
8-4	Checking Generator Brushes	58
8-5	Battery Replacement	59
8-6	Battery Maintenance	59
8-7	Servicing Air Cleaner	60
8-8	Engine Speed Adjustment	60
8-9	Oil Specifications	61
8-10	Servicing Fuel And Lubrication Systems	62
8-11	Engine/Generator Overload Protection	63
8-12	Voltmeter/Ammeter Error Displays	64
8-13	Removing Optional Air Dryer For Service	65
SECTION 9 – AIR COMPRESSOR MAINTENANCE (AIR PAK MODELS)		66
9-1	Air Compressor Maintenance Label	66
9-2	Routine Air Compressor Maintenance	67
9-3	Servicing Air Cleaner	68
9-4	Compressor Overload Protection	69
9-5	Servicing Air Compressor	70
9-6	Adjusting Compressor Air Pressure	71
SECTION 10 – TROUBLESHOOTING		72
10-1	Troubleshooting	72
SECTION 11 – PARTS LIST		75
11-1	Recommended Spare Parts	75
SECTION 12 – ELECTRICAL DIAGRAMS		76
SECTION 13 – ENGINE INFORMATION DISPLAY		88
SECTION 14 – RUN-IN PROCEDURE		101
14-1	Wetstacking	101
14-2	Run-In Procedure Using Load Bank Or Resistance Grid	102
SECTION 15 – AIR COMPRESSOR TABLES		103
SECTION 16 – GENERATOR POWER GUIDELINES		105

SECTION 1 – SAFETY PRECAUTIONS – READ BEFORE USING

 Protect yourself and others from injury—read, follow, and save these important safety precautions and operating instructions.

1-1. Symbol Usage

 **DANGER!** – Indicates a hazardous situation which, if not avoided, will result in death or serious injury. The possible hazards are shown in the adjoining symbols or explained in the text.

 Indicates a hazardous situation which, if not avoided, could result in death or serious injury. The possible hazards are shown in the adjoining symbols or explained in the text.

NOTICE – Indicates statements not related to personal injury.

 Indicates special instructions.



This group of symbols means Warning! Watch Out! ELECTRIC SHOCK, MOVING PARTS, and HOT PARTS hazards. Consult symbols and related instructions below for necessary actions to avoid these hazards.

1-2. Arc Welding Hazards

 The symbols shown below are used throughout this manual to call attention to and identify possible hazards. When you see the symbol, watch out, and follow the related instructions to avoid the hazard. The safety information given below is only a summary of the more complete safety information found in the Principal Safety Standards. Read and follow all Safety Standards.

 Only qualified persons should install, operate, maintain, and repair this equipment. A qualified person is defined as one who, by possession of a recognized degree, certificate, or professional standing, or who by extensive knowledge, training and experience, has successfully demonstrated the ability to solve or resolve problems relating to the subject matter, the work, or the project and has received safety training to recognize and avoid the hazards involved.

 During operation, keep everybody, especially children, away.



ELECTRIC SHOCK can kill.

Touching live electrical parts can cause fatal shocks or severe burns. The electrode and work circuit is electrically live whenever the output is on.

The input power circuit and machine internal circuits are also live when power is on. In semiautomatic or automatic wire welding, the wire, wire reel, drive roll housing, and all metal parts touching the welding wire are electrically live. Incorrectly installed or improperly grounded equipment is a hazard.

- Do not touch live electrical parts.
- Wear dry, hole-free insulating gloves and body protection.
- Insulate yourself from work and ground using dry insulating mats or covers big enough to prevent any physical contact with the work or ground.
- Do not use AC weld output in damp, wet, or confined spaces, or if there is a danger of falling.
- Use AC output ONLY if required for the welding process.
- If AC output is required, use remote output control if present on unit.
- Additional safety precautions are required when any of the following electrically hazardous conditions are present: in damp locations or while wearing wet clothing; on metal structures such as floors, gratings, or scaffolds; when in cramped positions such as sitting, kneeling, or lying; or when there is a high risk of unavoidable or accidental contact with the workpiece or ground. For these conditions, use the following equipment in order presented: 1) a semiautomatic DC constant voltage (wire) welder, 2) a DC manual (stick) welder, or 3) an AC welder with reduced open-circuit voltage. In most situations, use of a DC, constant voltage wire welder is recommended. And, do not work alone!
- Do not connect to any electrical distribution system normally supplied by utility power unless a proper transfer switch and grounding procedure are employed.

- Disconnect input power or stop engine before installing or servicing this equipment. Lockout/tagout input power according to OSHA 29 CFR 1910.147 (see Safety Standards).
- Properly install, ground, and operate this equipment according to its Owner's Manual and national, state, and local codes.
- Always verify the supply ground—check and be sure that input power cord ground wire is properly connected to ground terminal in disconnect box or that cord plug is connected to a properly grounded receptacle outlet.
- When making input connections, attach proper grounding conductor first—double-check connections.
- Keep cords dry, free of oil and grease, and protected from hot metal and sparks.
- Frequently inspect input power cord and ground conductor for damage or bare wiring—replace immediately if damaged—bare wiring can kill.
- Turn off all equipment when not in use.
- Do not use worn, damaged, undersized, or repaired cables.
- Do not drape cables over your body.
- If earth grounding of the workpiece is required, ground it directly with a separate cable.
- Do not touch electrode if you are in contact with the work, ground, or another electrode from a different machine.
- Use only well-maintained equipment. Repair or replace damaged parts at once. Maintain unit according to manual.
- Do not touch electrode holders connected to two welding machines at the same time since double open-circuit voltage will be present.
- Wear a safety harness if working above floor level.
- Keep all panels and covers securely in place.
- Clamp work cable with good metal-to-metal contact to workpiece or worktable as near the weld as practical.
- Insulate work clamp when not connected to workpiece to prevent contact with any metal object.
- Do not connect more than one electrode or work cable to any single weld output terminal. Disconnect cable for process not in use.
- Use GFCI protection when operating auxiliary equipment. Test GFCI receptacles at high speed.



HOT PARTS can burn.

- Do not touch hot parts bare handed.
- Allow cooling period before working on equipment.
- To handle hot parts, use proper tools and/or wear heavy, insulated welding gloves and clothing to

prevent burns.

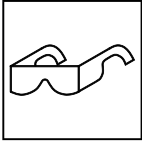

FLYING METAL OR DIRT can injure eyes.

- Welding, chipping, wire brushing, and grinding cause sparks and flying metal. As welds cool, they can throw off slag.
- Wear approved safety glasses with side shields even under your welding helmet.



FUMES AND GASES can be hazardous.

Welding produces fumes and gases. Breathing these fumes and gases can be hazardous to your health.

- Keep your head out of the fumes. Do not breathe the fumes.
- Ventilate the work area and/or use local forced ventilation at the arc to remove welding fumes and gases. The recommended way to determine adequate ventilation is to sample for the composition and quantity of fumes and gases to which personnel are exposed.
- If ventilation is poor, wear an approved air-supplied respirator.
- Read and understand the Safety Data Sheets (SDSs) and the manufacturer's instructions for adhesives, coatings, cleaners, consumables, coolants, degreasers, fluxes, and metals.
- Work in a confined space only if it is well ventilated, or while wearing an air-supplied respirator. Always have a trained watchperson nearby. Welding fumes and gases can displace air and lower the oxygen level causing injury or death. Be sure the breathing air is safe.
- Do not weld in locations near degreasing, cleaning, or spraying operations. The heat and rays of the arc can react with vapors to form highly toxic and irritating gases.
- Do not weld on coated metals, such as galvanized, lead, or cadmium plated steel, unless the coating is removed from the weld area, the area is well ventilated, and while wearing an air-supplied respirator. The coatings and any metals containing these elements can give off toxic fumes if welded.



BUILDUP OF GAS can injure or kill.

- Shut off compressed gas supply when not in use.
- Always ventilate confined spaces or use approved air-supplied respirator.



ARC RAYS can burn eyes and skin.

Arc rays from the welding process produce intense visible and invisible (ultraviolet and infrared) rays that can burn eyes and skin. Sparks fly off from the weld.

- Wear an approved welding helmet fitted with a proper shade of filter lenses to protect your face and eyes from arc rays and sparks when welding or watching (see ANSI Z49.1 and Z87.1 listed in Safety Standards).
- Wear approved safety glasses with side shields under your helmet.
- Use protective screens or barriers to protect others from flash, glare, and sparks; warn others not to watch the arc.
- Wear body protection made from leather or flame-resistant clothing (FRC). Body protection includes oil-free clothing such as leather gloves, heavy shirt, cuffless trousers, high shoes, and a cap.



WELDING can cause fire or explosion.

Welding on closed containers, such as tanks, drums, or pipes, can cause them to blow up. Sparks can fly off from the welding arc. The flying sparks, hot workpiece, and hot equipment can cause fires and burns.

Accidental contact of electrode to metal objects can cause sparks, explosion, overheating, or fire. Check and be sure the area is safe before doing any welding.

- Remove all flammables within 35 ft (10.7 m) of the welding arc. If this is not possible, tightly cover them with approved covers.
- Do not weld where flying sparks can strike flammable material.
- Protect yourself and others from flying sparks and hot metal.
- Be alert that welding sparks and hot materials from welding can easily go through small cracks and openings to adjacent areas.
- Watch for fire, and keep a fire extinguisher nearby.
- Be aware that welding on a ceiling, floor, bulkhead, or partition can cause fire on the hidden side.
- Do not cut or weld on tire rims or wheels. Tires can explode if heated. Repaired rims and wheels can fail. See OSHA 29 CFR 1910.177 listed in Safety Standards.
- Do not weld on containers that have held combustibles, or on closed containers such as tanks, drums, or pipes unless they are properly prepared according to AWS F4.1 (see Safety Standards).
- Do not weld where the atmosphere can contain flammable dust, gas, or liquid vapors (such as gasoline).
- Connect work cable to the work as close to the welding area as practical to prevent welding current from traveling long, possibly unknown paths and causing electric shock, sparks, and fire hazards.
- Do not use welder to thaw frozen pipes.
- Remove stick electrode from holder or cut off welding wire at contact tip when not in use.
- Wear body protection made from leather or flame-resistant clothing (FRC). Body protection includes oil-free clothing such as leather gloves, heavy shirt, cuffless trousers, high shoes, and a cap.
- Remove any combustibles, such as a butane lighter or matches, from your person before doing any welding.
- After completion of work, inspect area to ensure it is free of sparks, glowing embers, and flames.
- Use only correct fuses or circuit breakers. Do not oversize or bypass them.
- Follow requirements in OSHA 1910.252 (a) (2) (iv) and NFPA 51B for hot work and have a fire watcher and extinguisher nearby.
- Read and understand the Safety Data Sheets (SDSs) and the manufacturer's instructions for adhesives, coatings, cleaners, consumables, coolants, degreasers, fluxes, and metals.

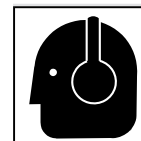

NOISE can damage hearing.

Noise from some processes or equipment can damage hearing.

- Wear approved ear protection if noise level is high.



ELECTRIC AND MAGNETIC FIELDS (EMF) can affect Implanted Medical Devices.

- Wearers of Pacemakers and other Implanted Medical Devices should keep away.
- Implanted Medical Device wearers should consult their doctor and the device manufacturer before going near arc welding, spot welding, gouging, plasma arc cutting, or induction heating operations.

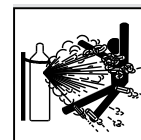

CYLINDERS can explode if damaged.

Compressed gas cylinders contain gas under high pressure. If damaged, a cylinder can explode. Since gas cylinders are normally part of the welding process, be sure to treat them carefully.

- Protect compressed gas cylinders from excessive heat, mechanical shocks, physical damage, slag, open flames, sparks, and arcs.

- Install cylinders in an upright position by securing to a stationary support or cylinder rack to prevent falling or tipping.
- Keep cylinders away from any welding or other electrical circuits.
- Never drape a welding torch over a gas cylinder.
- Never allow a welding electrode to touch any cylinder.
- Never weld on a pressurized cylinder—explosion will result.
- Use only correct compressed gas cylinders, regulators, hoses, and fittings designed for the specific application; maintain them and associated parts in good condition.

- Turn face away from valve outlet when opening cylinder valve. Do not stand in front of or behind the regulator when opening the valve.
- Keep protective cap in place over valve except when cylinder is in use or connected for use.
- Use the proper equipment, correct procedures, and sufficient number of persons to lift, move, and transport cylinders.
- Read and follow instructions on compressed gas cylinders, associated equipment, and Compressed Gas Association (CGA) publication P-1 listed in Safety Standards.

1-3. Engine Hazards



BATTERY EXPLOSION can injure.

- Always wear a face shield, rubber gloves, and protective clothing when working on a battery.
- Stop engine before disconnecting or connecting battery cables, battery charging cables (if applicable), or servicing battery.
- Do not allow tools to cause sparks when working on a battery.
- Do not use welder to charge batteries or jump start vehicles unless the unit has a battery charging feature designed for this purpose.
- Observe correct polarity (+ and -) on batteries.
- Disconnect negative (-) cable first and connect it last.
- Keep sparks, flames, cigarettes, and other ignition sources away from batteries. Batteries produce explosive gases during normal operation and when being charged.
- Follow battery manufacturer's instructions when working on or near a battery. See Battery Service Manual (listed in Safety Standards) for additional information.



FUEL can cause fire or explosion. ENGINE HEAT can cause fire.

- Stop engine and let it cool off before checking or adding fuel.
- Do not add fuel while smoking or if unit is near any sparks or open flames.
- Do not overfill tank — allow room for fuel to expand.
- Do not spill fuel. If fuel is spilled, clean up before starting engine.
- Dispose of rags in a fireproof container.
- Always keep nozzle in contact with tank when fueling.
- Do not locate unit on, over, or near combustible surfaces or flammables.
- Keep exhaust and exhaust pipes way from flammables.



MOVING PARTS can injure.

- Keep away from moving parts such as fans, belts, and rotors.
- Keep all doors, panels, covers, and guards closed and securely in place.
- Stop engine before installing or connecting unit.
- Have only qualified persons remove doors, panels, covers, or guards for maintenance and troubleshooting as necessary.
- To prevent accidental starting during servicing, disconnect negative (-) battery cable from battery.
- Keep hands, hair, loose clothing, and tools away from moving parts.
- Reinstall doors, panels, covers, or guards when servicing is finished and before starting engine.

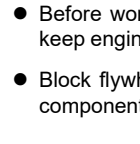

EXHAUST SPARKS can injure.

- Before working on generator, remove spark plugs or injectors to keep engine from kicking back or starting.
- Block flywheel so that it will not turn while working on generator components.
- Do not let engine exhaust sparks cause fire.
- Use approved engine exhaust spark arrestor in required areas — see applicable codes.



HOT PARTS can burn.

- Do not touch hot parts bare handed.
- Allow cooling period before working on equipment.
- To handle hot parts, use proper tools and/or wear heavy, insulated welding gloves and clothing to prevent burns.

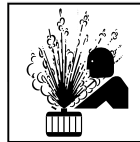

STEAM AND HOT COOLANT can burn.

- If possible, check coolant level when engine is cold to avoid scalding.
- Always check coolant level at overflow tank, if present on unit, instead of radiator (unless told otherwise in maintenance section or engine manual).
- If the engine is warm, checking is needed, and there is no overflow tank, follow the next two statements.
- Wear safety glasses and gloves and put a rag over radiator cap.
- Turn cap slightly and let pressure escape slowly before completely removing cap.

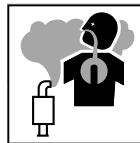

Using a generator indoors CAN KILL YOU IN MINUTES.

- Generator exhaust contains carbon monoxide. This is a poison you cannot see or smell.
- NEVER use inside a home or garage, EVEN IF doors and windows are open.
- Only use OUTSIDE and far away from windows, doors, and vents.

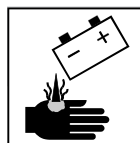

BATTERY ACID can BURN SKIN and EYES.

- Do not tip battery.
- Replace damaged battery.
- Flush eyes and skin immediately with water.

1-4. Compressed Air Hazards



COMPRESSED AIR EQUIPMENT can injure or kill.

- Incorrect installation or operation of this unit could result in equipment failure and personal injury. Only qualified persons should install, operate, and service this unit according to its Owner's Manual, industry standards, and national, state, and local codes.
- Do not exceed the rated output or capacity of the compressor or any equipment in the compressed air system. Design compressed air system so failure of any component will not put people or property at risk.
- Before working on compressed air system, turn off and lockout/tagout unit, release pressure, and be sure air pressure cannot be accidentally applied.
- Do not work on compressed air system with unit running unless you are a qualified person and following the manufacturer's instructions.
- Do not modify or alter compressor or manufacturer-supplied equipment. Do not disconnect, disable, or override any safety equipment in the compressed air system.
- Use only components and accessories approved by the manufacturer.
- Keep away from potential pinch points or crush points created by equipment connected to the compressed air system.
- Do not work under or around any equipment that is supported only by air pressure. Properly support equipment by mechanical means.



HOT METAL from air arc cutting and gouging can cause fire or explosion.

- Do not cut or gouge near flammables.
- Watch for fire; keep extinguisher nearby.



COMPRESSED AIR can injure or kill.

- Before working on compressed air system, turn off and lockout/tagout unit, release pressure, and be sure air pressure cannot be accidentally applied.
- Relieve pressure before disconnecting or connecting air lines.
- Check compressed air system components and all connections and hoses for damage, leaks, and wear before operating unit.
- Do not direct air stream toward self or others.

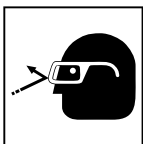

- Wear protective equipment such as safety glasses, hearing protection, leather gloves, heavy shirt and trousers, high shoes, and a cap when working on compressed air system.
- Use soapy water or an ultrasonic detector to search for leaks—never use bare hands. Do not use equipment if leaks are found.

- Reinstall doors, panels, covers, or guards when servicing is finished and before starting unit.
- If ANY air is injected into the skin or body seek medical help immediately.



BREATHING COMPRESSED AIR can injure or kill.

- Do not use compressed air for breathing.
- Use only for cutting, gouging, and tools.



TRAPPED AIR PRESSURE AND WHIPPING HOSES can injure.

- Release air pressure from tools and system before servicing, adding or changing attachments, or opening compressor oil drain or oil fill cap.



MOVING PARTS can injure.

- Keep away from moving parts such as fans, belts and rotors.
- Keep all doors, panels, covers, and guards closed and securely in place.
- Keep hands, hair, loose clothing, and tools away from moving parts.
- Before working on compressed air system, turn off and lockout/tagout unit, release pressure, and be sure air pressure cannot be accidentally applied.
- Have only qualified people remove guards or covers for maintenance and troubleshooting as necessary.
- Reinstall doors, panels, covers, or guards when servicing is finished and before starting engine.



HOT PARTS can burn.

- Do not touch hot compressor or air system parts.
- Allow cooling period before working on equipment.
- To handle hot parts, use proper tools and/or wear heavy, insulated welding gloves and clothing to

prevent burns.

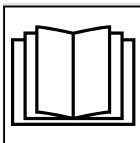

READ INSTRUCTIONS.

- Read and follow all labels and the Owner's Manual carefully before installing, operating, or servicing unit. Read the safety information at the beginning of the manual and in each section.

- Use only genuine replacement parts from the manufacturer.
- Perform installation, maintenance, and service according to the Owner's Manuals, industry standards, and national, state, and local codes.

1-5. Additional Hazards For Installation, Operation, And Maintenance



FIRE OR EXPLOSION hazard.

- Do not install or place unit on, over, or near combustible surfaces.
- Do not install unit near flammables.
- Do not overload building wiring—be sure power supply system is properly sized, rated, and protected to handle this unit.



FALLING EQUIPMENT can injure.

- Use lifting eye to lift unit and properly installed accessories only, NOT gas cylinders. Do not exceed maximum lift eye weight rating (see Specifications).
- Use correct procedures and equipment of adequate capacity to lift and support unit.
- If using lift forks to move unit, be sure forks are long enough to extend beyond opposite side of unit.
- Keep equipment (cables and cords) away from moving vehicles when working from an aerial location.

- Follow the guidelines in the Applications Manual for the Revised NIOSH Lifting Equation (Publication No. 94-110) when manually lifting heavy parts or equipment.



OVERHEATING can damage motors.

- Turn off or unplug equipment before starting or stopping engine.
- Do not let low voltage and frequency caused by low engine speed damage electric motors.
- Use only equipment suitable for operation on 60 or 50/60 Hz power.

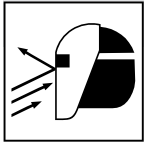

FLYING SPARKS can injure.

- Wear a face shield to protect eyes and face.
- Shape tungsten electrode only on grinder with proper guards in a safe location wearing proper face, hand, and body protection.
- Sparks can cause fires—keep flammables away.



MOVING PARTS can injure.

- Keep away from moving parts.
- Keep away from pinch points such as drive rolls.



BATTERY CHARGING OUTPUT and BATTERY EXPLOSION can injure.

Battery charging not present on all models.

- Always wear a face shield, rubber gloves, and protective clothing when working on a battery.
- Stop engine before disconnecting or connecting battery cables, battery charging cables (if applicable), or servicing battery.
- Do not allow tools to cause sparks when working on a battery.
- Do not use welder to charge batteries or jump start vehicles unless it has a battery charging feature designed for this purpose.
- Observe correct polarity (+ and -) on batteries.
- Disconnect negative (-) cable first and connect it last.
- Keep sparks, flames, cigarettes, and other ignition sources away from batteries. Batteries produce explosive gases during normal operation and when being charged.
- Follow battery manufacturer's instructions when working on or near a battery. See Battery Service Manual (listed in Safety Standards) for additional information.
- Have only qualified persons do battery charging work.
- If battery is being removed from a vehicle for charging, disconnect negative (-) cable first and connect it last. To prevent an arc, make sure all accessories are off.
- Charge lead-acid batteries only. Do not use battery charger to supply power to an extra-low-voltage electrical system or to charge dry cell batteries.
- Do not charge a frozen battery.
- Do not use damaged charging cables.
- Do not charge batteries in a closed area or where ventilation is restricted.
- Do not charge a battery that has loose terminals or one showing damage such as a cracked case or cover.
- Before charging battery, select correct charger voltage to match battery voltage.
- Set battery charging controls to the Off position before connecting to battery. Do not allow battery charging clips to touch each other.
- Keep charging cables away from vehicle hood, door, or moving parts.



HIGH PRESSURE FLUIDS can injure or kill.

- Engine fuel system components can be under high pressure.
- Before working on fuel system, turn off engine to release pressure.
- If any fluid is injected into the skin or body seek medical help immediately.



WELDING WIRE can injure.

- Do not press gun trigger until instructed to do so.
- Do not point gun toward any part of the body, other people, or any metal when threading welding wire.

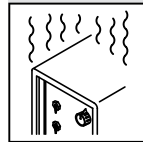

OVERUSE can cause OVERHEATING.

- Allow cooling period; follow rated duty cycle.
- Reduce current or reduce duty cycle before starting to weld again.
- Do not block or filter airflow to unit.

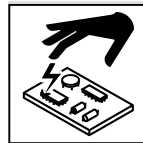

STATIC (ESD) can damage PC boards.

- Put on grounded wrist strap BEFORE handling boards or parts.
- Use proper static-proof bags and boxes to store, move, or ship PC boards.



TILTING OF TRAILER can injure.

- Use tongue jack or blocks to support weight.
- Properly install welding generator onto trailer according to instructions supplied with trailer.

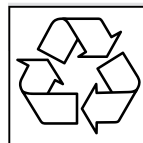

RECYCLE.

- Recycle or dispose of used liquids in an environmentally safe way. This is especially true for engine fluids such as drain oil and used coolant; this is also important for coolant from torch/gun cooling systems.
- Contact your local recycling office or your local distributor for information about how to dispose of parts and equipment in an environmentally safe way.

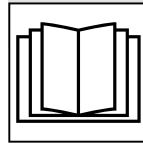

READ INSTRUCTIONS.

- Read and follow all labels and the Owner's Manual carefully before installing, operating, or servicing unit. Read the safety information at the beginning of the manual and in each section.
- Use only genuine replacement parts from the manufacturer.
- Perform installation, maintenance, and service according to the Owner's Manuals, industry standards, and national, state, and local codes.

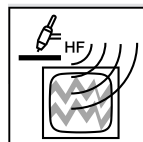

H.F. RADIATION can cause interference.

- High-frequency (H.F.) can interfere with radio navigation, safety services, computers, and communications equipment.
- Have only qualified persons familiar with electronic equipment perform this installation.
- The user is responsible for having a qualified electrician promptly correct any interference problem resulting from the installation.

- If notified by the FCC about interference, stop using the equipment at once.
- Have the installation regularly checked and maintained.
- Keep high-frequency source doors and panels tightly shut, keep spark gaps at correct setting, and use grounding and shielding to minimize the possibility of interference.



ARC WELDING can cause interference.

as robots.

- Electromagnetic energy can interfere with sensitive electronic equipment such as microprocessors, computers, and computer-driven equipment such

- Be sure all equipment in the welding area is electromagnetically compatible.
- To reduce possible interference, keep weld cables as short as possible, close together, and down low, such as on the floor.
- Locate welding operation 100 meters from any sensitive electronic equipment.
- Be sure this welding machine is installed and grounded according to this manual.
- If interference still occurs, the user must take extra measures such as moving the welding machine, using shielded cables, using line filters, or shielding the work area.

1-6. California Proposition 65 Warnings

⚠ WARNING – This product can expose you to chemicals including lead, which are known to the state of California to cause cancer and birth defects or other reproductive harm.

For more information, go to www.P65Warnings.ca.gov.

For Diesel Engines:

⚠ WARNING – Breathing diesel engine exhaust exposes you to chemicals known to the state of California to cause cancer and birth defects or other reproductive harm.

- Always start and operate the engine in a well-ventilated area.
- If in an enclosed area, vent the exhaust to the outside.
- Do not modify or tamper with the exhaust system.
- Do not idle the engine except as necessary.

For more information, go to www.P65Warnings.ca.gov/diesel.

1-7. Principal Safety Standards

Safety in Welding, Cutting, and Allied Processes, American Welding Society standard ANSI Standard Z49.1. Website: <http://www.aws.org>.

Safe Practices for the Preparation of Containers and Piping for Welding and Cutting, American Welding Society Standard AWS F4.1. Website: <http://www.aws.org>.

National Electrical Code, NFPA Standard 70 from National Fire Protection Association. Website: www.nfpa.org.

Safe Handling of Compressed Gases in Cylinders, CGA Pamphlet P-1 from Compressed Gas Association. Website: www.cganet.com.

Safety in Welding, Cutting, and Allied Processes, CSA Standard W117.2 from Canadian Standards Association. Website: www.csagroup.org.

Battery Chargers, CSA Standard C22.2 NO 107.2-01 from Canadian Standards Association. Website: www.csagroup.org.

Safe Practice For Occupational And Educational Eye And Face Protection, ANSI Standard Z87.1, from American National Standards Institute. Website: www.ansi.org.

Standard for Fire Prevention During Welding, Cutting, and Other Hot Work, NFPA Standard 51B from National Fire Protection Association. Website: www.nfpa.org.

OSHA, Occupational Safety and Health Standards for General Industry, Title 29, Code of Federal Regulations (CFR), Part 1910.177 Subpart N, Part 1910 Subpart Q, and Part 1926, Subpart J. Website: www.osha.gov.

OSHA Important Note Regarding the ACGIH TLV, Policy Statement on the Uses of TLVs and BEIs. Website: www.osha.gov.

Portable Generator Hazards Safety Alert from U.S. Consumer Product Safety Commission (CPSC). Website: www.cpsc.gov.

Applications Manual for the Revised NIOSH Lifting Equation from the National Institute for Occupational Safety and Health (NIOSH). Website: www.cdc.gov/NIOSH.

For Standards regulating hydraulic systems, contact the National Fluid Power Association. Website: www.nfpa.com.

Battery Service Manual from the Battery Council International. Website: www.batterycouncil.org.

ROM 2022-01

1-8. EMF Information

Electric current flowing through any conductor causes localized electric and magnetic fields (EMF). The current from arc welding (and allied processes including spot welding, gouging, plasma arc cutting, and induction heating operations) creates an EMF field around the welding circuit. EMF fields can interfere with some medical implants, e.g. pacemakers. Protective measures for persons wearing medical implants have to be taken. For example, restrict access for passers-by or conduct individual risk assessment for welders. All welders should use the following procedures in order to minimize exposure to EMF fields from the welding circuit:

1. Keep cables close together by twisting or taping them, or using a cable cover.
2. Do not place your body between welding cables. Arrange cables to one side and away from the operator.
3. Do not coil or drape cables around your body.

4. Keep head and trunk as far away from the equipment in the welding circuit as possible.
5. Connect work clamp to workpiece as close to the weld as possible.
6. Do not work next to, sit or lean on the welding power source.
7. Do not weld whilst carrying the welding power source or wire feeder.

About Implanted Medical Devices:

Implanted Medical Device wearers should consult their doctor and the device manufacturer before performing or going near arc welding, spot welding, gouging, plasma arc cutting, or induction heating operations. If cleared by your doctor, then following the above procedures is recommended.

SECTION 2 – CONSIGNES DE SÉCURITÉ - LIRE AVANT UTILISATION

⚠ Pour écarter les risques de blessure pour vous-même et pour autrui — lire, appliquer et ranger en lieu sûr ces consignes relatives aux précautions de sécurité et au mode opératoire.

2-1. Symboles utilisés

⚠ **DANGER!** – Indique une situation dangereuse qui si on l'évite pas peut donner la mort ou des blessures graves. Les dangers possibles sont montrés par les symboles joints ou sont expliqués dans le texte.

⚠ Indique une situation dangereuse qui si on l'évite pas peut donner la mort ou des blessures graves. Les dangers possibles sont montrés par les symboles joints ou sont expliqués dans le texte.

AVIS – Indique des déclarations pas en relation avec des blessures personnelles.

👉 Indique des instructions spécifiques.



Ce groupe de symboles veut dire Avertissement! Attention! DANGER DE CHOC ELECTRIQUE, PIECES EN MOUVEMENT, et PIECES CHAUDES. Reportez-vous aux symboles et aux directives ci-dessous afin de connaître les mesures à prendre pour éviter tout danger.

2-2. Dangers relatifs au soudage à l'arc

⚠ Les symboles représentés ci-dessous sont utilisés dans ce manuel pour attirer l'attention et identifier les dangers possibles. En présence de ce symbole, prendre garde et suivre les instructions afférentes pour éviter tout risque. Les consignes de sécurité présentées ci-après ne font que résumer l'information contenue dans les Normes de sécurité principales. Lire et suivre toutes les Normes de sécurité.

⚠ L'installation, l'utilisation, l'entretien et les réparations ne doivent être confiés qu'à des personnes qualifiées. Une personne qualifiée est définie comme celle qui, par la possession d'un diplôme reconnu, d'un certificat ou d'un statut professionnel, ou qui, par une connaissance, une formation et une expérience approfondies, a démontré avec succès sa capacité à résoudre les problèmes liés à la tâche, le travail ou le projet et a reçu une formation en sécurité afin de reconnaître et d'éviter les risques inhérents.

⚠ Au cours de l'utilisation, tenir toute personne à l'écart et plus particulièrement les enfants.



UN CHOC ÉLECTRIQUE peut tuer.

Un simple contact avec des pièces électriques peut provoquer une électrocution ou des blessures graves. L'électrode et le circuit de soudage sont sous tension dès que l'appareil est sur ON. Le circuit d'entrée et les circuits internes de l'appareil sont également sous tension à ce moment-là. En soudage semi-automatique ou automatique, le fil, le dévidoir, le logement des galets d'entraînement et les pièces métalliques en contact avec le fil de soudage sont sous tension. Des matériels mal installés ou mal mis à la terre présentent un danger.

- Ne jamais toucher les pièces électriques sous tension.
- Porter des gants et des vêtements de protection secs ne comportant pas de trous.
- S'isoler de la pièce et de la terre au moyen de tapis ou d'autres moyens isolants suffisamment grands pour empêcher le contact physique éventuel avec la pièce ou la terre.
- Ne pas utiliser de sortie de soudage CA dans des zones humides ou confinées ou s'il y a un risque de chute.
- Se servir d'une source électrique à courant électrique UNIQUEMENT si le procédé de soudage le demande.
- Si l'utilisation d'une source électrique à courant électrique s'avère nécessaire, se servir de la fonction de télécommande si l'appareil en est équipé.
- Des précautions de sécurité supplémentaires sont requises dans des environnements à risque comme: les endroits humides ou lorsque l'on porte des vêtements mouillés; sur des structures métalliques au sol, grillages et échafaudages; dans des positions assises, à genoux et allongées; ou quand il y a un risque important

de contact accidentel avec la pièce ou le sol. Dans ces cas utiliser les appareils suivants dans l'ordre de préférence: 1) un poste à souder DC semi-automatique de type CV (MIG/MAG), 2) un poste à souder manuel (électrode enrobée) DC, 3) un poste à souder manuel AC avec tension à vide réduite. Dans la plupart des cas, un poste courant continu de type CV est recommandé. Et, ne pas travailler seul!

- Ne brancher aucun système de distribution électrique normalement fourni par un réseau public à moins qu'un commutateur de transfert et une procédure de mise à la terre adéquats ne soient mis en place.
- Couper l'alimentation ou arrêter le moteur avant de procéder à l'installation, à la réparation ou à l'entretien de l'appareil. Déverrouiller l'alimentation selon la norme OSHA 29 CFR 1910.147 (voir normes de sécurité).
- Installer et mettre à la terre correctement cet appareil conformément à son manuel d'utilisation et aux codes nationaux, provinciaux et municipaux.
- Toujours vérifier la terre du cordon d'alimentation - Vérifier et s'assurer que le fil de terre du cordon d'alimentation est bien raccordé à la borne de terre du sectionneur ou que la fiche du cordon est raccordée à une prise correctement mise à la terre.
- En effectuant les raccordements d'entrée fixer d'abord le conducteur de mise à la terre approprié et contre-vérifier les connexions.
- Les câbles doivent être exempts d'humidité, d'huile et de graisse; protégez-les contre les étincelles et les pièces métalliques chaudes.
- Vérifier fréquemment le cordon d'alimentation et le conducteur de mise à la terre afin de s'assurer qu'il n'est pas altéré ou dénudé -, le remplacer immédiatement s'il l'est -. Un fil dénudé peut entraîner la mort.
- Mettre l'appareil hors tension quand on ne l'utilise pas.
- Ne pas utiliser des câbles usés, endommagés, sous dimensionnés ou réparés.
- Ne pas enrouler les câbles autour du corps.
- Si la pièce soudée doit être mise à la terre, le faire directement avec un câble distinct - ne pas utiliser le connecteur de pièce ou le câble de retour.
- Ne pas toucher l'électrode quand on est en contact avec la pièce, la terre ou une électrode provenant d'une autre machine.
- Ne pas toucher des porte électrodes connectés à deux machines en même temps à cause de la présence d'une tension à vide doublée.
- N'utiliser qu'un matériel en bon état. Réparer ou remplacer sur-le-champ les pièces endommagées. Entretien l'appareil conformément à ce manuel.

- Ne pas toucher aux portes-électrodes qui sont raccordés à deux machines à souder en même temps, car cela entraîne la présence d'une tension de circuit-ouvert double.
- Porter un harnais de sécurité quand on travaille en hauteur.
- Maintenir solidement en place tous les panneaux et capots.
- Fixer le câble de retour de façon à obtenir un bon contact métal-métal avec la pièce à souder ou la table de travail, le plus près possible de la soudure.
- Isoler la pince de masse quand pas mis à la pièce pour éviter le contact avec tout objet métallique.
- Ne pas raccorder plus d'une électrode ou plus d'un câble de masse à une même borne de sortie de soudage. Débrancher le câble pour le procédé non utilisé.
- Utiliser une protection GFCI lors de l'utilisation d'appareils auxiliaires. Testez les prises GFCI à haute vitesse.



LES PIÈCES CHAUDES peuvent provoquer des brûlures.

- Ne pas toucher des parties chaudes à mains nues.
- Prévoir une période de refroidissement avant de travailler à l'équipement.
- Ne pas toucher aux pièces chaudes, utiliser les outils recommandés et porter des gants de soudage et des vêtements épais pour éviter les brûlures.

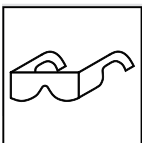

DES PIÈCES DE METAL ou DES SALETES peuvent provoquer des blessures dans les yeux.

- Le soudage, l'écaillage, le passage de la pièce à la brosse en fil de fer, et le meulage génèrent des étincelles et des particules métalliques volantes. Pendant la période de refroidissement des soudures, elles risquent de projeter du laitier.
- Porter des lunettes de sécurité avec écrans latéraux ou un écran facial.



LES FUMÉES ET LES GAZ peuvent être dangereux.

Le soudage génère des fumées et des gaz. Leur inhalation peut être dangereux pour votre santé.

- Eloigner votre tête des fumées. Ne pas respirer les fumées.
- À l'intérieur, ventiler la zone et/ou utiliser une ventilation forcée au niveau de l'arc pour l'évacuation des fumées et des gaz de soudage. Pour déterminer la bonne ventilation, il est recommandé de procéder à un prélèvement pour la composition et la quantité de fumées et de gaz auxquelles est exposé le personnel.
- Si la ventilation est médiocre, porter un respirateur anti-vapeurs approuvé.
- Lire et comprendre les fiches de données de sécurité et les instructions du fabricant concernant les adhésifs, les revêtements, les nettoyants, les consommables, les produits de refroidissement, les dégraissages, les flux et les métaux.
- Travailler dans un espace fermé seulement s'il est bien ventilé ou en portant un respirateur à alimentation d'air. Demander toujours à un surveillant dûment formé de se tenir à proximité. Des fumées et des gaz de soudage peuvent déplacer l'air et abaisser le niveau d'oxygène provoquant des blessures ou des accidents mortels. S'assurer que l'air de respiration ne présente aucun danger.
- Ne pas souder dans des endroits situés à proximité d'opérations de dégraissage, de nettoyage ou de pulvérisation. La chaleur et les rayons de l'arc peuvent réagir en présence de vapeurs et former des gaz hautement toxiques et irritants.
- Ne pas souder des métaux munis d'un revêtement, tels que l'acier galvanisé, plaqué en plomb ou au cadmium à moins que le revêtement n'ait été enlevé dans la zone de soudure, que l'endroit soit

bien ventilé, et en portant un respirateur à alimentation d'air. Les revêtements et tous les métaux renfermant ces éléments peuvent dégager des fumées toxiques en cas de soudage.



LES ACCUMULATIONS DE GAZ risquent de provoquer des blessures ou même la mort.

- Fermer l'alimentation du gaz comprimé en cas de non utilisation.
- Veiller toujours à bien aérer les espaces confinés ou se servir d'un respirateur d'adduction d'air homologué.

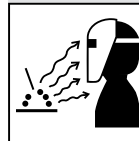

LES RAYONS DE L'ARC peuvent provoquer des brûlures dans les yeux et sur la peau.

Le rayonnement de l'arc du procédé de soudage génère des rayons visibles et invisibles intenses (ultraviolets et infrarouges) susceptibles de provoquer des brûlures dans les yeux et sur la peau. Des étincelles sont projetées pendant le soudage.

- Porter un casque de soudage approuvé muni de verres filtrants approprié pour protéger visage et yeux pendant le soudage (voir ANSI Z49.1 et Z87.1 énuméré dans les normes de sécurité).
- Porter des lunettes de sécurité avec écrans latéraux même sous votre casque.
- Avoir recours à des écrans protecteurs ou à des rideaux pour protéger les autres contre les rayonnements les éblouissements et les étincelles ; prévenir toute personne sur les lieux de ne pas regarder l'arc.
- Porter une protection corporelle en cuir ou des vêtements ignifuges (FRC). La protection du corps comporte des vêtements sans huile, comme des gants de cuir, une chemise solide, des pantalons sans revers, des chaussures hautes et une casquette.

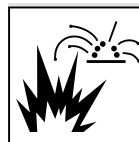

LE SOUDAGE peut provoquer un incendie ou une explosion.

Le soudage effectué sur des conteneurs fermés tels que des réservoirs, tambours ou des conduites peut provoquer leur éclatement. Des étincelles peuvent être projetées de l'arc de soudure. La projection d'étincelles, des pièces chaudes et des équipements chauds peut provoquer des incendies et des brûlures. Le contact accidentel de l'électrode avec des objets métalliques peut provoquer des étincelles, une explosion, un surchauffement ou un incendie. Avant de commencer le soudage, vérifier et s'assurer que l'endroit ne présente pas de danger.

- Déplacer toutes les substances inflammables à une distance de 10,7 m de l'arc de soudage. En cas d'impossibilité les recouvrir soigneusement avec des protections homologués.
- Ne pas souder dans un endroit où des étincelles peuvent tomber sur des substances inflammables.
- Se protéger et d'autres personnes de la projection d'étincelles et de métal chaud.
- Des étincelles et des matériaux chauds du soudage peuvent facilement passer dans d'autres zones en traversant de petites fissures et des ouvertures.
- Surveiller tout déclenchement d'incendie et tenir un extincteur à proximité.
- Le soudage effectué sur un plafond, plancher, paroi ou séparation peut déclencher un incendie de l'autre côté.
- Ne pas couper ou souder des jantes ou des roues. Les pneus peuvent exploser s'ils sont chauffés. Les jantes et les roues réparées peuvent défaillir. Voir OSHA 29 CFR 1910.177 énuméré dans les normes de sécurité.
- Ne pas effectuer le soudage sur des conteneurs fermés tels que des réservoirs, tambours, ou conduites, à moins qu'ils n'aient été préparés correctement conformément à AWS F4.1 (voir les Normes de Sécurité).

- Ne pas souder là où l'air ambiant pourrait contenir des poussières, gaz ou émanations inflammables (vapeur d'essence, par exemple).
- Brancher le câble de masse sur la pièce le plus près possible de la zone de soudage pour éviter le transport du courant sur une longue distance par des chemins inconnus éventuels en provoquant des risques d'électrocution, d'étincelles et d'incendie.
- Ne pas utiliser le poste de soudage pour dégelier des conduites gelées.
- En cas de non utilisation, enlever la baguette d'électrode du porte-électrode ou couper le fil à la pointe de contact.
- Porter une protection corporelle en cuir ou des vêtements ignifuges (FRC). La protection du corps comporte des vêtements sans huile, comme des gants de cuir, une chemise solide, des pantalons sans revers, des chaussures hautes et une casquette.
- Avant de souder, retirer toute substance combustible de vos poches telles qu'un allumeur au butane ou des allumettes.
- Une fois le travail achevé, assurez-vous qu'il ne reste aucune trace d'étincelles incandescentes ni de flammes.
- Utiliser exclusivement des fusibles ou coupe-circuits appropriés. Ne pas augmenter leur puissance; ne pas les ponter.
- Suivre les recommandations dans OSHA 1910.252 (a) (2) (iv) et NFPA 51B pour les travaux à chaud et avoir de la surveillance et un extincteur à proximité.
- Lire et comprendre les fiches de données de sécurité et les instructions du fabricant concernant les adhésifs, les revêtements, les nettoyants, les consommables, les produits de refroidissement, les dégraisseurs, les flux et les métaux.



Le BRUIT peut endommager l'ouïe.

Le bruit des processus et des équipements peut affecter l'ouïe.

- Porter des protections approuvées pour les oreilles si le niveau sonore est trop élevé.



Les CHAMPS ÉLECTROMAGNÉTIQUES (CEM) peuvent affecter les implants médicaux.

- Les porteurs de stimulateurs cardiaques et autres implants médicaux doivent rester à distance.

- Les porteurs d'implants médicaux doivent consulter leur médecin et le fabricant du dispositif avant de s'approcher de la zone où se déroule le soudage à l'arc, du soudage par points, du gougeage, de la découpe plasma ou une opération de chauffage par induction.

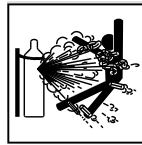

Si des BOUTEILLES sont endommagées, elles pourront exploser.

Des bouteilles de gaz comprimé protecteur contiennent du gaz sous haute pression. Si une bouteille est endommagée, elle peut exploser. Du fait que les bouteilles de gaz font normalement partie du procédé de soudage, les manipuler avec précaution.

- Protéger les bouteilles de gaz comprimé d'une chaleur excessive, des chocs mécaniques, des dommages physiques, du laitier, des flammes ouvertes, des étincelles et des arcs.
- Placer les bouteilles debout en les fixant dans un support stationnaire ou dans un porte-bouteilles pour les empêcher de tomber ou de se renverser.
- Tenir les bouteilles éloignées des circuits de soudage ou autres circuits électriques.
- Ne jamais placer une torche de soudage sur une bouteille à gaz.
- Une électrode de soudage ne doit jamais entrer en contact avec une bouteille.
- Ne jamais souder une bouteille pressurisée - risque d'explosion.
- Utiliser seulement des bouteilles de gaz comprimé, régulateurs, tuyaux et raccords convenables pour cette application spécifique; les maintenir ainsi que les éléments associés en bon état.
- Tourner le dos à la sortie de vanne lors de l'ouverture de la vanne de la bouteille. Ne pas se tenir devant ou derrière le régulateur lors de l'ouverture de la vanne.
- Maintenir le chapeau de protection sur la soupape, sauf en cas d'utilisation ou de branchement de la bouteille.
- Utilisez les équipements corrects, les bonnes procédures et suffisamment de personnes pour soulever, déplacer et transporter les bouteilles.
- Lire et suivre les instructions sur les bouteilles de gaz comprimé, l'équipement connexe et le dépliant P-1 de la CGA (Compressed Gas Association) mentionné dans les principales normes de sécurité.

2-3. Dangers existant en relation avec le moteur



L'EXPLOSION DE LA BATTERIE peut provoquer des blessures.

- Toujours porter une protection faciale, des gants en caoutchouc et vêtements de protection lors d'une intervention sur la batterie.
- Arrêter le moteur avant de débrancher ou de brancher des câbles de batterie, des câbles de chargeur de batterie (le cas échéant) ou de batterie d'entretien.
- Eviter de provoquer des étincelles avec les outils en travaillant sur la batterie.
- Ne pas utiliser l'appareil de soudage pour charger des batteries ou faire démarrer des véhicules à l'aide de câbles de démarrage, sauf si l'appareil dispose d'une fonctionnalité de charge de batterie destinée à cet usage.
- Observer la polarité correcte (+ et -) sur les batteries.
- Débrancher le câble négatif (-) en premier lieu. Le rebrancher en dernier lieu.
- Les sources d'étincelles, flammes nues, cigarettes et autres sources d'inflammation doivent être maintenues à l'écart des batteries. Ces dernières produisent des gaz explosifs en fonctionnement normal et en cours de charge.



LE CARBURANT MOTEUR peut provoquer un incendie ou une explosion. LA CHALEUR DU MOTEUR peut provoquer un incendie.

- Suivre les instructions du fabricant de la batterie lors d'opérations sur une batterie ou à proximité de celle-ci. Voir le manuel de service de batterie (indiqué dans Normes de sécurité) pour plus d'informations.
- Arrêter le moteur avant de vérifier le niveau de carburant ou de faire le plein.
- Ne pas faire le plein en fumant ou proche d'une source d'étincelles ou d'une flamme nue.
- Ne pas faire le plein de carburant à ras bord; prévoir de l'espace pour son expansion.
- Faire attention de ne pas renverser de carburant. Nettoyer tout carburant renversé avant de faire démarrer le moteur.
- Jeter les chiffons dans un récipient ignifuge.
- Toujours garder le pistolet en contact avec le réservoir lors du remplissage.

- Ne pas placer l'appareil sur, au-dessus ou à proximité de surfaces inflammables.
- Tenir à distance les produits inflammables de l'échappement.



Les PIÈCES MOBILES peuvent causer des blessures.

- S'abstenir de toucher des parties mobiles telles que des ventilateurs, courroies et rotors.
- Maintenir fermés et verrouillés les portes, panneaux, recouvrements et dispositifs de protection.
- Arrêter le moteur avant d'installer ou brancher l'appareil.
- Lorsque cela est nécessaire pour des travaux d'entretien et de dépannage, faire retirer les portes, panneaux, recouvrements ou dispositifs de protection uniquement par du personnel qualifié.
- Pour empêcher tout démarrage accidentel pendant les travaux d'entretien, débrancher le câble négatif (-) de batterie delaborne.
- Ne pas approcher les mains, cheveux, vêtements lâches et outils des organes mobiles.
- Remettre en place les portes, panneaux, recouvrements ou dispositifs de protection à la fin des travaux d'entretien et avant de mettre le moteur en marche.
- Avant d'intervenir, déposer les bougies ou injecteurs pour éviter la mise en route accidentelle du moteur.
- Bloquer le volant moteur pour éviter sa rotation lors d'une intervention sur le générateur.



LES ÉTINCELLES À L'ÉCHAPPEMENT peuvent provoquer un incendie.

- Empêcher les étincelles d'échappement du moteur de provoquer un incendie.
- Utiliser uniquement un pare-étincelles approuvé - voir codes en vigueur.



LES PIÈCES CHAUDES peuvent provoquer des brûlures.

- Ne pas toucher des parties chaudes à mains nues.
- Prévoir une période de refroidissement avant de travailler à l'équipement.

- Ne pas toucher aux pièces chaudes, utiliser les outils recommandés et porter des gants de soudage et des vêtements épais pour éviter les brûlures.



LA VAPEUR ET LE LIQUIDE DE REFROIDISSEMENT CHAUD peuvent provoquer des brûlures.

- Il est préférable de vérifier le liquide de refroidissement une fois le moteur refroidi pour éviter de se brûler.
- Toujours vérifier le niveau de liquide de refroidissement dans le vase d'expansion (si présent), et non dans le radiateur (sauf si précisé autrement dans la section maintenance du manuel du moteur).
- Si le moteur est chaud et que le liquide doit être vérifié, opérer comme suivant.
- Mettre des lunettes de sécurité et des gants, placer un torchon sur le bouchon du radiateur.
- Dévisser le bouchon légèrement et laisser la vapeur s'échapper avant d'enlever le bouchon.



L'utilisation d'un groupe autonome à l'intérieur PEUT VOUS TUER EN QUELQUES MINUTES.

- Les fumées d'un groupe autonome contient du monoxyde de carbone. C'est un poison invisible et inodore.
- JAMAIS utiliser dans une maison ou garage, même avec les portes et fenêtres ouvertes.
- Uniquement utiliser à l'EXTERIEUR, loin des portes, fenêtres et bouches aération.

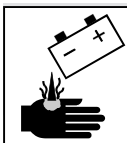

L'ACIDE DE LA BATTERIE peut provoquer des brûlures dans les YEUX ET SUR LA PEAU.

- Ne pas renverser la batterie.
- Remplacer une batterie endommagée.
- Rincer immédiatement les yeux et la peau à l'eau.

2-4. Dangers liés à l'air comprimé



Un ÉQUIPEMENT PNEUMATIQUE risque de provoquer des blessures ou même la mort.

- Une installation ou une utilisation incorrecte de cet appareil pourrait conduire à des dégâts matériels ou corporels. Seul un personnel qualifié est autorisé à installer, utiliser et entretenir cet appareil conformément à son manuel d'utilisation, aux normes industrielles et aux codes nationaux, d'état ou locaux.
- Ne pas dépasser le débit nominal ou la capacité du compresseur ou de tout équipement du circuit d'air comprimé. Concevoir le circuit d'air comprimé de telle sorte que la défaillance d'un composant ne risque pas de provoquer un accident matériel ou corporel.
- Avant d'intervenir sur le circuit d'air comprimé, couper l'alimentation électrique, verrouiller et étiqueter l'appareil, détendre la pression et s'assurer que le circuit d'air ne peut être mis sous pression par inadvertance.
- Ne pas intervenir sur le circuit d'air comprimé lorsque l'appareil fonctionne. Seul un personnel qualifié est autorisé, et appliquant les consignes du fabricant.
- Ne pas modifier ou altérer le compresseur ou les équipements fournis par le fabricant. Ne pas débrancher, désactiver ou neutraliser les équipements de sécurité du circuit d'air comprimé.



MÉTAL CHAUD provenant du découpage ou du gougeage à l'arc risque de provoquer un incendie ou une explosion.

- Ne pas découper ou gouger à proximité de produits inflammables.
- Attention aux risques d'incendie: tenir un extincteur à proximité.



L'AIR COMPRIMÉ risque de provoquer des blessures ou même la mort.

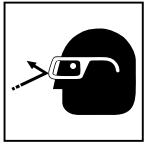

- Avant d'intervenir sur le circuit d'air comprimé, couper l'alimentation électrique, verrouiller et étiqueter l'appareil, détendre la pression et s'assurer que le circuit d'air ne peut être mis sous pression par inadvertance.
- Détendre la pression avant de débrancher ou de brancher des canalisations d'air.
- Avant d'utiliser l'appareil, contrôler les composants du circuit d'air comprimé, les branchements et les flexibles en recherchant tout signe de détérioration, de fuite et d'usure.
- Ne pas diriger un jet d'air vers soi-même ou vers autrui.
- Pour intervenir sur un circuit d'air comprimé, porter un équipement de protection tel que des lunettes de sécurité, des gants de cuir, une chemise et un pantalon en tissu résistant, des chaussures montantes et une coiffe.
- Pour rechercher des fuites, utiliser de l'eau savonneuse ou un détecteur à ultrasons, jamais les mains nues. En cas de détection de fuite, ne pas utiliser l'équipement.
- Remettre les portes, panneaux, recouvrements ou dispositifs de protection quand l'entretien est terminé et avant de mettre en marche l'appareil.
- En cas d'injection d'air dans la peau ou le corps, demander immédiatement une assistance médicale.



L'INHALATION D'AIR COMPRIMÉ risque de provoquer des blessures ou même la mort.

- Ne pas inhaler d'air comprimé.
- Utiliser l'air comprimé uniquement pour découper ou gouger ainsi que pour l'outillage pneumatique.



Une PRESSION D'AIR RÉSIDUELLE ET DES FLEXIBLES QUI FOUETTENT risquent de provoquer des blessures.

- Détendre la pression pneumatique des outils et circuits avant d'entretenir, ajouter ou changer des accessoires et avant d'ouvrir le bouchon de vidange ou de remplissage d'huile du compresseur.



Les PIÈCES MOBILES peuvent causer des blessures.

- S'abstenir de toucher des parties mobiles telles que des ventilateurs, courroies et rotors.
- Maintenir fermés et verrouillés les portes, panneaux, recouvrements et dispositifs de protection.
- Ne pas approcher les mains, cheveux, vêtements lâches et outils des organes mobiles.
- Avant d'intervenir sur le circuit d'air comprimé, couper l'alimentation électrique, verrouiller et étiqueter l'appareil, détendre la pression et s'assurer que le circuit d'air ne peut être mis sous pression par inadvertance.
- Demander seulement à un personnel qualifié d'enlever les dispositifs de sécurité ou les recouvrements pour effectuer, s'il y a lieu, des travaux d'entretien et de dépannage.
- Remettre en place les portes, panneaux, recouvrements ou dispositifs de protection à la fin des travaux d'entretien et avant de mettre le moteur en marche.



DES PIÈCES CHAUDES peuvent provoquer des brûlures graves.

- Ne pas toucher de pièces chaudes du compresseur ou du circuit d'air.
- Prévoir une période de refroidissement avant d'intervenir sur l'équipement.
- Ne pas toucher aux pièces chaudes, utiliser les outils recommandés et porter des gants de soudage et des vêtements épais pour éviter les brûlures.

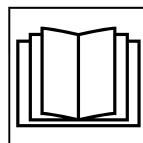

LIRE LES INSTRUCTIONS.

- Lire et appliquer les instructions sur les étiquettes et le Mode d'emploi avant l'installation, l'utilisation ou l'entretien de l'appareil. Lire les informations de sécurité au début du manuel et dans chaque section.
- N'utiliser que des pièces de remplacement provenant du fabricant.
- Effectuer l'installation, l'entretien et toute intervention selon les manuels d'utilisateurs, les normes nationales, provinciales et de l'industrie, ainsi que les codes municipaux.

2-5. Symboles de dangers supplémentaires en relation avec l'installation, le fonctionnement et la maintenance



Risque D'INCENDIE OU D'EXPLOSION.

- Ne pas placer l'appareil sur, au-dessus ou à proximité de surfaces inflammables.
- Ne pas installer l'appareil à proximité de produits inflammables
- Ne pas surcharger l'installation électrique – s'assurer que l'alimentation est correctement dimensionnée et protégée avant de mettre l'appareil en service.

- Utilisez les procédures correctes et des équipements d'une capacité appropriée pour soulever et supporter l'appareil.
- En utilisant des fourches de levage pour déplacer l'unité, s'assurer que les fourches sont suffisamment longues pour dépasser du côté opposé de l'appareil.
- Tenir l'équipement (câbles et cordons) à distance des véhicules mobiles lors de toute opération en hauteur.
- Suivre les consignes du Manuel des applications pour l'équation de levage NIOSH révisée (Publication No 94-110) lors du levage manuel de pièces ou équipements lourds.



LA CHUTE DE L'ÉQUIPEMENT peut provoquer des blessures.

- Utiliser seulement l'anneau de levage pour soulever l'appareil et des accessoires correctement installés, non pas les bouteilles de gaz. Ne pas dépasser les capacités maximales de l'anneau de levage (voir Spécifications).

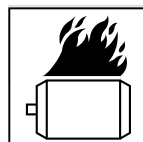

LE SURCHAUFFEMENT peut endommager le moteur électrique.

- Arrêter ou déconnecter l'équipement avant de démarrer ou d'arrêter le moteur.
- Ne pas laisser tourner le moteur trop lentement sous risque d'endommager le moteur électrique à cause d'une tension et d'une fréquence trop faibles.

- Utiliser uniquement des équipements adéquats pour un fonctionnement avec une alimentation de 50/60 ou de 60 Hz.

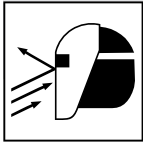

LES ÉTINCELLES PROJÉTÉES peuvent provoquer des blessures.

- Porter un écran facial pour protéger le visage et les yeux.
- Affûter l'électrode au tungstène uniquement à la meuleuse dotée de protecteurs. Cette manœuvre est à exécuter dans un endroit sûr lorsque l'on porte l'équipement homologué de protection du visage, des mains et du corps.
- Les étincelles risquent de causer un incendie - éloigner toute substance inflammable.



Les PIÈCES MOBILES peuvent causer des blessures.

- Ne pas s'approcher des organes mobiles.
- Ne pas s'approcher des points de coincement tels que des rouleaux de commande.



LA SORTIE DE RECHARGE et L'EXPLOSION DE LA BATTERIE peuvent provoquer des blessures.

La recharge de batterie n'existe pas sur tous les modèles.

- Toujours porter une protection faciale, des gants en caoutchouc et vêtements de protection lors d'une intervention sur la batterie.
- Arrêter le moteur avant de débrancher ou de brancher des câbles de batterie, des câbles de chargeur de batterie (le cas échéant) ou de batterie d'entretien.
- Éviter de provoquer des étincelles avec les outils en travaillant sur la batterie.
- Ne pas utiliser l'appareil de soudage pour charger des batteries ou faire démarrer des véhicules à l'aide de câbles de démarrage, sauf si l'appareil dispose d'une fonctionnalité de charge de batterie destinée à cet usage.
- Observer la polarité correcte (+ et -) sur les batteries.
- Débrancher le câble négatif (-) en premier lieu. Le rebrancher en dernier lieu.
- Les sources d'étincelles, flammes nues, cigarettes et autres sources d'inflammation doivent être maintenues à l'écart des batteries. Ces dernières produisent des gaz explosifs en fonctionnement normal et en cours de charge.
- Suivre les instructions du fabricant de la batterie lors d'opérations sur une batterie ou à proximité de celle-ci. Voir le manuel de service de batterie (indiqué dans Normes de sécurité) pour plus d'informations.
- Les opérations de charge de batterie ne doivent être effectuées que par des personnes qualifiées.
- Pour enlever la batterie d'un véhicule pour la recharge, débrancher tout d'abord le câble négatif (-) et le rebrancher en dernier lieu. Pour éviter un arc, s'assurer que tous les accessoires sont débranchés.
- Ne charger que des batteries plomb-acide. Ne pas utiliser le chargeur de batterie pour alimenter un autre circuit électrique basse tension ou pour charger des batteries sèches.
- Ne pas charger une batterie gelée.
- Ne pas utiliser de câbles de charge endommagés.
- Ne pas charger des batteries dans un espace fermé ou en l'absence d'une ventilation.
- Ne pas charger une batterie dont les bornes sont desserrées ou présentant une détérioration comme par exemple un boîtier ou un couvercle fissuré.
- Avant de charger une batterie, sélectionner la tension de charge correspondant à la tension de la batterie.

- Régler les commandes de charge de batterie sur la position d'arrêt avant de brancher la batterie. Veiller à ce que les pinces de charge ne se touchent pas.
- Ranger les câbles de charge à distance du capot, des portes et des pièces mobiles du véhicule.



LES LIQUIDES PRESSURISÉS peuvent blesser ou tuer.

- Les composants du système d'alimentation peuvent contenir du carburant sous pression élevée.
- Avant d'intervenir sur le système d'alimentation de carburant, arrêter le moteur pour dépressuriser le système.
- En cas d'injection de tout liquide sous la peau ou dans le corps, solliciter une aide médicale sur le champ.



LES FILS DE SOUDAGE peuvent provoquer des blessures.

- Ne pas appuyer sur la gachette avant d'en avoir reçu l'instruction.
- Ne pas diriger le pistolet vers soi, d'autres personnes ou toute pièce mécanique en engageant le fil de soudage.

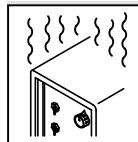

L'EMPLOI EXCESSIF peut SURCHAUFFER L'ÉQUIPEMENT.

- Laisser l'équipement refroidir ; respecter le facteur de marche nominal.
- Réduire le courant ou le cycle opératoire avant de recommencer le soudage.
- Ne pas obstruer les passages d'air du poste.

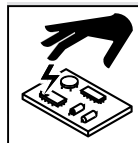

LES CHARGES ÉLECTROSTATIQUES peuvent endommager les circuits imprimés.

- Établir la connexion avec la barrette de terre AVANT de manipuler des cartes ou des pièces.
- Utiliser des pochettes et des boîtes antistatiques pour stocker, déplacer ou expédier des cartes de circuits imprimés.

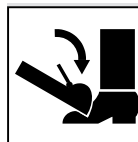

UNE REMORQUE QUI BASCULE peut provoquer des blessures.

- Utiliser les supports de la remorque ou des blocs pour soutenir le poids.
- Installer convenablement le poste sur la remorque comme indiqué dans le manuel s'y rapportant.

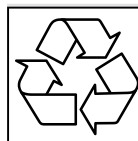

RECYCLER.

- Recycler ou éliminer les liquides usagés d'une manière respectueuse de l'environnement. Cela est particulièrement vrai pour les fluides du moteur tels que l'huile de vidange et le liquide de refroidissement usagés ; ceci est également important pour le liquide de refroidissement provenant des systèmes de refroidissement de la torche/du pistolet.
- Contactez votre bureau de recyclage local ou votre distributeur local pour obtenir des informations sur la manière de mettre au rebut les pièces et l'équipement d'une manière respectueuse de l'environnement.

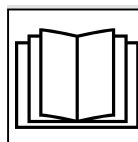

LIRE LES INSTRUCTIONS.

- Lire et appliquer les instructions sur les étiquettes et le Mode d'emploi avant l'installation, l'utilisation ou l'entretien de l'appareil. Lire les informations de sécurité au début du manuel et dans chaque section.
- N'utiliser que des pièces de remplacement provenant du fabricant.

- Effectuer l'installation, l'entretien et toute intervention selon les manuels d'utilisateurs, les normes nationales, provinciales et de l'industrie, ainsi que les codes municipaux.

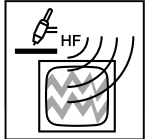

LE RAYONNEMENT HAUTE FRÉQUENCE (H.F.) risque de provoquer des interférences.

- Le rayonnement haute fréquence (H.F.) peut provoquer des interférences avec les équipements de radio-navigation et de communication, les services de sécurité et les ordinateurs.
- Demander seulement à des personnes qualifiées familiarisées avec des équipements électroniques de faire fonctionner l'installation.
- L'utilisateur est tenu de faire corriger rapidement par un électricien qualifié les interférences résultant de l'installation.
- Si le FCC signale des interférences, arrêter immédiatement l'appareil.
- Effectuer régulièrement le contrôle et l'entretien de l'installation.
- Maintenir soigneusement fermés les portes et les panneaux des sources de haute fréquence, maintenir les éclateurs à une distance correcte et utiliser une terre et un blindage pour réduire les interférences éventuelles.

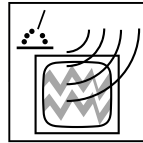

LE SOUDAGE À L'ARC risque de provoquer des interférences.

- L'énergie électromagnétique risque de provoquer des interférences pour l'équipement électronique sensible tel que les ordinateurs et l'équipement commandé par ordinateur tel que les robots.

- Veiller à ce que tout l'équipement de la zone de soudage soit compatible électromagnétiquement.
- Pour réduire la possibilité d'interférence, maintenir les câbles de soudage aussi courts que possible, les grouper, et les poser aussi bas que possible (ex. par terre).
- Veiller à souder à une distance de 100 mètres de tout équipement électronique sensible.
- Veiller à ce que ce poste de soudage soit posé et mis à la terre conformément à ce mode d'emploi.
- En cas d'interférences après avoir pris les mesures précédentes, il incombe à l'utilisateur de prendre des mesures supplémentaires telles que le déplacement du poste, l'utilisation de câbles blindés, l'utilisation de filtres de ligne ou la pose de protecteurs dans la zone de travail.

2-6. Proposition californienne 65 Avertissements

⚠ AVERTISSEMENT – ce produit peut vous exposer à des produits chimiques tels que le plomb, reconnus par l'État de Californie comme cancérigènes et sources de malformations ou d'autres troubles de la reproduction.

Pour plus d'informations, consulter www.P65Warnings.ca.gov.

Pour les moteurs diesel :

⚠ AVERTISSEMENT – les gaz d'échappement de moteurs diesel vous exposent à des produits chimiques, reconnus par l'État de Californie comme cancérigènes et sources de malformations ou d'autres troubles de la reproduction.

- Toujours démarrer et faire tourner le moteur dans une zone bien aérée.
- Si la zone est fermée, diriger l'échappement vers l'extérieur.
- Ne pas modifier ni altérer le système d'échappement.
- Ne pas faire tourner le moteur au ralenti, sauf si nécessaire.

Pour plus d'informations, consulter www.P65Warnings.ca.gov/diesel.

2-7. Principales normes de sécurité

Safety in Welding, Cutting, and Allied Processes, American Welding Society standard ANSI Standard Z49.1. Website: <http://www.aws.org>.

Safe Practices for the Preparation of Containers and Piping for Welding and Cutting, American Welding Society Standard AWS F4.1. Website: <http://www.aws.org>.

National Electrical Code, NFPA Standard 70 from National Fire Protection Association. Website: www.nfpa.org.

Safe Handling of Compressed Gases in Cylinders, CGA Pamphlet P-1 from Compressed Gas Association. Website: www.cganet.com.

Safety in Welding, Cutting, and Allied Processes, CSA Standard W117.2 from Canadian Standards Association. Website: www.csa-group.org.

Battery Chargers, CSA Standard C22.2 NO 107.2-01 from Canadian Standards Association. Website: www.csagroup.org.

Safe Practice For Occupational And Educational Eye And Face Protection, ANSI Standard Z87.1, from American National Standards Institute. Website: www.ansi.org.

Standard for Fire Prevention During Welding, Cutting, and Other Hot Work, NFPA Standard 51B from National Fire Protection Association. Website: www.nfpa.org.

OSHA, Occupational Safety and Health Standards for General Industry, Title 29, Code of Federal Regulations (CFR), Part 1910.177 Subpart N, Part 1910 Subpart Q, and Part 1926, Subpart J. Website: www.osha.gov.

OSHA *Important Note Regarding the ACGIH TLV, Policy Statement on the Uses of TLVs and BEIs*. Website: www.osha.gov.

Portable Generator Hazards Safety Alert from U.S. Consumer Product Safety Commission (CPSC). Website: www.cpsc.gov.

Applications Manual for the Revised NIOSH Lifting Equation from the National Institute for Occupational Safety and Health (NIOSH). Website: www.cdc.gov/NIOSH.

For Standards regulating hydraulic systems, contact the National Fluid Power Association. Website: www.nfpa.com.

Battery Service Manual from the Battery Council International. Website: www.batterycouncil.org.

ROM_fre 2022-01

2-8. Informations relatives aux CEM

Le courant électrique qui traverse tout conducteur génère des champs électromagnétiques (CEM) à certains endroits. Le courant issu d'un soudage à l'arc (et de procédés connexes, y compris le soudage par points, le gougeage, le découpage plasma et les opérations

de chauffage par induction) crée un champ électromagnétique (CEM) autour du circuit de soudage. Les champs électromagnétiques produits peuvent causer interférence à certains implants médicaux, p. ex. les stimulateurs cardiaques. Des mesures de protection pour

les porteurs d'implants médicaux doivent être prises: par exemple, des restrictions d'accès pour les passants ou une évaluation individuelle des risques pour les soudeurs. Tous les soudeurs doivent appliquer les procédures suivantes pour minimiser l'exposition aux CEM provenant du circuit de soudage:

1. Rassembler les câbles en les torsadant ou en les attachant avec du ruban adhésif ou avec une housse.
2. Ne pas se tenir au milieu des câbles de soudage. Disposer les câbles d'un côté et à distance de l'opérateur.
3. Ne pas courber et ne pas entourer les câbles autour de votre corps.
4. Maintenir la tête et le torse aussi loin que possible du matériel du circuit de soudage.

5. Connecter la pince sur la pièce aussi près que possible de la soudure.
6. Ne pas travailler à proximité d'une source de soudage, ni s'asseoir ou se pencher dessus.
7. Ne pas souder tout en portant la source de soudage ou le dévidoir.









En ce qui concerne les implants médicaux :





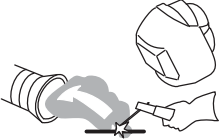

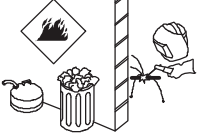
Les porteurs d'implants doivent d'abord consulter leur médecin avant de s'approcher des opérations de soudage à l'arc, de soudage par points, de gougeage, du coupage plasma ou de chauffage par induction. Si le médecin approuve, il est recommandé de suivre les procédures précédentes.

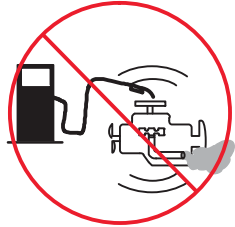
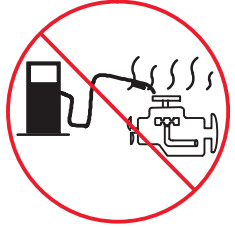
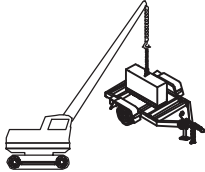

SECTION 3 – DEFINITIONS

3-1. Additional Safety Symbol Definitions

Some symbols are found only on CE products.



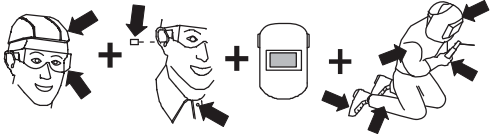
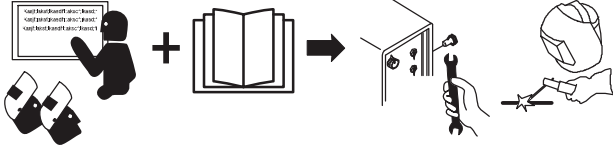
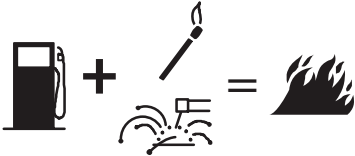
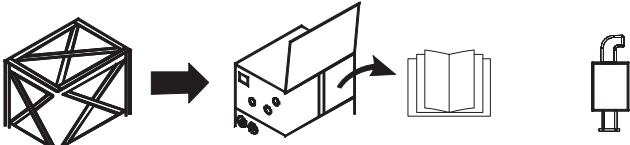

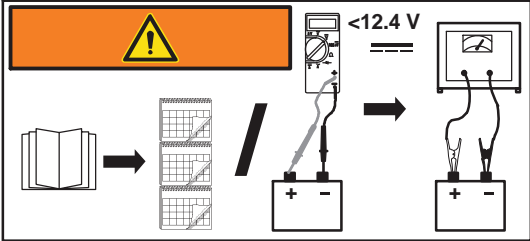
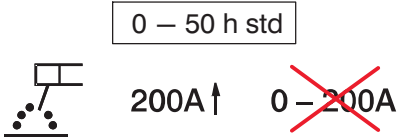
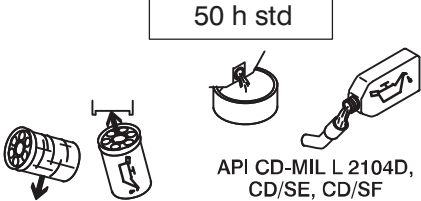

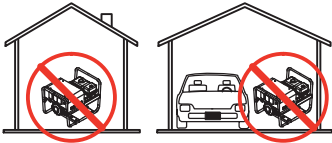
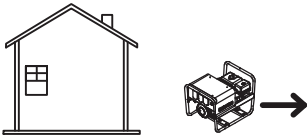





	<p>Warning! Watch Out! There are possible hazards as shown by the symbols.</p>
	<p>Wear dry insulating gloves. Do not touch electrode with bare hand. Do not wear wet or damaged gloves.</p>
	<p>Protect yourself from electric shock by insulating yourself from work and ground.</p>
	<p>Keep your head out of the fumes.</p>
	<p>Use forced ventilation or local exhaust to remove the fumes.</p>
	<p>Use ventilating fan to remove fumes.</p>
	<p>Keep flammables away from welding. Do not weld near flammables.</p>
	<p>Welding sparks can cause fires. Have a fire extinguisher nearby, and have a watchperson ready to use it.</p>
	<p>Do not weld on drums or any closed containers.</p>













	<p>Do not remove or paint over (cover) the label.</p>
	<p>Do not work on unit if engine is running. Stop engine first.</p>
	<p>Do not smoke while fueling or if near fuel.</p>
	<p>Stop engine before fueling.</p>
	<p>Do not fuel a hot engine.</p>
	<p>Use lift eye to lift unit and properly installed accessories only, not gas cylinders. Do not exceed maximum lift eye rating (see Specifications).</p>
	<p>Do not spray water on electrical parts, including Engine Control Unit (ECU).</p>
	<p>Do not use ether or other starting fluids. Using starting fluids voids warranty. See engine Owner's Manual.</p>
	<p>Hot muffler, exhaust pipe, and external surfaces can burn.</p>













	<p>Welding, cutting, drilling, or grinding on base can cause fire or explosion.</p>
	<p>Wear hat and safety glasses. Use ear protection and button shirt collar. Use welding helmet with correct shade of filter. Wear complete body protection made from leather or flame-resistant clothing (FRC). Body protection includes oil-free clothing such as leather gloves, heavy shirt, cuffless trousers, high shoes, and a cap.</p>
	<p>Become trained and read the instructions before working on the machine or welding.</p>
	<p>Engine fuel plus flames or sparks can cause fire.</p>
	<p>Remove unit from shipping crate. Remove Owner's Manual from unit. Follow instructions to install muffler.</p>
	<p>Read Owner's Manual. Read labels on unit.</p>
	<p>Read Owner's Manual for battery maintenance information.</p>
	<p>During the first 50 hours of operation keep welding load above 200 amperes. Do not weld below 200 amperes of output.</p>
	<p>After the first 50 hours of operation, change the engine oil and filter.</p>









	<p>Never use generator inside a home or garage, even if doors and windows are open.</p>
	<p>Only use generator outside and far away from windows, doors, and vents.</p>









3-2. Miscellaneous Symbols And Definitions









	Stop Engine
	Fuel
	Engine
	Positive
	Off
	Single Phase
	Duty Cycle
	Rated Idle Speed
	Hertz
	Run (Fast)
	Battery (Engine)
	Spark Arrestor
	Engine-Driven, Three-Phase Alternator With Rectifier
	Negative

	On
	Internal Protection Rating
	Three Phase
	Hours
	Rated No Load Voltage (OCV)
	Rated No Load Speed
	Suitable For Welding In An Environment With Increased Risk Of Electric Shock
	Idle (Slow)
	Air Cleaner
	Engine Belt
	Temperature
	Output
	Read Operator's Manual

	Direct Current
	Conventional Load Voltage
	Maximum Power Consumption
	Start Engine
	Engine Oil
	Protective Earth (Ground)
	Remote
	Alternating Current
	Do Not Switch While Welding
	Rated Load Speed
	Rated Welding Current
	Circuit Protection
	Amperage

	Voltage
	Percent
	Glow Plug
	Arc Control
	USB
	Push Button
	Press Or Turn Button
	Shielded Metal Arc Welding (SMAW)
	Gas Metal Arc Welding (GMAW)

	Gas Tungsten Arc Welding (GTAW) / Tungsten Inert Gas Welding (TIG)
	Tungsten Inert Gas (TIG) Lift Arc
	Flux Cored Arc Welding (FCAW)
	Air Carbon Arc Cutting (CAC-A)
	Air Filter
	Seconds
	Engine Coolant
	Engine
	Air Compressor

	Increase
	Current
	Previous
	Menu
	Cancel Function
	View
	Enter
	Diagnostics
	Next

SECTION 4 – SPECIFICATIONS

4-1. Serial Number And Rating Label Location

The serial number and rating information for this product is located on the right side. Use rating label to determine input power requirements and/or rated output. For future reference, write serial number in space provided on back cover of this manual.

4-2. Software Licensing Agreement

The End User License Agreement and any third-party notices and terms and conditions pertaining to third-party software can be found at <https://www.millerwelds.com/eula> and are incorporated by reference herein.

4-3. Information About Default Weld Parameters And Settings

NOTICE – Each welding application is unique. Although certain Miller Electric products are designed to determine and default to certain typical welding parameters and settings based upon specific and relatively limited application variables input by the end user, such default settings are for reference purposes only; and final weld results can be affected by other variables and application-specific circumstances. The appropriateness of all parameters and settings should be evaluated and modified by the end user as necessary based upon application-specific requirements. The end user is solely responsible for selection and coordination of appropriate equipment, adoption or adjustment of default weld parameters and settings, and ultimate quality and durability of all resultant welds. Miller Electric expressly disclaims any and all implied warranties including any implied warranty of fitness for a particular purpose.

4-4. Weld, Power, And Engine Specifications

This equipment will deliver rated output at an ambient air temperature up to 104°F (40°C).

Model	Welding Mode	Weld Output Range	Rated Output Dual Operator (Each Side)	Rated Output Single Operator	Maximum Open-Circuit Voltage (Nominal)
Big Blue 800 Duo Air Pak Big Blue 800 Duo Pro	CC/DC	20-400 A Dual Operator 40-800 A Single Operator	Stick: 400 A, 36 VDC, 100% Duty Cycle TIG: 400 A, 26 VDC, 100% Duty Cycle	Stick: 800 A, 38 VDC, 100% Duty Cycle TIG: 800 A, 38 VDC, 100% Duty Cycle	92
	CV/DC	15-50 V	400 A, 34 VDC, 100% Duty Cycle	800 A, 38 VDC, 100% Duty Cycle	92
Big Blue 600 Air Pak	CC/DC	20-600 A	— —	600 A, 44 VDC, 60% Duty Cycle 575 A, 43 VDC, 100% Duty Cycle	92
	CV/DC	15-50 V			92

Generator Power Rating	Engine	Fuel Tank Capacity
Independent of Weld Output Single-Phase, 4 kVA/kW, 34/17 A, 120/240 V AC, 50/60 Hz 3-Phase Generator (In Addition To Standard 4 kVA/kW Generator Power) Single-Phase/Three-Phase, 12/20 kVA/kW, 50/48 A, 120/240 VAC, 50/60 Hz	Deutz TD2.9L4 Liquid-Cooled, Four-Cylinder, Turbo-Charged 65.7 HP Diesel Engine, Tier 4 Final Compliant	25 gal (95 L)

4-5. Air Compressor Specifications (Air Pak Models)

Compressor Model And Type	Air Output At Effective Working Pressure	Factory Pressure Setting	Safety Relief Valve Rating
Ingersoll Rand CE55 G Rotary Screw	60 scfm (1.7 m ³ min ⁻¹), 100 psi (690 kPa), 100% Duty Cycle	125 psi (862 kPa)	150 psi (1034 kPa)

4-6. Environmental Specifications

A. IP Rating

IP Rating
IP23S
This equipment is designed for outdoor use. It may be stored, but is not intended to be used for welding outside during precipitation unless sheltered.

B. Temperature Specifications

Operating Temperature Range*	Storage/Transportation Temperature Range
-40 to 104°F (-40 to 40°C)	-40 to 131°F (-40 to 55°C)

*Output is derated at temperatures above 104°F (40°C).

4-7. Dimensions, Weights, And Operating Angles

Dimensions	
Height	53.75 in. (1365 mm) to top of exhaust
Width	28.5 in. (724 mm) (mtg. brackets turned in) 31.06 in. (789 mm) (mtg. brackets turned out)
Depth	69.5 in. (1765 mm)
A	69.5 in. (1765 mm)
B	57.9 in. (1470 mm)
C	52.88 in. (1343 mm)
D	5.02 in. (128 mm)
E	27.85 in. (707 mm)
F	1 in. (25 mm)
G	29.81 in. (757 mm)
H	9/16 in. (14 mm) Dia. 4 Holes
Weight	
Big Blue 800 Duo Air Pak	No fuel: 2095 lb (950 kg) W/fuel: 2275 lb (1032 kg)
Big Blue 600 Air Pak	No fuel: 2040 lb (925 kg) W/fuel: 2220 lb (1007 kg)
Big Blue 800 Duo Pro	No fuel: 1869 lb (848 kg) W/fuel: 2034 lb (923 kg)
Lifting Eye Weight Rating: 2500 lb (1134 kg) Maximum	

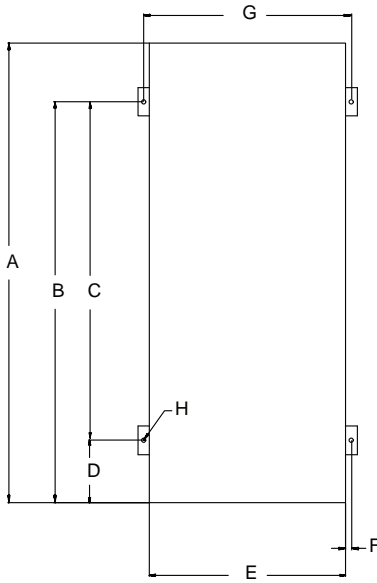

802 161-A



⚠ Do not exceed tilt angles or engine could be damaged or unit could tip.

⚠ Do not move or operate unit where it could tip.

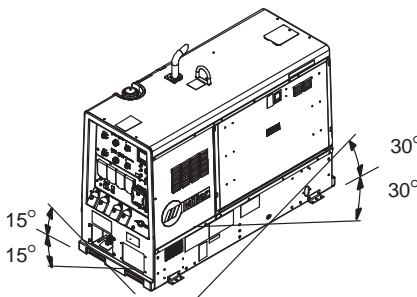



15°
15°
30°
30°

907752

4-8. Duty Cycle And Overheating



Continuous Welding

Duty Cycle is percentage of 10 minutes that unit can weld at rated load without overheating.

- ☞ *Dual operator units are rated for welding at 400 amperes continuously in dual operator mode or 800 amperes continuously in single operator mode.*
- ☞ *Single operator units are rated for welding at 575 amperes continuously.*

NOTICE – Exceeding duty cycle can damage unit and void warranty.

4-9. Volt-Ampere Curves (800 Models)

The volt-ampere curves show the minimum and maximum voltage and amperage output capabilities of the welder/generator. Curves of all other settings fall between the curves shown.

Stick

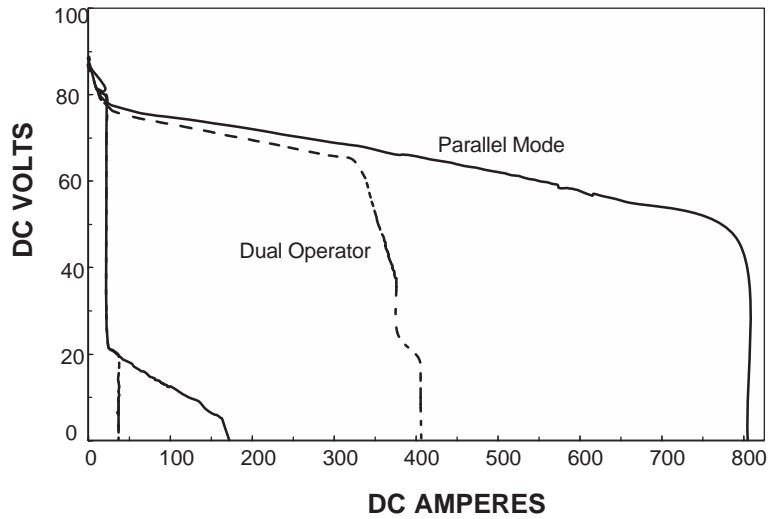

TIG

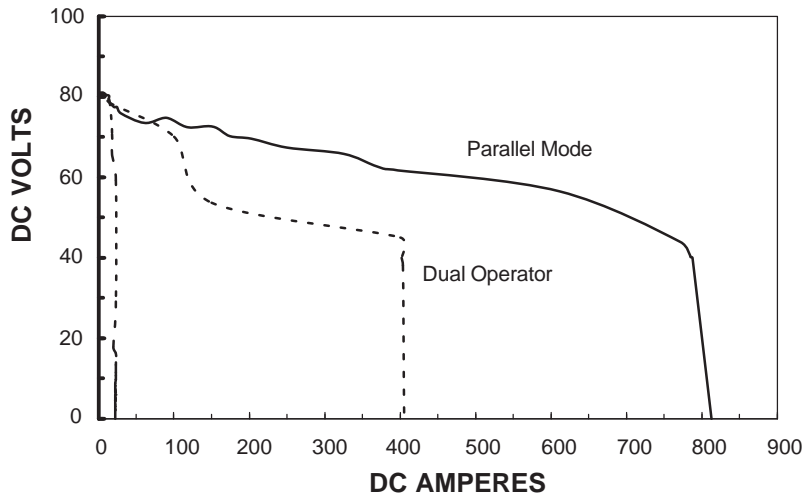

MIG

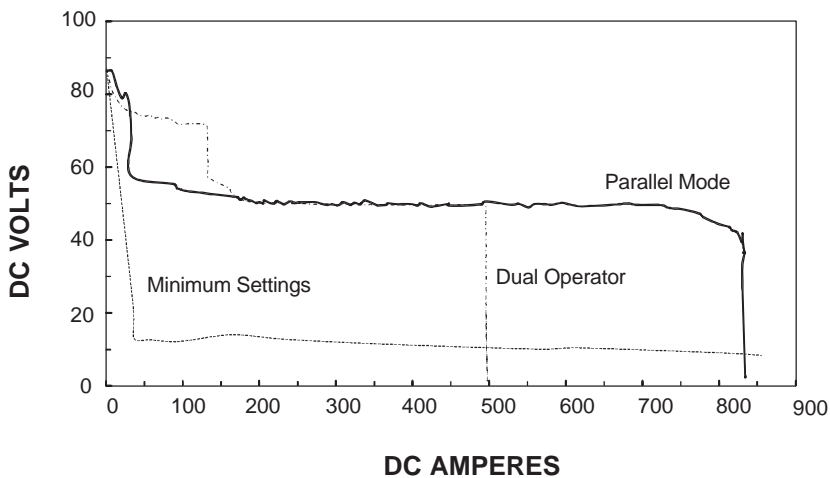

4-10. Volt-Ampere Curves (600 Models)

Stick

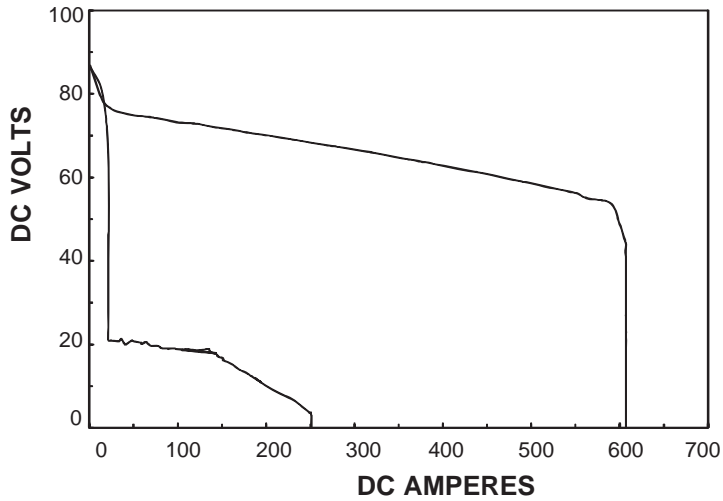

The volt-ampere curves show the minimum and maximum voltage and amperage output capabilities of the welder/generator. Curves of all other settings fall between the curves shown.

TIG

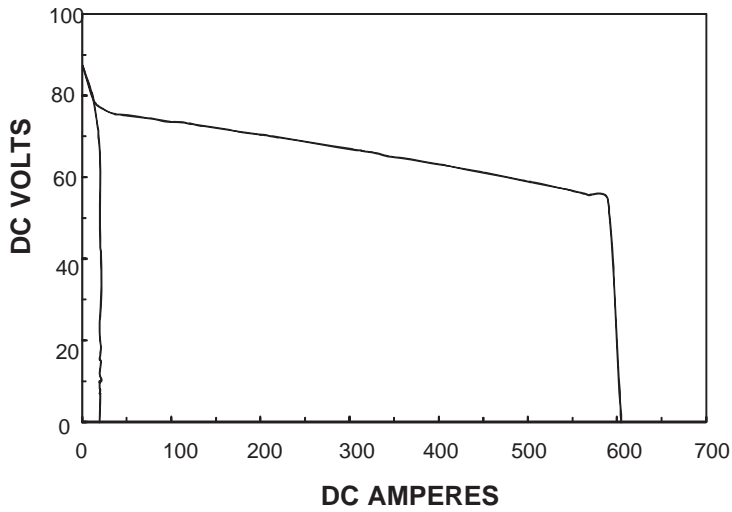

MIG

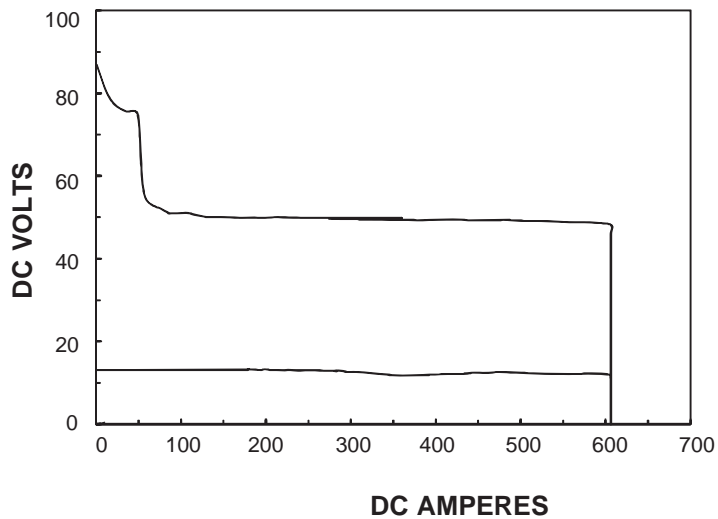

4-11. Generator Power Curves

The AC power curve shows the generator power in amperes.

Single Phase 4 kW

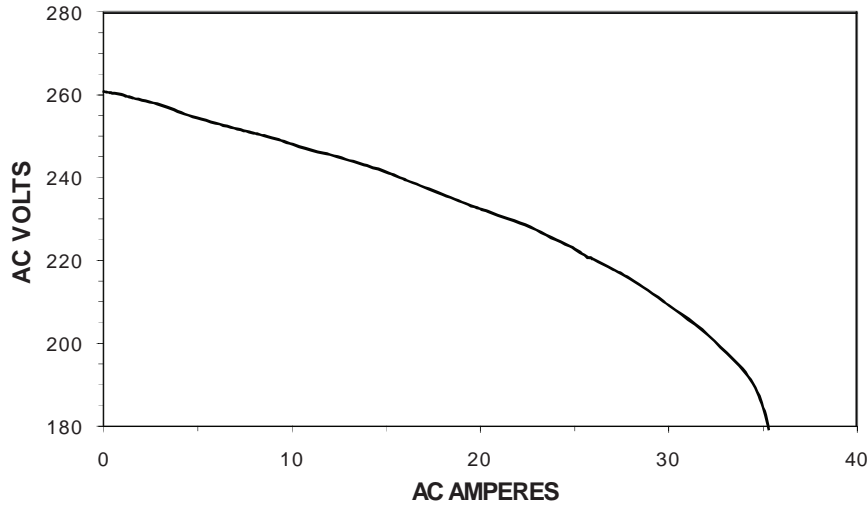

Single Phase 12 kW

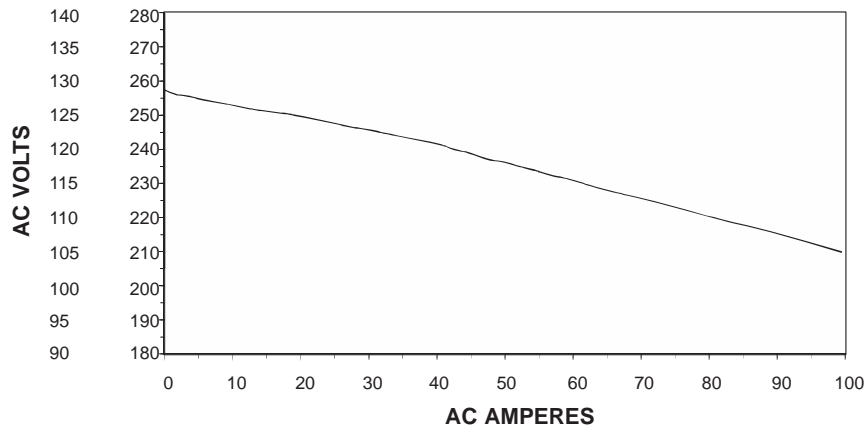

Three Phase 20 kW

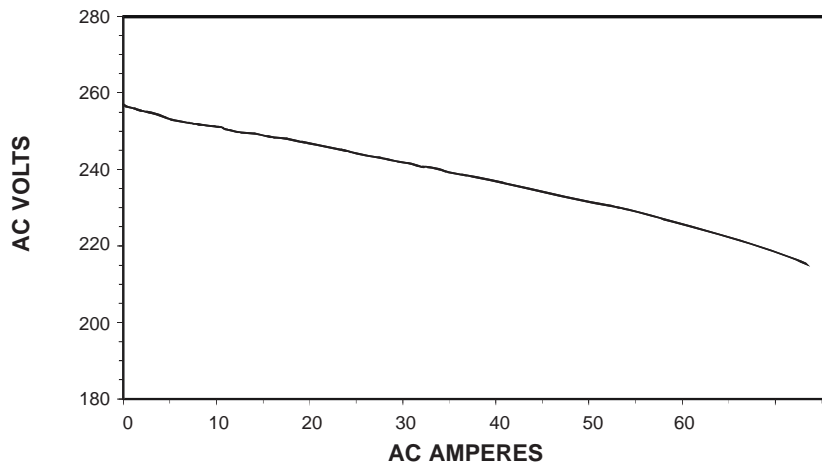

4-12. Fuel Consumption

800 Models

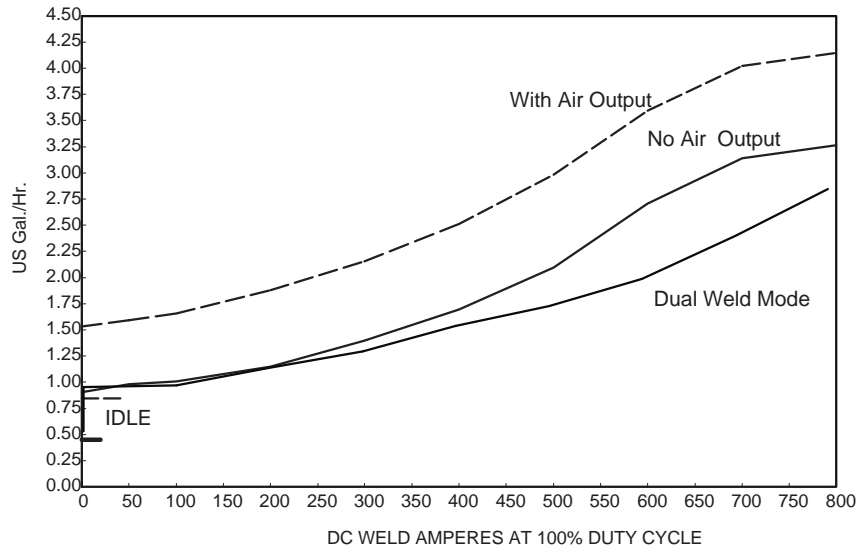

The curve shows typical fuel use under weld or power loads.

600 Models

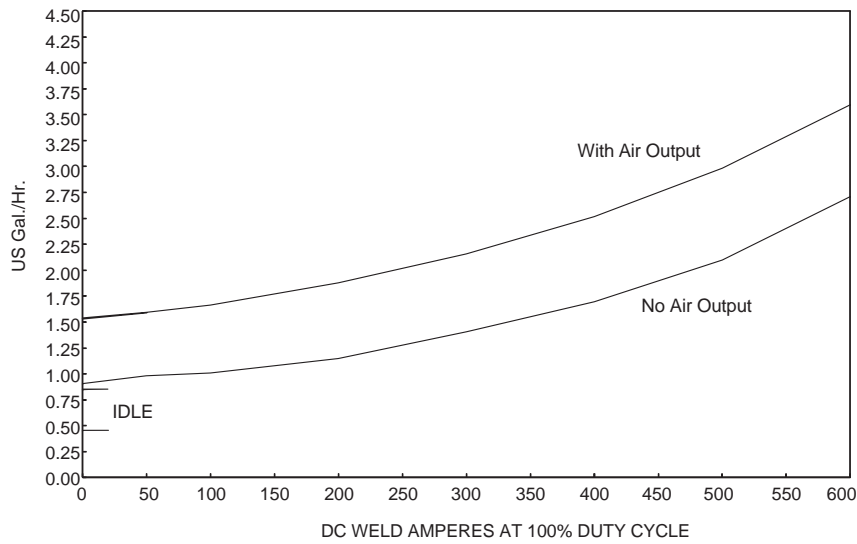

SECTION 5 – INSTALLATION

5-1. Installing Welder/Generator

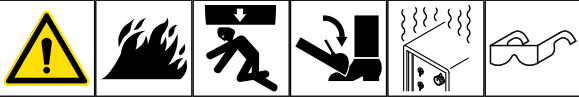

Movement And Airflow Clearance

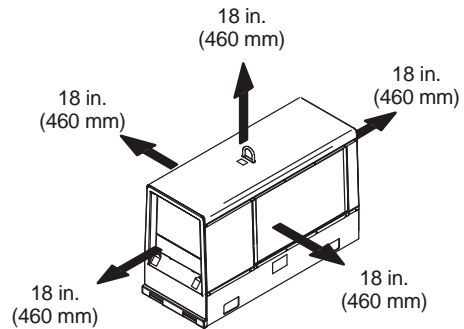
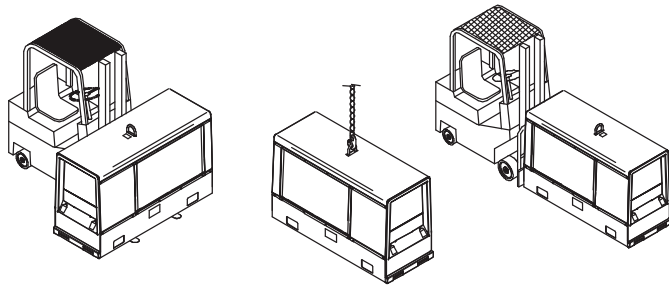

Location/Mounting

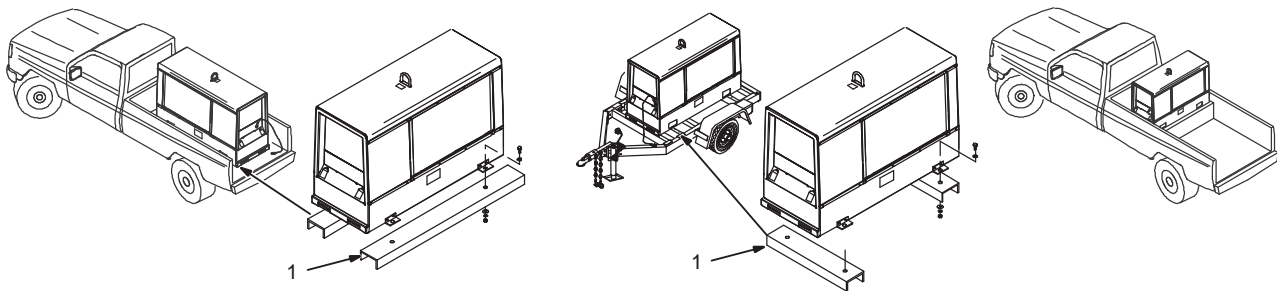
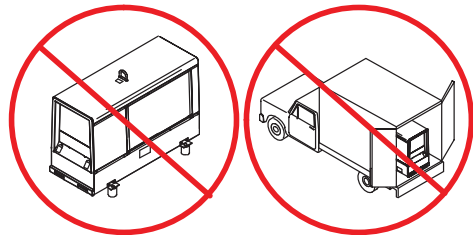
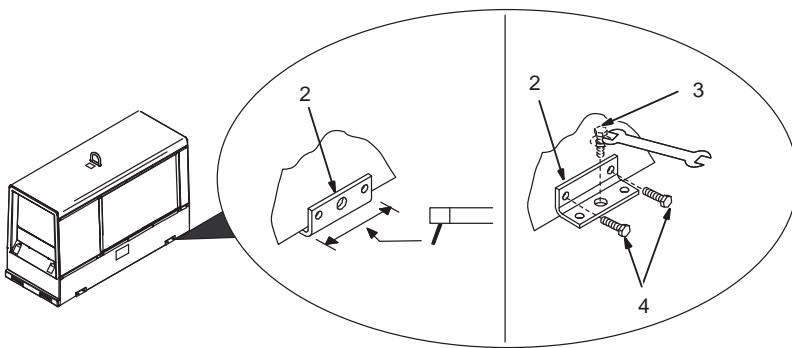

9/16 in.

Go to MillerWelds.com for more information on truck installations.

Movement

Do not move or operate unit where it could tip.

See Specifications for lifting eye rating.

Airflow Clearance

NOTICE – Do not install unit where air flow is restricted or engine may overheat.

Location/Mounting

Always securely fasten welding generator onto transport vehicle or trailer and comply with all DOT and other applicable codes.

Do not weld on base. Welding on base can cause fuel tank fire or explosion. Weld only on the four mounting brackets or bolt unit down.

NOTICE – Do not mount unit by supporting the base only at the four mounting brackets. Use cross-supports to adequately support unit and prevent damage to base.

- 1 Cross-Supports
- 2 Mounting Brackets (Supplied)

Mount unit on flat surface or use cross-supports to support base. Secure unit with mounting brackets.

3 1/2 in. Bolt And Washer (Minimum - Not Supplied)

4 3/8-16 x 1 in. Screws (Supplied)

To Bolt Unit In Place:

Remove hardware securing the four mounting brackets to the base. Reverse brackets and reattach to base with original hardware.

Mount unit to truck or trailer with 1/2 in. (12 mm) or larger hardware (not supplied).

To Weld Unit In Place:

Weld unit to truck or trailer only at the four mounting brackets.

5-2. Grounding Generator to Truck or Trailer Frame

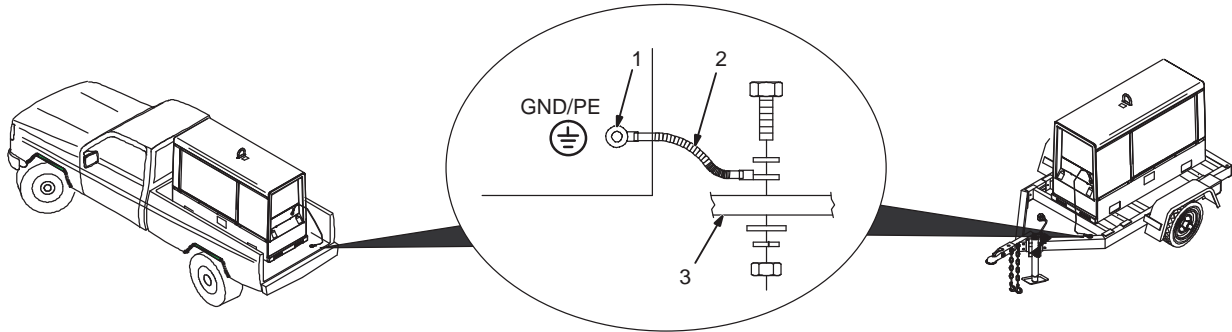

⚠ Always ground generator frame to vehicle frame to prevent electric shock and static electricity hazards.

⚠ Also see AWS Safety & Health Fact Sheet No. 29, Grounding of Portable And Vehicle Mounted Welding Generators.

⚠ Bed liners, shipping skids, and some running gear insulate the welding generator from the vehicle frame. Always connect a ground wire from the generator equipment grounding terminal to bare metal on the vehicle frame as shown.

1 Equipment Grounding Terminal (On Front Panel)

2 Grounding Cable (Not Supplied)

3 Metal Vehicle Frame

Connect cable from equipment ground terminal to metal vehicle frame. Use #8 AWG or larger insulated copper wire.

Electrically bond generator frame to vehicle frame by metal-to-metal contact.

5-3. Installing Exhaust Pipe

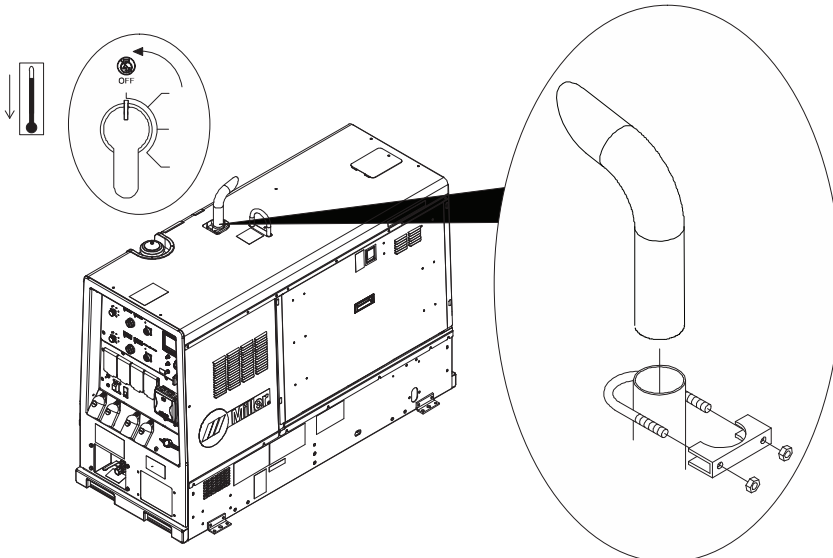

⚠ Stop engine and let cool.

Point exhaust pipe in desired direction but always away from front panel and direction of travel.

907752 / Exhaust3

1/2 in.

5-4. Connecting The Battery

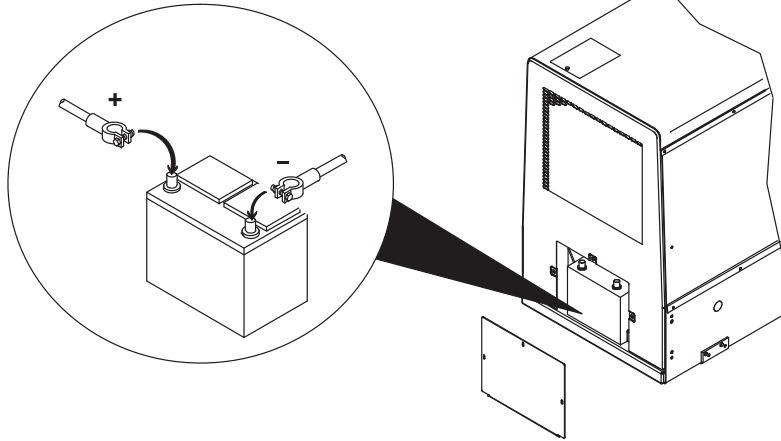
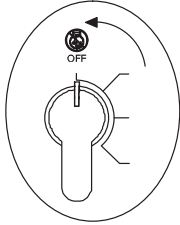
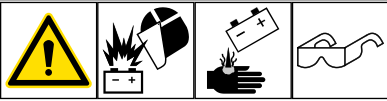

 1/2 in.

NOTICE – Lead acid batteries discharge when stored in any temperature. Units that are stored should have the battery recharged every three months and before being put into service. To preserve optimum battery performance and life, recharge battery in storage when the open-circuit voltage drops to 12.4 volts DC when measured across the battery terminals.

⚠ Connect negative (-) cable last.

NOTICE – Wait two minutes after engine shutdown before disconnecting battery or engine controller may be damaged.

Battery is most easily accessed through the rear panel. Remove battery access panel from rear panel. Connect battery, negative cable last. Reinstall battery access panel.

- Do not allow the battery cables to touch opposing terminals. When connecting the battery cables attach the positive (+) cable to the positive (+) battery terminal first, followed by negative (-) cable to negative (-) battery terminal.

- Never start the engine when the cables are loose or poorly connected to the battery terminals.
- Never disconnect the battery while the engine is running.
- Never use a quick battery charger to start the engine.
- Do not charge battery with Engine Control switch On.
- Always disconnect the negative (-) battery cable before charging battery.

5-5. Using The Battery Disconnect Switch

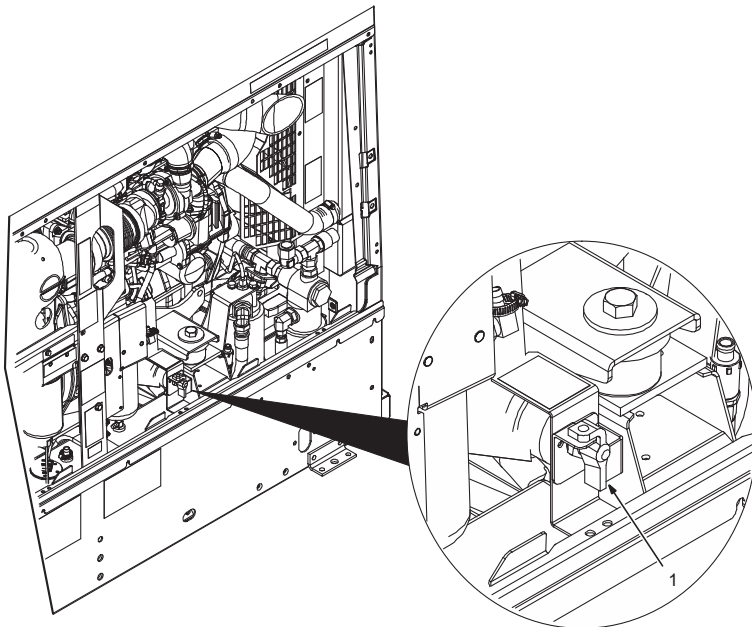

⚠ Stop engine.

1 Battery Disconnect Switch

The battery disconnect switch disconnects battery voltage from the circuit. When the switch is turned Off, the front panel controls do not work.

To run unit, turn switch to On position. To prevent unit from running, turn switch to Off position.

The switch may be locked using a customer-supplied padlock.

5-6. Engine Prestart Checks

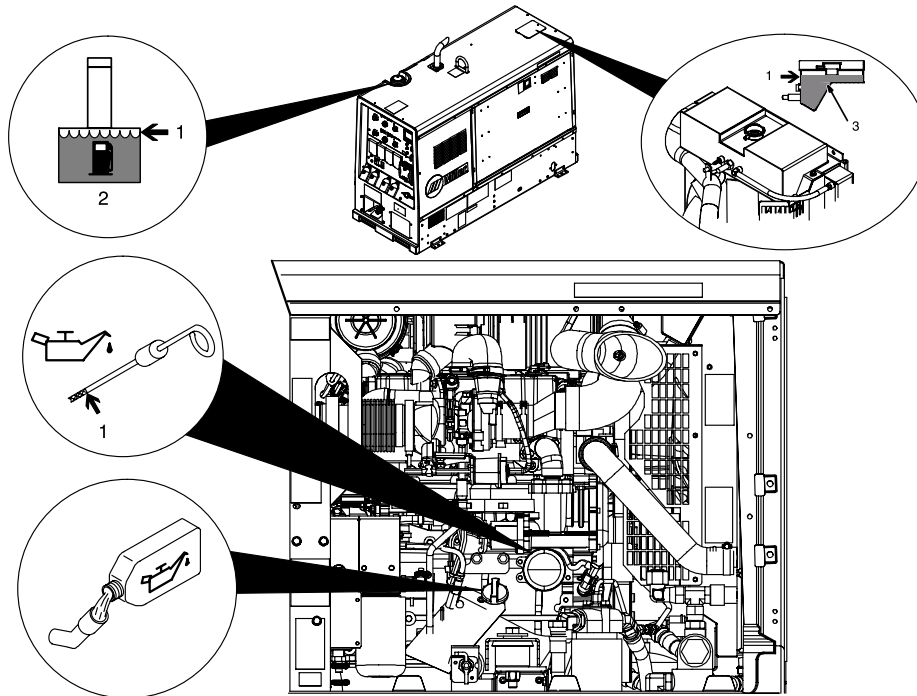

907752

☞ Check all engine fluids daily.

☞ Automatic warning and shutdown indicators are displayed on the Engine Display. See Section 13 for engine display information.

Engine must be cold and on a level surface.

Automatic shutdown system stops engine if oil pressure is too low or engine temperature is too high.

☞ This unit has a low oil pressure shutdown switch. However, some conditions may cause engine damage before the engine shuts down. Check oil level often and do not use the oil pressure shutdown system to monitor oil level.

Extreme Cold Weather Operation

The two most common engine issues associated with cold operating environments are wet stacking and freezing of the breather system. Avoid these issues by considering the following recommendations:

- **Weather Protection.** Use a Miller Cold Weather Kit (Miller part no. 301482). Additional measures may be taken to shield the unit from the elements such as using wind barriers to reduce air flow.
- **Avoid light loading.** If not regularly welding with a moderate load, add auxiliary power loads such as industrial heaters and activate the air compressor (if applicable) to increase the engine load. If available, use smaller generators for applications with lower power requirements.
- **Reassess load banking preventative maintenance schedule.** During extreme conditions, formation of wet stacking may require load banking to be performed more frequently.
- **Consider adding a breather tube heater (Deutz engines only).** Kit available through Deutz (Deutz part no. 09991971). Standard feature on models with Kubota engines.

NOTICE – Diesel engines in Miller equipment are meant to operate optimally at moderate to rated load. Using light or no load for extended periods of time may cause wet-stacking or engine damage.

Follow run-in procedure in engine manual. If unburned fuel and oil collect in exhaust pipe, see Section 14.

Fuel

NOTICE – Do not use gasoline. Gasoline will damage engine.

- 1 Full
- 2 Diesel

Add fresh diesel fuel before starting (see engine maintenance label for fuel specifications). Leave filler neck empty to allow room for expansion.

Engine stops if fuel level is low.

Oil

After fueling, check oil with unit on level surface. If oil is not up to full mark on dipstick, add oil (see engine maintenance label).

Coolant

- 3 Coolant Overflow Tank

Check coolant level in coolant overflow tank. Coolant should touch bottom of neck pipe.

☞ To improve cold weather starting:

Keep battery in good condition. Store battery in warm area.

Use fuel formulated for cold weather (diesel fuel can gel in cold weather). Contact local fuel supplier for fuel information.

Use correct grade oil for cold weather (see engine maintenance label or engine manual).

5-7. Selecting Cable Sizes*

NOTICE – The Total Cable Length in Weld Circuit (see table below) is the combined length of both weld cables. For example, if the power source is 100 ft (30 m) from the workpiece, the total cable length in the weld circuit is 200 ft (2 cables x 100 ft). Use the 200 ft (60 m) column to determine cable size.

	Weld Cable Size** and Total Cable (Copper) Length in Weld Circuit Not Exceeding***							
	100 ft (30 m) or Less		150 ft (45 m)	200 ft (60 m)	250 ft (70 m)	300 ft (90 m)	350 ft (105 m)	400 ft (120 m)
Welding Amperes	10 - 60% Duty Cycle AWG (mm ²)	60 - 100% Duty Cycle AWG (mm ²)	10 - 100% Duty Cycle AWG (mm ²)					
100	4 (20)	4 (20)	4 (20)	3 (30)	2 (35)	1 (50)	1/0 (60)	1/0 (60)
150	3 (30)	3 (30)	2 (35)	1 (50)	1/0 (60)	2/0 (70)	3/0 (95)	3/0 (95)
200	3 (30)	2 (35)	1 (50)	1/0 (60)	2/0 (70)	3/0 (95)	4/0 (120)	4/0 (120)
250	2 (35)	1 (50)	1/0 (60)	2/0 (70)	3/0 (95)	4/0 (120)	2x2/0 (2x70)	2x2/0 (2x70)
300	1 (50)	1/0 (60)	2/0 (70)	3/0 (95)	4/0 (120)	2x2/0 (2x70)	2x3/0 (2x95)	2x3/0 (2x95)
350	1/0 (60)	2/0 (70)	3/0 (95)	4/0 (120)	2x2/0 (2x70)	2x3/0 (2x95)	2x3/0 (2x95)	2x4/0 (2x120)
400	1/0 (60)	2/0 (70)	3/0 (95)	4/0 (120)	2x2/0 (2x70)	2x3/0 (2x95)	2x4/0 (2x120)	2x4/0 (2x120)
500	2/0 (70)	3/0 (95)	4/0 (120)	2x2/0 (2x70)	2x3/0 (2x95)	2x4/0 (2x120)	3x3/0 (3x95)	3x3/0 (3x95)
600	3/0 (95)	4/0 (120)	2x2/0 (2x70)	2x3/0 (2x95)	2x4/0 (2x120)	3x3/0 (3x95)	3x4/0 (3x120)	3x4/0 (3x120)
700	4/0 (120)	2x2/0 (2x70)	2x3/0 (2x95)	2x4/0 (2x120)	3x3/0 (3x95)	3x4/0 (3x120)	3x4/0 (3x120)	4x4/0 (4x120)
800	4/0 (120)	2x2/0 (2x70)	2x3/0 (2x95)	2x4/0 (2x120)	3x4/0 (3x120)	3x4/0 (3x120)	4x4/0 (4x120)	4x4/0 (4x120)

* This chart is a general guideline and may not suit all applications. If cable overheats, use next size larger cable.

**Weld cable size (AWG) is based on either a 4 volts or less drop or a current density of at least 300 circular mils per ampere. () = mm² for metric use.

***For distances longer than those shown in this guide, see AWS Fact Sheet No. 39, Welding Cables, available from the American Welding Society at <http://www.aws.org>.

5-8. Weld Output Terminals



800 Models

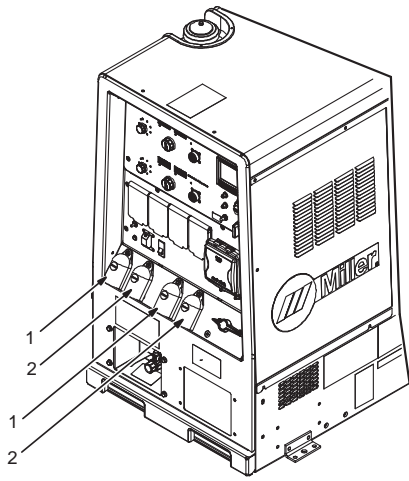

600 Models

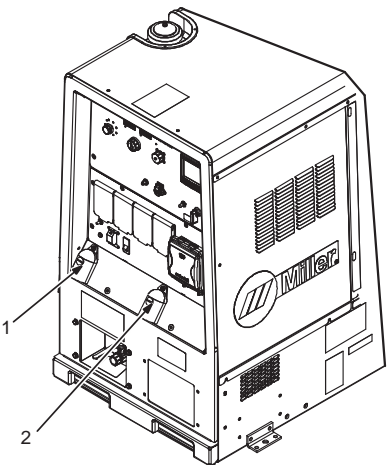

⚠ Turn off power before connecting to weld output terminals.

⚠ Do not use worn, damaged, undersized, or repaired cables.

- 1 Positive (+) Weld Output Terminal
- 2 Negative (-) Weld Output Terminal

5-9. Connecting Weld Output Cables



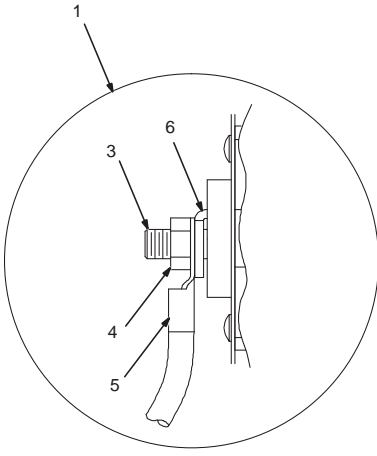

1

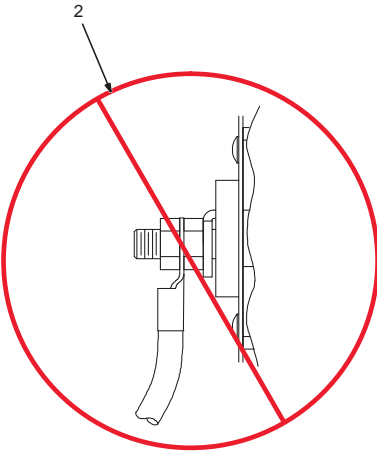

2

 3/4 in. (19 mm)

⚠ Stop engine.

⚠ Failure to properly connect weld cables may cause excessive heat and start a fire, or damage your machine.

Do not place anything between weld cable terminal and copper bar. Make sure that the surfaces of the weld cable terminal and copper bar are clean.

- 1 Correct Weld Cable Connection
- 2 Incorrect Weld Cable Connection
- 3 Weld Output Terminal
- 4 Supplied Weld Output Terminal Nut
- 5 Weld Cable Terminal
- 6 Copper Bar

Remove supplied nut from weld output terminal. Slide weld cable terminal onto weld output terminal and secure with nut so that weld cable terminal is tight against copper bar.

5-10. Connecting To Remote Receptacle

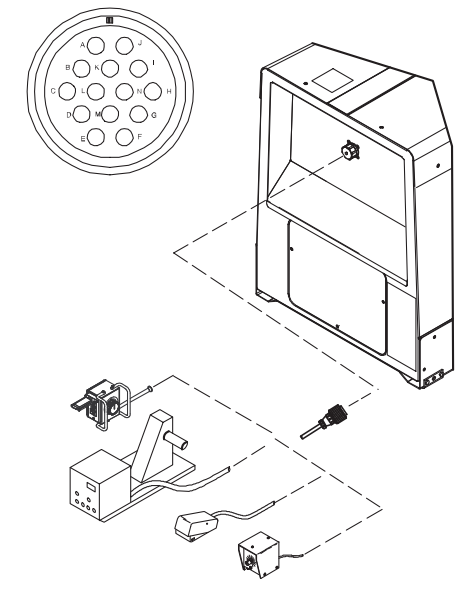

Remote	Socket*	Socket Information
24 Volts AC Output (Contactor)	A	24 volts AC. Protected by supplementary protector.
	B	Contact closure to A completes 24 volt AC contactor control circuit.
Remote Output Control	C	Output to remote control: +10 volts DC in MIG mode; 0 to +10 volts DC in Stick or TIG mode.
	D	Remote control circuit common.
	E	DC input command signal: 0 to +10 volts from min. to max. of remote control with Voltage/Amperage Adjust control at maximum.
A/V Amperage Voltage	F	Current feedback: 1 volt per 100 amperes.
	H	Voltage feedback: 1 volt per 10 arc volts.
GND	K	Chassis common.
Neutral	G	Circuit common for 24 volt AC circuit.

*The remaining sockets are not used.

Not all models have contactor control. See description of front panel controls and circuit diagram.

Accessories depend on unit capabilities.

5-11. Making Dual Operator CC Weld Connections With Separate Work Cables (800 Models)

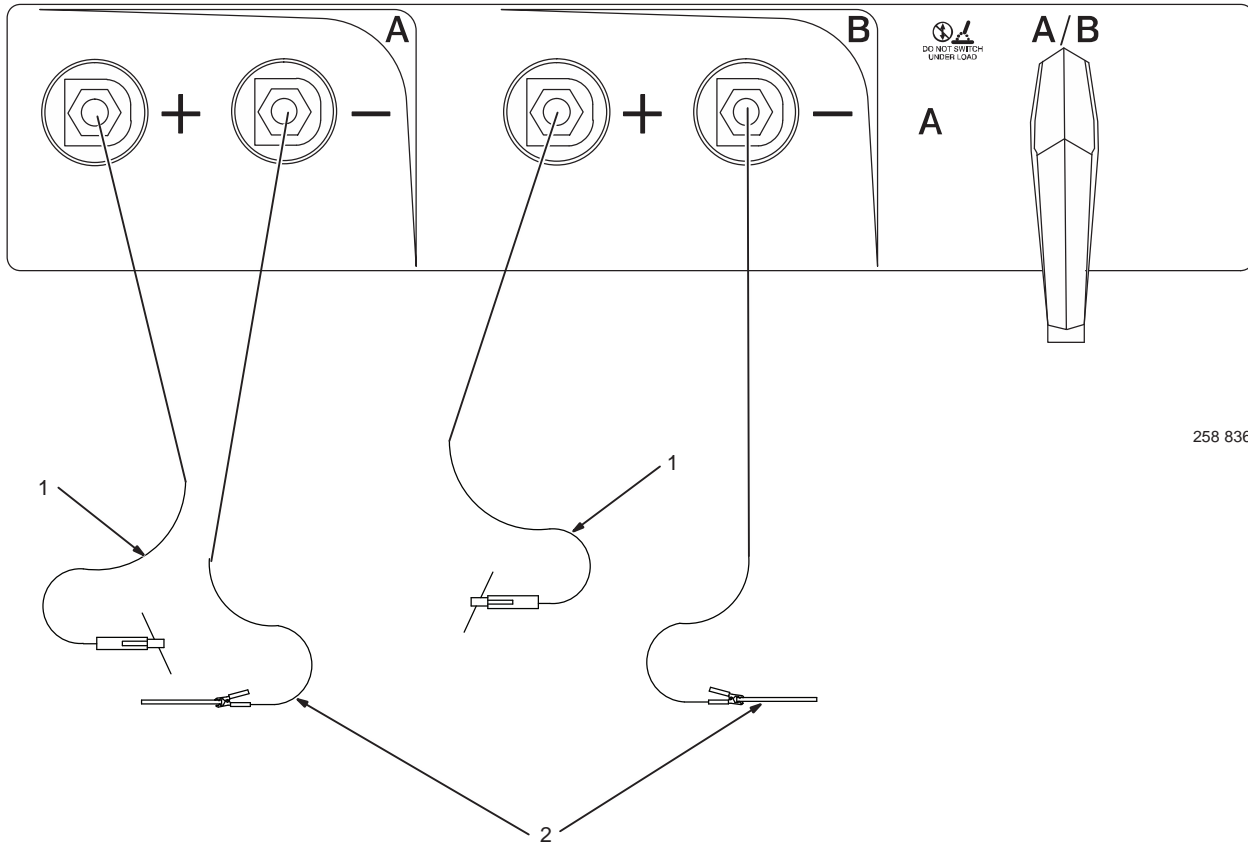
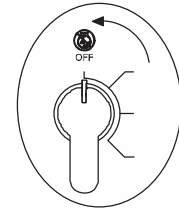

258 836

3/4 in.

Stop engine.

NOTICE – Do not exceed machine duty cycle.

Use Dual Operator mode for CC and CV welding (see Section 6).

Direct Current Electrode Positive (DCEP) connections are shown.

See Selecting Cable Size table for proper cable size.

- 1 Electrode Holder Cables
- 2 Work Cables

For Stick/TIG welding Direct Current Electrode Positive (DCEP), connect work cables to Negative (-) terminals and electrode holder cables to Positive (+) terminals.

For Stick/TIG Direct Current Electrode Negative (DCEN), connect work cables to Positive (+) terminals and electrode holder cables to Negative (-) terminals.

Be sure Process Selector switches are set correctly. See Section 6-4.

5-12. Making Dual Operator CC Weld Connections With Common Work Cable (800 Models)

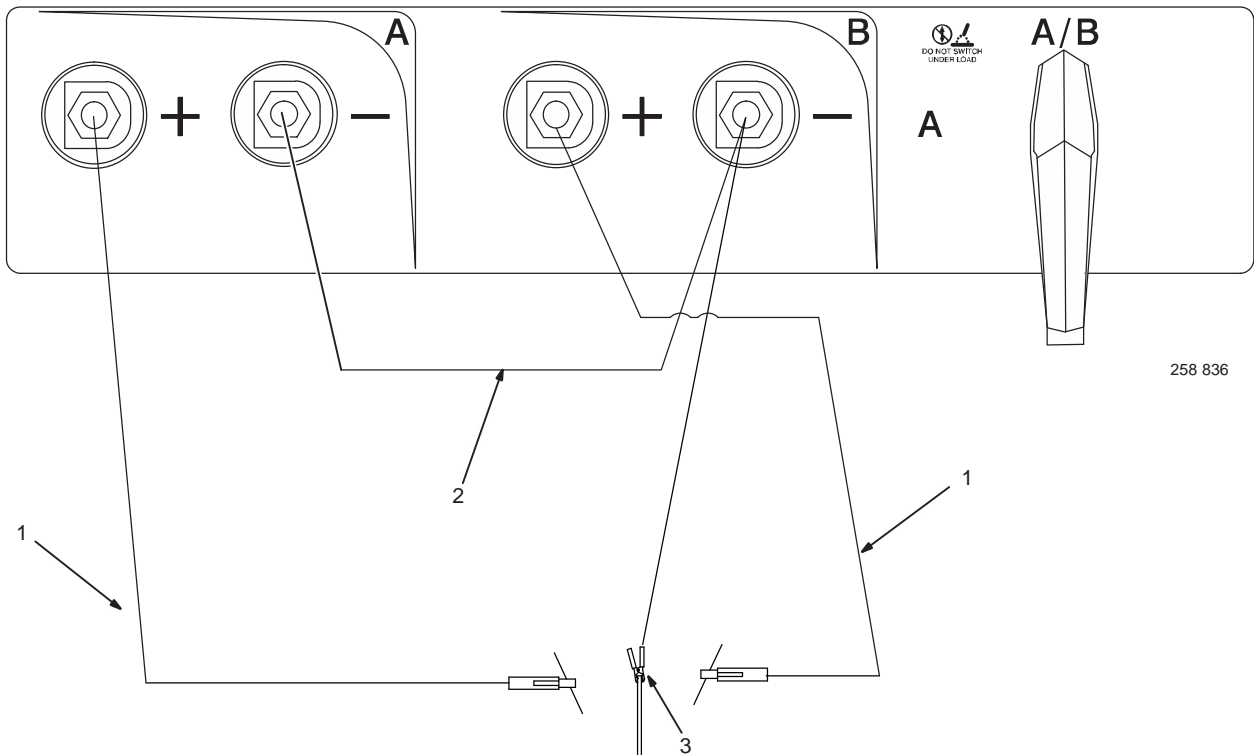
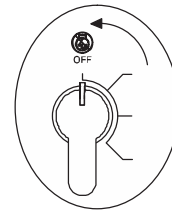

258 836

3/4 in.

⚠ Stop engine.

⚠ Failure to properly size and connect weld cables may cause excessive heat and start a fire, or damage your machine.

NOTICE – When making weld connections with a common work cable, connect weld cable of adequate size between Negative (-) weld output terminals, and connect a single weld cable of adequate size from Welder B (right) Negative (-) terminal to the workpiece.

NOTICE – When using these connections as a common work terminal, all connections must be of the same polarity.

NOTICE – For common work connection, work cable must be able to carry combined weld output of both modules (see *Selecting Cable Size table* for proper cable size).

NOTICE – Do not exceed machine duty cycle.

Use Dual Operator mode for CC and CV welding (see Section 6).

Direct Current Electrode Positive (DCEP) connections are shown.

- 1 Electrode Holder Cables
- 2 Work Jumper Cable
- 3 Common Work Cable

For Stick/TIG welding Direct Current Electrode Positive (DCEP), connect common

work cable and work jumper cable to Welder B (right) Negative (-) terminal. Connect other end of work jumper cable to Welder A (left) Negative (-) terminal.

Connect electrode holder cables to Positive (+) terminals.

For Stick/TIG Direct Current Electrode Negative (DCEN), connect common work cable and work jumper cable to Welder B (right) Positive (+) terminal. Connect other end of work jumper cable to Welder A (left) Positive (+) terminal.

Connect electrode holder cables to Negative (-) terminals.

Be sure Process Selector switches are set correctly. See Section 6-4.

5-13. Making Dual Operator CV Weld Connections With Separate Work Cables (800 Models)

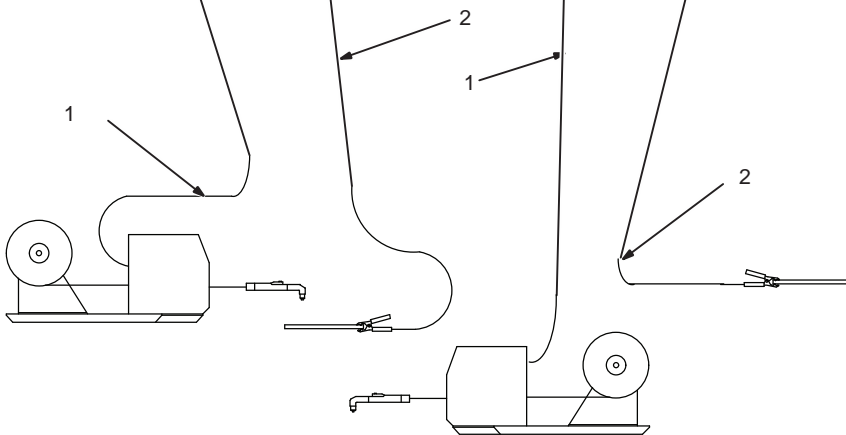
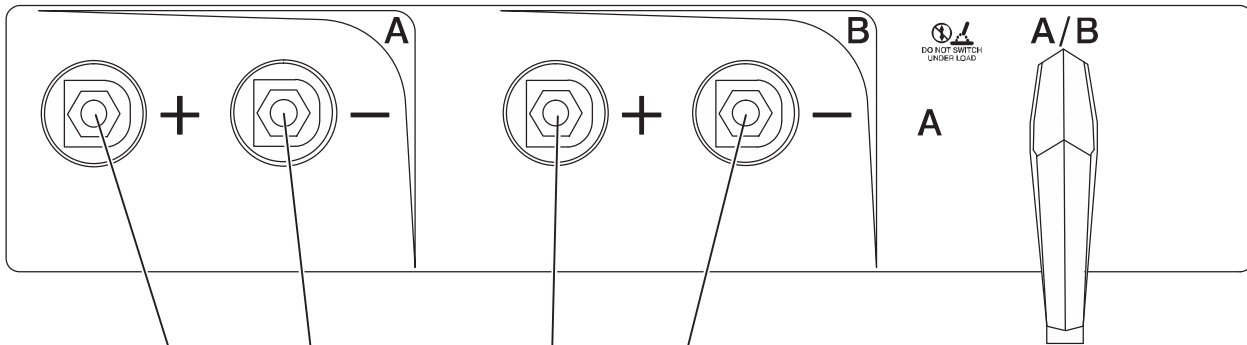
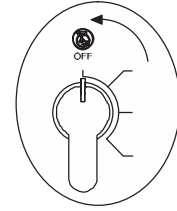

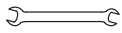

258 836

 3/4 in.

 **Stop engine.**

NOTICE – Do not exceed machine duty cycle.

 Use Dual Operator mode for CC and CV welding (see Section 6).

 Direct Current Electrode Positive (DCEP) connections are shown.

See Selecting Cable Size table for proper cable size.

1 Wire Feeder Cables

2 Work Cables

For MIG and FCAW welding Direct Current Electrode Positive (DCEP), connect work cables to Negative (-) terminals and wire feeder cables to Positive (+) terminals.

For MIG and FCAW welding Direct Current Electrode Negative (DCEN), connect work cables to Positive (+) terminals and wire feeder cables to Negative (-) terminals.

 Be sure Process Selector switches are set correctly. See Section 6-4.

5-14. Making Dual Operator CV Weld Connections With Common Work Cable (800 Models)

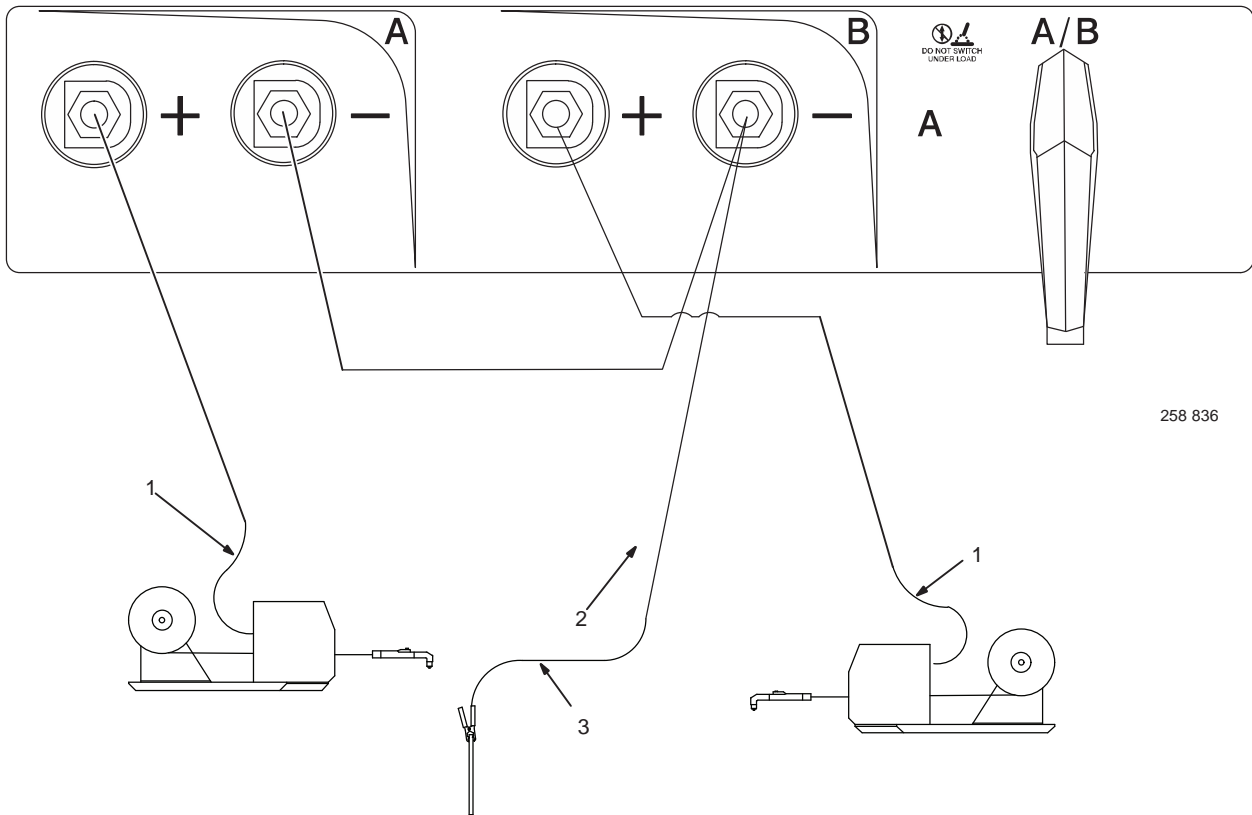
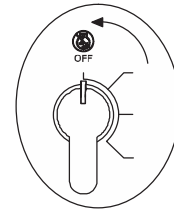

258 836

3/4 in.

Stop engine.

Failure to properly size and connect weld cables may cause excessive heat and start a fire, or damage your machine.

NOTICE – When making weld connections with a common work cable, connect weld cable of adequate size between Negative (-) weld output terminals, and connect a single weld cable of adequate size from Welder B (right) Negative (-) terminal to the workpiece.

NOTICE – When using these connections as a common work terminal, all connections must be of the same polarity.

NOTICE – For common work connection, work cable must be able to carry combined weld output of both modules (see *Selecting Cable Size table* for proper cable size).

NOTICE – Do not exceed machine duty cycle.

Use Dual Operator mode for CC and CV welding (see Section 6).

Direct Current Electrode Positive (DCEP) connections are shown.

- 1 Wire Feeder Cables
- 2 Work Jumper Cable
- 3 Common Work Cable

For MIG and FCAW welding Direct Current Electrode Positive (DCEP), connect

common work cable and work jumper cable to Welder B (right) Negative (-) terminal. Connect other end of work jumper cable to Welder A (left) Negative (-) terminal.

Connect wire feeder cables to Positive (+) terminals.

For MIG and FCAW Direct Current Electrode Negative (DCEN), connect common work cable and work jumper cable to Welder B (right) Positive (+) terminal. Connect other end of work jumper cable to Welder A (left) Positive (+) terminal.

Connect wire feeder cables to Negative (-) terminals.

Be sure Process Selector switches are set correctly. See Section 6-4.

5-15. Making Dual Operator CC And CV Weld Connections With Separate Work Cables (800 Models)

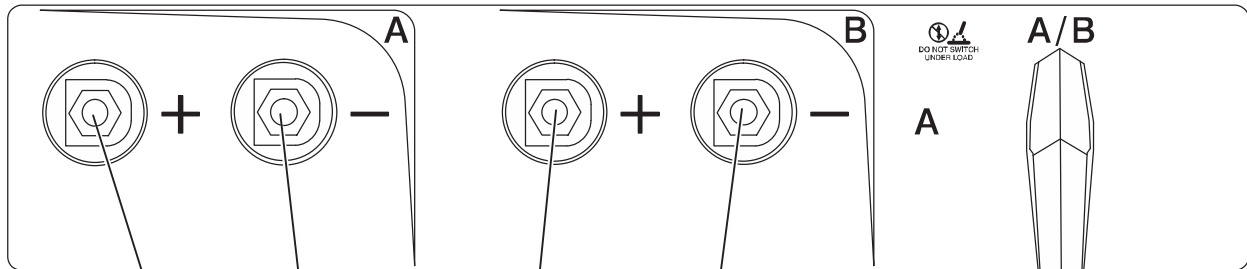
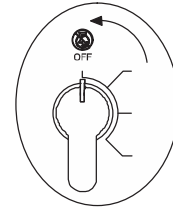

258 836

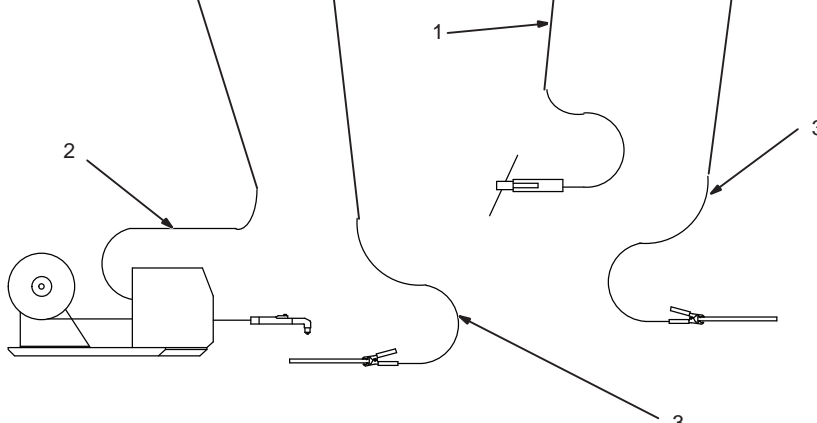

3/4 in.

Stop engine.

NOTICE – Do not exceed machine duty cycle.

Use Dual Operator mode for CC and CV welding (see Section 6).

Direct Current Electrode Positive (DCEP) connections are shown.

See Selecting Cable Size table for proper cable size.

1 Electrode Holder Cable

2 Wire Feeder Cable

3 Work Cables

For Stick/TIG welding Direct Current Electrode Positive (DCEP), connect work cables to Negative (-) terminals and electrode holder cables to Positive (+) terminals.

For Stick/TIG welding Direct Current Electrode Negative (DCEN), connect work cables to Positive (+) terminals and electrode holder cables to Negative (-) terminals.

For MIG and FCAW welding Direct Current Electrode Positive (DCEP), connect work cable to Negative (-) terminal and wire feeder cable to Positive (+) terminal.

For MIG and FCAW welding Direct Current Electrode Negative (DCEN), connect work cable to Positive (+) terminal and wire feeder cable to Negative (-) terminal.

Be sure Process Selector switches are set correctly. See Section 6-4.

5-16. Making Dual Operator CC And CV Weld Connections With Common Work Cable (800 Models)

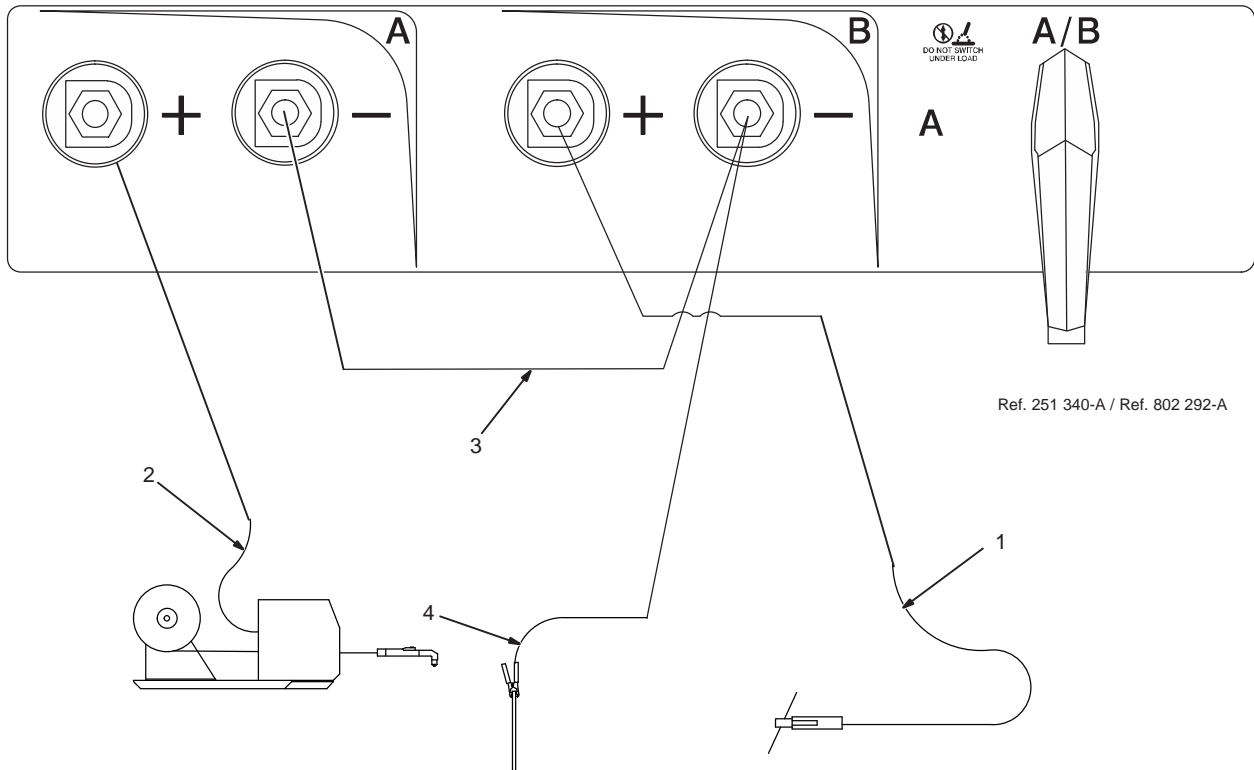
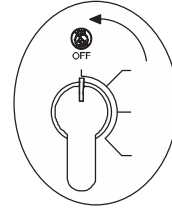

 3/4 in.

 **Stop engine.**

 **Failure to properly size and connect weld cables may cause excessive heat and start a fire, or damage your machine.**

NOTICE – When making weld connections with a common work cable, connect weld cable of adequate size between Negative (-) weld output terminals, and connect a single weld cable of adequate size from Welder B (right) Negative (-) terminal to the workpiece.

NOTICE – When using these connections as a common work terminal, all connections must be of the same polarity.

NOTICE – For common work connection, work cable must be able to carry combined weld output of both modules (see *Selecting Cable Size table for proper cable size*).

NOTICE – Do not exceed machine duty cycle.

 Use Dual Operator mode for CC and CV welding (see Section 6).

 Direct Current Electrode Positive (DCEP) connections are shown.

- 1 Electrode Holder Cable
- 2 Wire Feeder Cable
- 3 Work Jumper Cable
- 4 Common Work Cable

For Direct Current Electrode Positive (DCEP), connect common work cable and work jumper cable to Welder B (right) Negative (-) terminal. Connect other end of work jumper cable to Welder A (left) Negative (-) terminal.

Connect electrode holder cable to one Positive (+) terminal, and wire feeder cable to remaining Positive (+) terminal.

For Direct Current Electrode Negative (DCEN), connect common work cable and work jumper cable to Welder B (right) Positive (+) terminal. Connect other end of work jumper cable to Welder A (left) Positive (+) terminal.

Connect electrode holder cable to one Negative (-) terminal, and wire feeder cable to remaining Negative (-) terminal.

 Be sure Process Selector switches are set correctly. See Section 6-4.

5-17. Making Single Operator CC Weld Connections (800 Models)

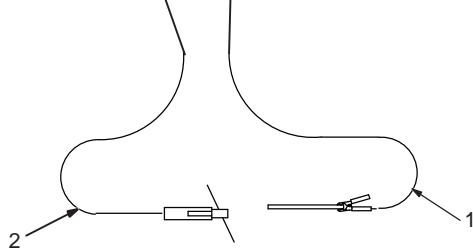
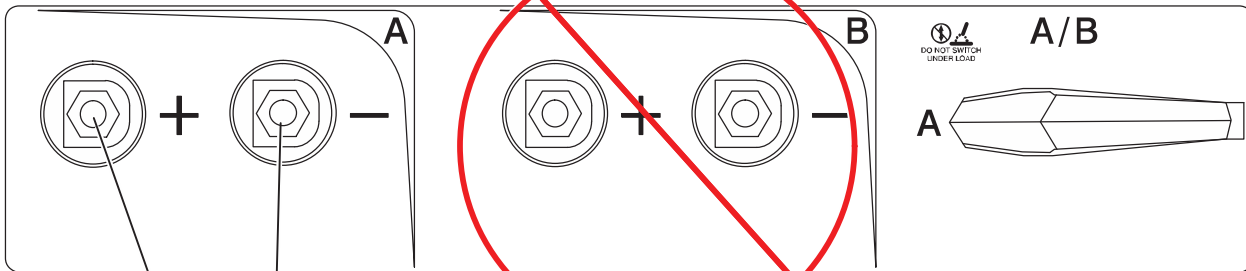
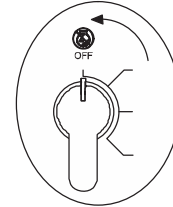

258 836

3/4 in.

Stop engine.

NOTICE – Do not exceed machine duty cycle.

Use Single Operator mode for CC welding only. Welder B weld output terminals are disabled in Single Operator mode (see Section 6).

Direct Current Electrode Positive (DCEP) connections are shown.

See Selecting Cable Size table for proper cable size.

1 Electrode Holder Cable

2 Work Cable

For Stick/TIG welding Direct Current Electrode Positive (DCEP), connect work cable

to Negative (-) terminals and electrode holder cable to Positive (+) terminals.

For Stick/TIG welding Direct Current Electrode Negative (DCEN), connect work cable to Positive (+) terminals and electrode holder cable to Negative (-) terminals.

Be sure Process Selector switch is set correctly. See Section 6-4.

5-18. Connecting To The Air Compressor (Air Pak Models)

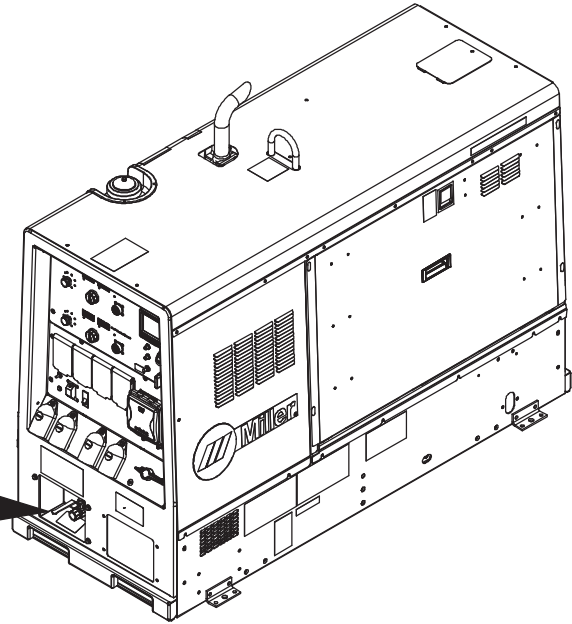
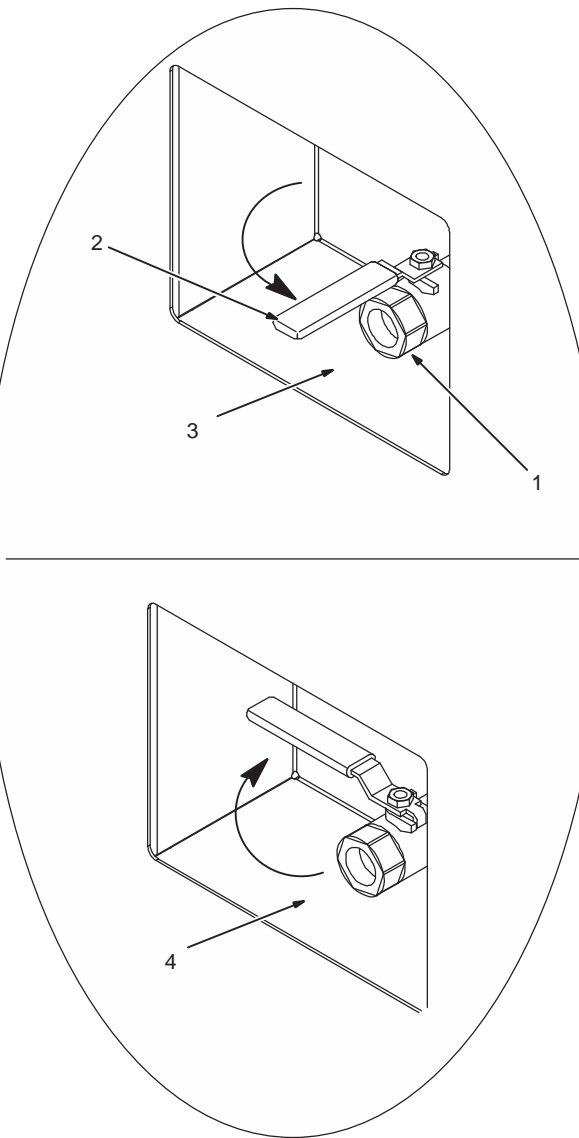
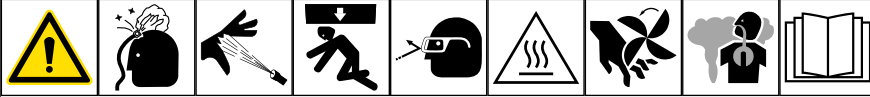

907752

⚠ Stop engine and release air pressure before servicing compressor.

⚠ Air pressure is present at air shutoff valve whenever Engine Display on front panel indicates air pressure.

- 1 3/4 in. NPT Air Pressure Fitting
- 2 Air Shutoff Valve
- 3 Open Position
- 4 Closed Position

Connect air hose with 3/4 in. NPT fitting (not supplied) to air shutoff valve.

Be sure valve is in open position when using air compressor.

The compressor runs and air pressure is available whenever the engine is running and the front panel Compressor switch is moved to the On position (see Section 6-2).

Run engine at weld/power speed for maximum air compressor output. Compressor output is reduced when engine is running at idle speed.

The air compressor will not start if still under pressure. If air compressor is turned off, wait for air pressure to bleed off (about 20 seconds) before turning air compressor on again.

Using the air compressor does not significantly affect weld or generator power output.





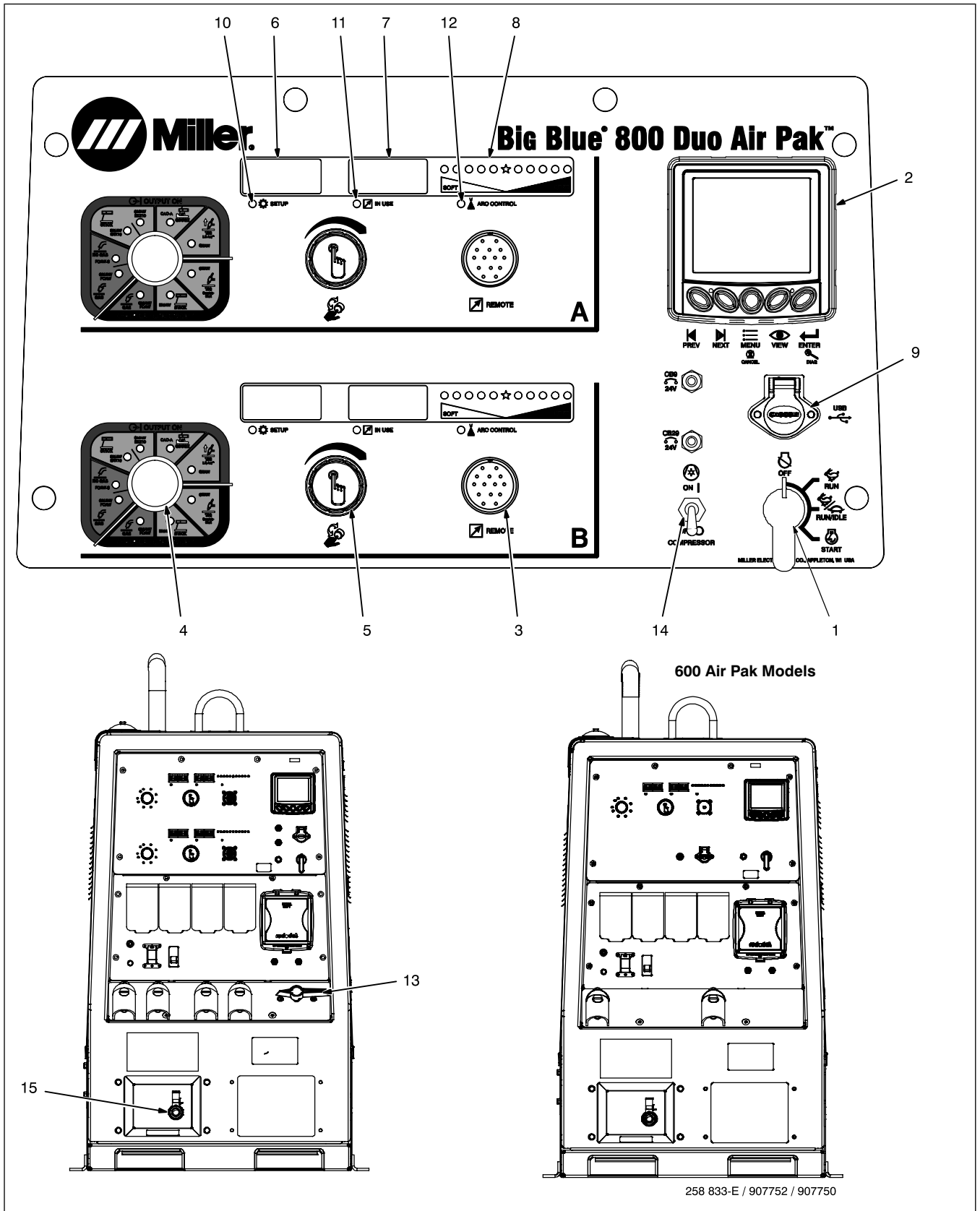



SECTION 6 – OPERATION

6-1. Front Panel Controls



258 833-E / 907752 / 907750

6-2. Description Of Front Panel Controls (See Section 6-1)

									
Engine Starting Controls									
1 Engine Control Switch	Push the control to use as Select button.			Allows software updates from a USB drive (see Section 6-12). A summary file of recorded data from the unit will be saved to a USB drive that is inserted (see Section 6-13).					
Use switch to start engine, select engine speed, and stop engine.	<p> To access Arc Control setting, push and hold Adjust control for 1 second, then release. Rotate counterclockwise to set softer arc control. Rotate clockwise to set stiffer arc control. Push Adjust control in and release to save Arc Control setting. Arc Control setting will time out after 5 seconds of inactivity.</p> <p> To access Service Menu, push and hold Adjust control for 5 seconds, then release. See Section 6-5 for Service Menu operation. Service Menu will time out after 5 seconds of inactivity.</p>			Indicator Lights					
In Run position, engine runs at weld/power speed. In Run/Idle position, engine runs at idle speed with no generator power or weld load, and weld/power speed with load applied.	Weld Meters			10 Setup Light					
NOTICE – Diesel engines in Miller equipment are meant to operate optimally at moderate to rated load. Using light or no load for extended periods of time may cause wet-stacking or engine damage.	<p> Weld meters also work in combination to display troubleshooting error codes.</p>			Illuminates when in the Service Menu.					
2 Engine Display	6 DC Voltmeter			11 In Use Light					
See Section 13 for engine display information.	<p>Voltmeter displays preset voltage (GMAW/FCAW welding) with contactor off, and actual output voltage with the contactor on. Voltmeter displays voltage at the weld output terminals, but not necessarily the welding arc due to resistance of cable and connections.</p> <p>To set voltage, turn Process/Contactor switch to GMAW or FCAW position. Turn V/A control until desired voltage is displayed on Voltmeter. When welding is finished, voltmeter displays average weld voltage and then defaults to preset voltage.</p>			Illuminates when connected to an ArcReach accessory.					
Weld Controls									
3 Remote Control Receptacle	7 DC Ammeter			12 Arc Control Light					
Use receptacle to connect remote controls, wire feeders, and tools requiring 24 VAC.	<p>Ammeter displays preset amperage (Stick and TIG only) when not welding, and actual output amperage when welding.</p> <p>To set amperage, turn Process/Contactor switch to Stick or TIG position. Turn V/A control until desired amperage is displayed on Ammeter. When welding is finished, ammeter displays average weld amperage and then defaults to preset amperage.</p>			Illuminates when in the Arc Control settings.					
When a remote control is connected to the Remote receptacle, the Auto Remote Sense (ARS) feature automatically switches voltage/amperage control to the remote control (see Section 6-10).	8 Arc Control Meter			13 Welder Selector Switch (800 Models)					
With remote control connected, weld output is determined by a combination of front panel and remote control voltage/amperage settings.	<p>Displays current Arc Control setting. Default value for all processes is 0. Arc Control settings adjust: Soft/Stiff for SMAW processes, Auto Stop for GTAW processes, and inductance for FCAW and GMAW processes. For softer settings, the LEDs to the left of the star illuminate. For stiffer settings, the LEDs to the right of the star illuminate. No Arc Control settings are accessible for GTAW Remote. See Section 6-6</p>			NOTICE – Do not switch under load.					
If no remote control is connected to the Remote receptacle, the front panel Voltage/Amperage control adjusts voltage and amperage.	Other Receptacles			Use switch to select Dual Operator or Single Operator welding mode.					
<p> If a remote device connected to Remote Receptacle is faulty or is disconnected during operation, the meters display CHEK REMT. Clear fault by stopping and restarting the unit or by turning Process/Contactor switch to another position.</p>	9 USB Receptacle			Place switch in Welder A/Welder B (dual operator) position for CC and CV output from Welder A (left) and Welder B (right) weld output terminals. Control the weld output from the terminals on each side using the weld controls on that same side.					
4 Process/Contactor Switch				Place switch in Welder A (single operator) position for weld output from Welder A (left) weld output terminals only.					
See Section 6-4 for Process/Contactor switch information.				<p> Welder B (right) weld output terminals are disabled in Single Operator mode. Connect only to Welder A (left) terminals for Single Operator operation.</p>					
5 Adjust Control/Select Button				Compressor Controls (Air Pak Models)					
Adjust Control				14 Air Compressor Switch					
With Process/Contactor Switch in any SMAW or GTAW process, turn Adjust control to adjust preset amperage. With Process/Contactor switch in any FCAW or GMAW process, turn Adjust control to adjust preset voltage.				Use switch to turn air compressor on and off. Air pressure is present at the compressor air shutoff valve whenever the compressor is running. The compressor shuts off when the engine stops. To use air, the compressor must be turned on each time the engine is started.					
Select Button				The air compressor will not start if still under pressure. If air compressor is turned off, wait for air pressure to bleed off (about 20 seconds) before turning air compressor on again.					
<p> Air pressure is present at valve whenever Air Pressure display (part of engine display, see Section 13) indicates air pressure.</p>									
Close valve to stop air flow when connecting or changing tools or air hoses (see Section 5-18).									

6-3. Engine Starting Sequence

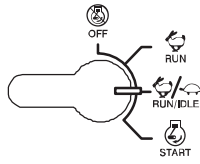
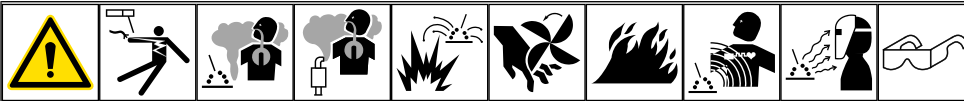

Wait to Start/Preheating

Service Reminder Remaining

Engine Oil	0
Compressor Oil	0

Service Reminder Remaining

Engine Oil	480
Compressor Oil	495

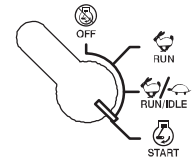

NOTICE – Do not use ether or other starting fluids. Using starting fluids voids warranty.

If engine does not start, let engine come to a complete stop before attempting restart.

To Start:

- 1 Wait to Start/Preheating Display

The Wait to Start display appears when the Engine Control switch is placed in the Run or Run/Idle position.

Glow plugs function automatically according to ambient temperature. The operator needs to pause at either switch position while the engine controller goes through the preheat

sequence. Once this message clears, the engine can be started.

Turn Engine Control switch to Start. Release Engine Control switch when engine starts.

To Stop: turn Engine Control switch to Off position.

6-4. Process/Contactor Switch

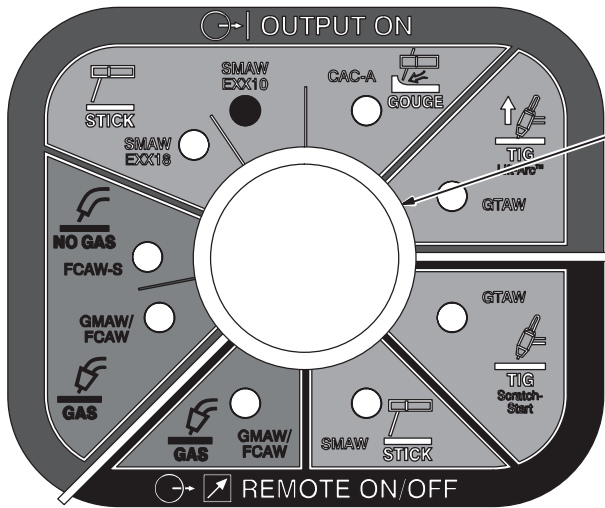

1 Process/Contactor Switch

Warning: Weld output terminals are energized when Process/Contactor switch is in an Electrode Hot position and the engine is running.

Use switch to select weld process and weld output on/off control (see table below).

Place switch in Remote On/Off Switch Required positions to turn weld output on and off with a device connected to the Remote receptacle.











Place switch in Output On positions for weld output to be on whenever the engine is running.

Use the Lift-Arc TIG mode for TIG (GTAW) welding using the Lift-Arc TIG starting procedure.

	Process/Contactor Switch Setting	Typical Process Applications (DC Only)
Output On	Output On – GMAW/FCAW (MIG)	MIG solid wire and dual shield flux core use a voltage sensing (VS) feeder that does not require a control cable back to the welder/generator.
	Output On – FCAW-S (Electrode Negative)	FCAW (Flux Cored Arc Welding - self shielded) uses a voltage sensing (VS) feeder that does not require a control cable back to the welder/generator.
	Output On - SMAW (STICK XX18 and STICK XX10)	Stick welding with or without a remote amperage control. Strike an arc to start welding.
	Output On – GTAW (Lift-Arc TIG)	Lift-Arc TIG: touch tungsten to work and lift to start welding. Uses circuitry internal to the welder/generator to aid arc start. Can be used with or without a remote control. Auto Crater option can be enabled/disabled using the Service Menu.

	Process/Contactor Switch Setting	Typical Process Applications (DC Only)
	Output On – CAC-A (Air Carbon Arc Gouging)	Gouging with or without a remote amperage control. Strike an arc to start gouging.
Remote On/Off Required	Remote ON/OFF Required - GTAW (Remote TIG)	High Frequency TIG or Scratch Start TIG welding. High frequency TIG starting with remote control allows remote On/Off and Amperage control. Another typical application is a simple TIG rig with a remote control device.
	Remote ON/OFF Required - SMAW (Remote Stick)	Stick welding with RHC-14 control allows remote On/Off and Amperage control. This can help eliminate accidental arc strikes.
	Remote ON/OFF Required - GMAW/FCAW (Remote MIG)	MIG solid wire and dual shield flux core using a constant speed feeder. Use feeders with 14-pin remote voltage control, or use a Spoolmatic 30A with WC24 control.

6-5. Service Menu

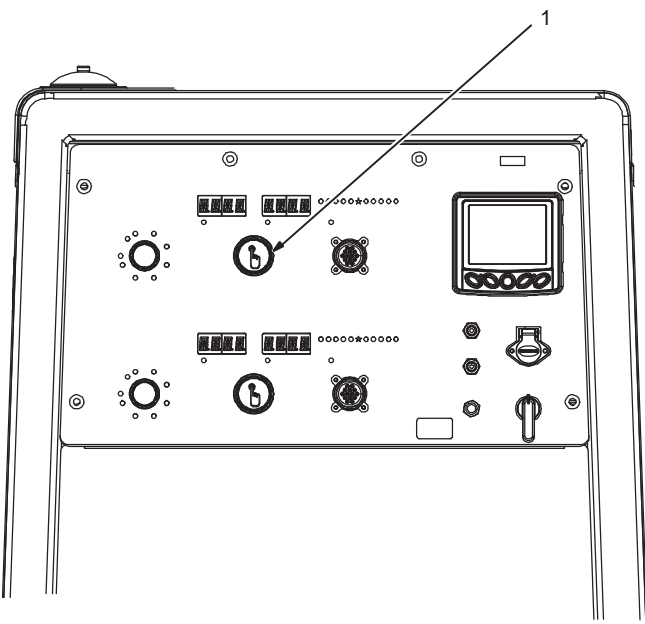

1 Adjust Control/Select Button

Press and hold control for 5 seconds, then release to access the Service Menu. Rotate the knob to scroll through the menu items. Press and release the control to access the options and information within each menu item.

Rotate the control counterclockwise to decrease the value or select NO/OFF. Rotate the control clockwise to increase the value or select YES/ON.

Press and release control to save selection. After 5 seconds of inactivity, the menu will time out and the selection will not be saved.

 *Big Blue 800 Duo Air Pak shown.*

Menu Item	Selectable Item Option(s)	Description
HOT STRT (Only accessible in SMAW processes)	RAMP OFF	Disables Hot Start option.
	RAMP 0.50	Sets time the current transitions from hot start to the preset current. Factory preset is 0.5 seconds for both XX10 and XX18. Range is 0 to 1 second settable in 0.1 second increments.
AUTO CRTR (Only accessible in GTAW processes)	ATCR ON	Enables Auto Crater option. Auto Crater gradually ramps current down after the Auto-Stop threshold is met. This enables operators to better control the metal at the end of welding and avoid the formation of an undesirable crater while still providing shielding gas.
	ATCR OFF	Disables Auto Crater option.
DIG RNGE	0–200 0–100	Sets current limit above preset amperage between 0 and 200 amps for XX10 or 0 and 100 amps for XX18.
VRD	VRD ON	Enables VRD (Voltage Reducing Device) option, lowering open-circuit voltage.
	VRD OFF	Disables VRD (Voltage Reducing Device) option.
SOFT WARE	--	Displays the current revision of firmware installed.
FACT RSET	RSET YES	Resets all settings to factory defaults.
	RSET NO	All settings remain at previous settings.
STUK STIK	ON	Enables Stuk Stik. Reduces current to min. when electrode is shorted.
	OFF	Disables Stuk Stik. Current stays at Dig current when electrode is shorted.

6-6. Arc Control Settings

☞ Arc Control is not active when the Process/Contactor switch is in the following positions:

Output On

Remote ON/OFF: GTAW (Remote TIG)

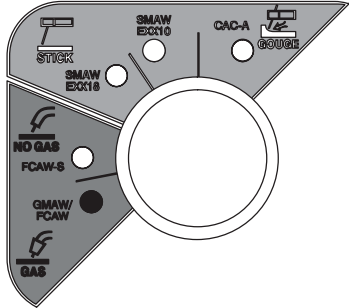
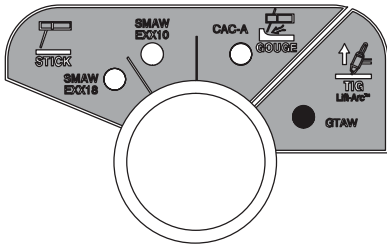
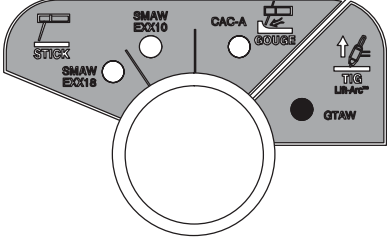
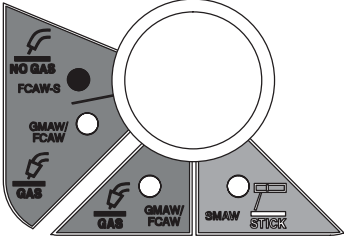
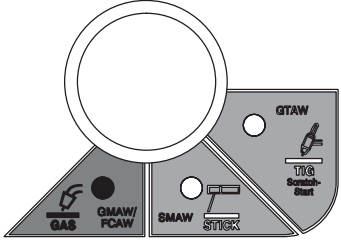
Process/Contactor Switch	Arc Control	
<p>GMAW/FCAW</p>  <p>Voltage sensing feeder</p>	SOFT (25 to 1)	Starting point for stainless steel wire (high inductance) SOFT -12
	★ (0)	Starting point for mild steel wire
	STIFF (1 to 25)	Starting point for aluminum wire (low inductance) STIF 12
<p>GTAW (TIG Lift Arc)</p> 	★ (0)	Starting point.
	STOP (-5 to 5)	Auto-Stop sensitivity ¹ (from most sensitive [-5] to least sensitive [5]) Auto-Stop determines the arc length (voltage) threshold the operator must exceed to terminate the arc. If arc terminates prematurely, increase the Auto-Stop.
<p>GTAW (TIG Lift Arc)</p> 	★ (0)	Starting point
	STOP (-5 to 5)	Auto Crater sensitivity ² (from most sensitive [-5] to least sensitive [5]).
<p>FCAW-S (NO GAS)</p> 	SOFT (25 to 1)	
	★ (0)	Starting point
	STIFF (1 to 25)	
<p>GMAW/FCAW</p>  <p>Wire feeder connects to Remote receptacle</p>	SOFT (25 to 1)	Starting point for stainless steel wire (high inductance) SOFT -12
	★ (0)	Starting point for mild steel wire
	STIFF (1 to 25)	Starting point for aluminum wire (low inductance) STIF 12 Starting point for dual shield flux core, vertical overhead STIF 25

¹ When Auto-Crater is off (see Service menu)

² When Auto-Crater is on (see Service menu)

6-7. Dynamic Dig Settings

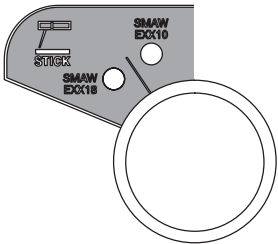
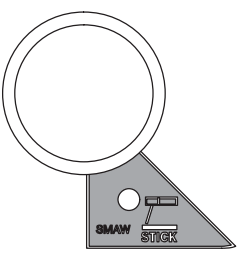
Process/Contactor Switch	Arc Control ¹		
<p style="text-align: center;">STICK</p> 	<p>SOFT (25 to 1)</p> <p>★ (0)</p> <p>STIFF (1 to 25)</p>	<p>Soft: Increases puddle fluidity and widens the arc cone.</p> <p>Starting point for XX10 electrode/open root vertical down joint</p> <p>Stiff: Decreases puddle fluidity and narrows the arc cone.</p>	
	Dig Range XX10²		
	(0)	Less aggressive arc with reduced penetration.	
	(100)	Starting point for downhill pipe (factory default)	
	(200)	More aggressive arc with increased penetration.	
Dig Range XX18²			
(0)	Less aggressive arc with reduced penetration.		
(50)	Starting point for all XX18 welding applications		
(100)	More aggressive arc with increased penetration.		
<p style="text-align: center;">SMAW</p> 	Arc Control¹		
	<p>SOFT (25 to 1)</p> <p>★ (0)</p> <p>STIFF (1 to 25)</p>	<p>Soft: Increases puddle fluidity and widens the arc cone.</p> <p>Starting point for XX10, XX11, XX13, XX14, XX18, XX24, and XX22 electrodes</p> <p>Stiff: Decreases puddle fluidity and narrows the arc cone.</p>	
	Dig Range²		
	(0)	Starting point for XX18 rod	<input type="text" value="DIG"/> <input type="text" value="50"/>
	(100)	Starting point for downhill pipe (factory default)	<input type="text" value="DIG"/> <input type="text" value="100"/>
(200)			

1 Accessed by pressing and releasing the Arc Control Knob, then rotate the knob to adjust.

2 Accessed by pressing and holding the Arc Control Knob and when "DIG" appears on the screen release. Press and release the knob to select this menu option then rotate the knob to adjust.

6-8. Stick Start Procedure—Scratch Start Technique



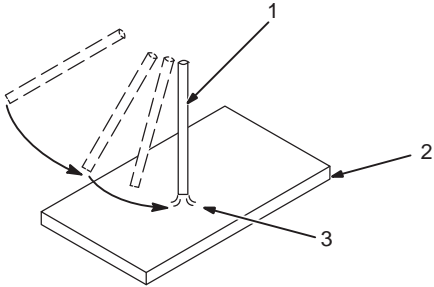

With Stick selected, start arc as follows:

- 1 Electrode
- 2 Workpiece
- 3 Arc

Drag electrode across workpiece like striking a match; lift electrode slightly after touching work. If arc goes out electrode was lifted too high. If electrode sticks to workpiece, use a quick twist to free it.

Miller recommends Hobart filler metals.

6-9. Lift-Arc™ TIG With Auto-Stop™ And Auto-Crater™



Arc Start With Lift-Arc

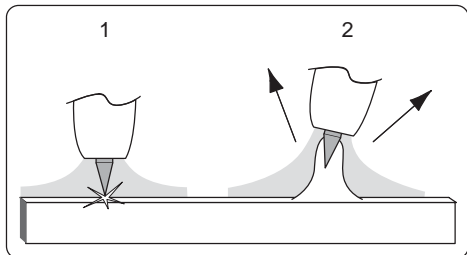

Arc Start With Lift-Arc TIG

Lift-Arc is used for the DCEN GTAW process when HF Start method is not permitted.

Select Lift-Arc at Process/Contactor switch.

Turn gas on.

1. Touch or scratch.
2. Lift at any angle.

Touch tungsten electrode to workpiece at weld start point. Slowly lift electrode. Arc is started when electrode is lifted.

Maintain shielding gas coverage and eliminate tungsten and workpiece contamination by using Auto-Crater or Auto-Stop to end the arc.

Arc End With Auto-Stop

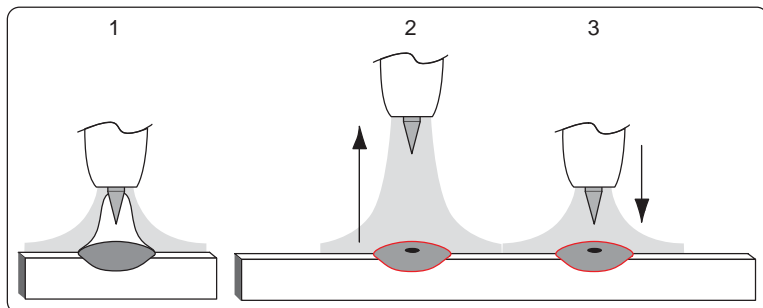

Arc End With Auto-Stop

1. While welding.
2. Lift torch to start Auto-Stop. Arc stops.
3. Move torch back down to maintain gas coverage and prevent contamination.

Arc End With Auto-Crater

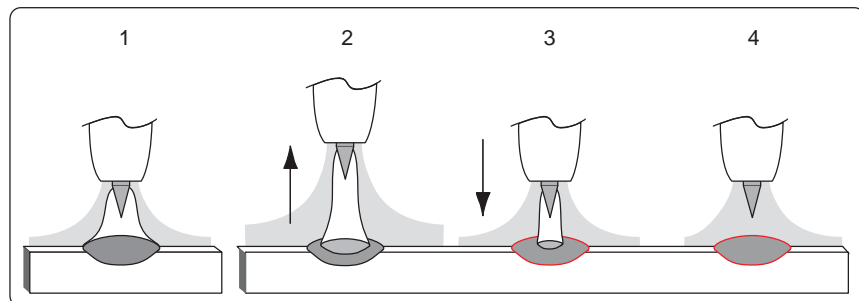

Arc End With Auto-Crater

 Remote control is not needed when using Auto-Crater.

1. While welding.
2. Lift torch slightly to start Auto-Crater end (current is reduced).
3. Lower torch. Weld current ramps down.
4. Shielding gas continues until shut off.

 Miller recommends Hobart filler metals.

6-10. Remote Voltage/Amperage Control

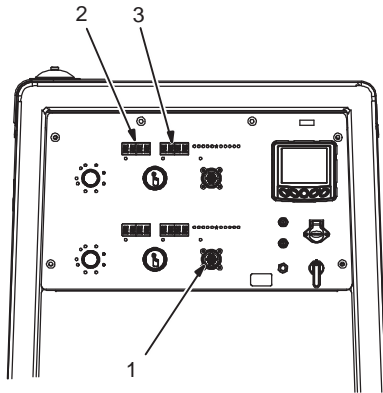

☞ Big Blue 800 Duo Air Pak shown.

1 Remote Receptacle

Connect optional remote control to receptacle (see Section 5-10).

☞ When a remote control is connected to the Remote receptacle, the Auto Remote Sense feature automatically switches voltage/amperage control to the remote control. When a device is connected to the Remote receptacle, remote voltage/amperage control is always available regardless of the position of the Process/Contactor switch.

2 Voltmeter

3 Ammeter

CC Welding

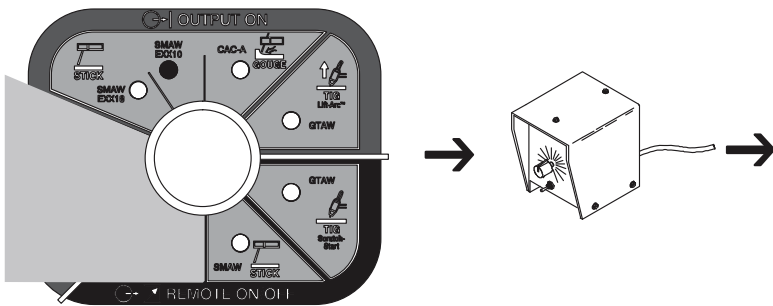

CC Welding

Connect remote control to remote receptacle. Set TIG or STICK process.

Turn remote control On. Adjust optional remote control to 100%.

Voltmeter shows open-circuit voltage when not welding, arc voltage while welding.

Ammeter shows preset output when not welding, actual amperage while welding.

Set V/A control to desired maximum weld output using weld meters.

Adjust optional remote control to desired weld output (max 205 A DC, min 20 A DC).

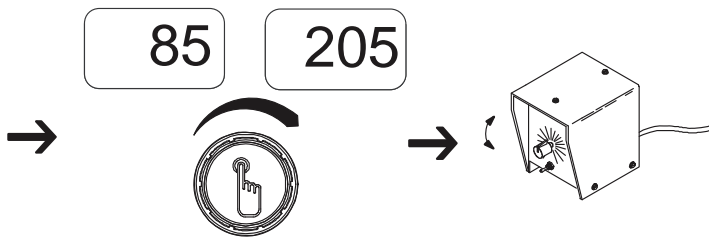

CV Welding

Connect remote control to remote receptacle. Set WIRE process.

Output On: Voltmeter toggles between preset and actual output when not welding, actual voltage while welding.

Remote On/Off Required: Voltage shown is preset.

Ammeter shows zero.

Adjust optional remote control to desired weld output.

CV Welding

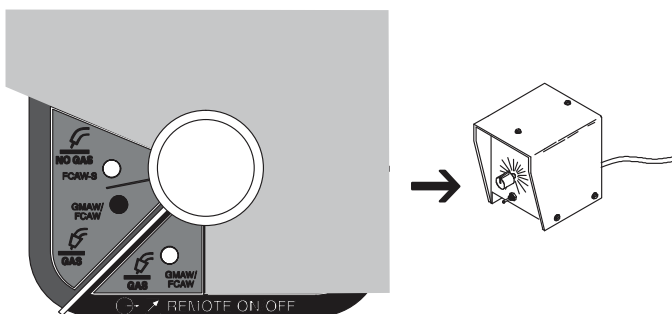

6-11. Operating Engine Block Heater

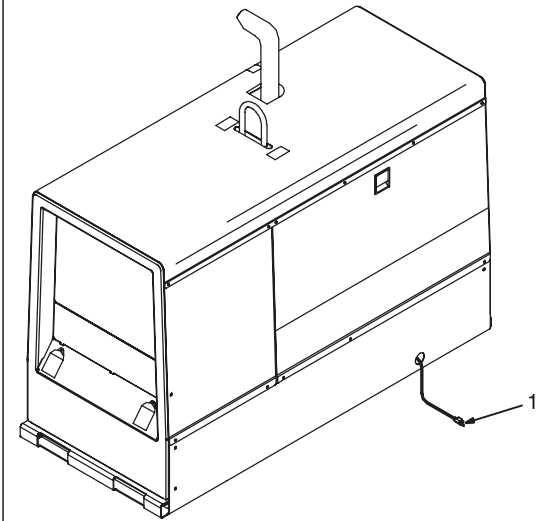
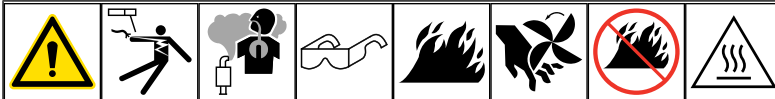

1 Engine Block Heater Plug

Use heater to maintain a constant engine coolant temperature.

To turn on heater, connect heater plug to 120 volts AC receptacle.

⚠ Do not run engine while engine block heater is on.

NOTICE – In extremely cold weather, heater should be connected to power source when engine is warm.

⚠ The area near the engine block heater gets hot.

Disconnect plug to turn off heater.

Heater Specifications		
Engine	Watts	Volts $\pm 10\%$
Deutz	530	120

6-12. Updating Software



Preparing For Software Update

Step 1. Verify the current software version installed. Press and hold the Adjust Control/Select button for 5 seconds, then release to access the Service Menu.

Step 2. Rotate the Adjust Control/Select button to scroll through the menu items until the display reads SOFT WARE.

Step 3. Press the Adjust Control/Select button. The current software revision is displayed.

Step 4. Verify that the USB thumb drive is good. Turn the Engine Control switch to Run, then insert the USB thumb drive. If the display reads USB ACC, the USB thumb drive is good. If the display does not read USB ACC, obtain a different USB thumb drive.

Downloading Software

 Use a PC to download software. Do not use a Mac.

Step 5. Locate the latest firmware to be loaded from MillerWelds.com

Step 6. Click to download the file. When the download is complete, run it.

Step 7. Accept the software licensing agreement.

Step 8. Copy the desired firmware to an empty USB thumb drive.

 Files must be at the top level of the USB and not zipped or inside a folder.

Installing Software

Step 9. Turn Off the welder/generator.

Step 10. Insert the thumb drive into the USB receptacle on the front of the machine.

Step 11. Turn the Engine Control switch to the Run or Run/Idle position.

 Do not start the engine.

Step 12. When the machine has powered up, if valid files exist on the thumb drive, the user is prompted to confirm the start of the download. The Voltmeter/Ammeter display reads: AL? NO.

Step 13. Confirm by rotating the Adjust Control/Select button clockwise to select YES. Then press the Select button.

 After the update has started, do not power down the unit or remove the thumb drive until the update is complete.

During the download, the left meter display indicates the active download with ALLC, ALLW, AL C, or AL W. The right meter display indicates the percentage of the download completed with a number from 0 to 100.

Failures are indicated on the meter display. Correction of failed updates depends on what type of failure occurred.

Step 14. When the update has completed, the control board will reset and all LEDs will turn on for two seconds.

Step 15. Turn Off the welder/generator, then start the engine.

Step 16. Verify the new software revision has installed. Press and hold the Adjust Control/Select button for 5 seconds, then release to access the Service Menu.

Step 17. Rotate the Adjust Control/Select button to scroll through the menu items until the display reads SOFT WARE..

Step 18. Press the Adjust Control/Select button. The current software revision is displayed.

6-13. Summary File

```

** Firmware Revisions **
Master Comm Processor
App Rev .....: 276588E
App Loader Rev.: 276587E
Launcher Rev...: 276588E
Perforce Changelist - App.....: 38682
Perforce Changelist - App Loader: 38682
Perforce Changelist - Launcher..: 38682

```

```

Master Weld Processor
App Rev .....: 276593E
App Loader Rev.: 276591E
Launcher Rev...: 276590E
Perforce Changelist - App.....: 38682
Perforce Changelist - App Loader: 38682
Perforce Changelist - Launcher..: 38682

```

```

Slave Comm Processor
App Rev .....: 276588E
App Loader Rev.: 276587E
Launcher Rev...: 276586B
Perforce Changelist - App.....: 38682
Perforce Changelist - App Loader: 38682
Perforce Changelist - Launcher..: 37243

```

```

Slave Weld Processor
App Rev .....: 276593E
App Loader Rev.: 276591E
Launcher Rev...: 276590B
Perforce Changelist - App.....: 38682
Perforce Changelist - App Loader: 38682
Perforce Changelist - Launcher..: 37243

```

```

** Usage **
Side A:

```

Process	Arc Count	Arc Time
Carbon Arc Gouge	0	0h 0m 0s
Lift-Arc TIG	0	0h 0m 0s
TIG Remote	0	0h 0m 0s
Stick Remote	0	0h 0m 0s
MIG Remote Solid	0	0h 0m 0s
MIG Solid	0	0h 0m 0s
MIG Flux-core	0	0h 0m 0s
Stick XX18	27	15h 40m 54s
Stick XX10	3709	126h 5m 45s
TIG AutoCrater	0	0h 0m 0s
Smart Feeder	0	0h 0m 0s
Totals	3736	141h 46m 39s

```
Side B:
```

Process	Arc Count	Arc Time
Carbon Arc Gouge	0	0h 0m 0s
Lift-Arc TIG	0	0h 0m 0s
TIG Remote	0	0h 0m 0s
Stick Remote	0	0h 0m 0s
MIG Remote Solid	0	0h 0m 0s
MIG Solid	0	0h 0m 0s
MIG Flux-core	0	0h 0m 0s
Stick XX18	1747	61h 51m 45s
Stick XX10	6694	225h 13m 0s
TIG AutoCrater	0	0h 0m 0s
Smart Feeder	0	0h 0m 0s
Totals	8441	287h 4m 45s

```

** Temperatures **
IGBT1 Module .....: 22°C
IGBT2 Module .....: 22°C

```

```

**Error Code Log**
Most Recent Errors:
S/W BLD
S/W ERR
OMMLOSS
IAX POWR

```

Error List	Count
IAX POWR	1
CHEKREMT	0
S/W ERR	1
OMMLOSS	1
IGBT1SHT	0
IGBT1OPN	2
IGBT2SHT	0
IGBT2OPN	2
IGBTTEMP	0
S/W BLD	3

- 1 Summary File, Dual Operator Units
- 2 Summary File, Single Operator Units

Each time a USB stick is inserted in the USB receptacle, a summary file is saved to the USB stick as SummaryFile.txt.

"USB ACC" will display as the file is written. File is complete when display no longer shows "USB ACC."

The summary file provides diagnostic and weld information.

Status Summary

```

** Firmware Revisions **
Master Comm Processor
App Rev .....: 276588A
App Loader Rev.: 276587A
Launcher Rev...: 276586A
Perforce Changelist - App.....: 36878
Perforce Changelist - App Loader: 36755
Perforce Changelist - Launcher..: 36755

```

```

Master weld Processor
App Rev .....: 276589A
App Loader Rev.: 276591A
Launcher Rev...: 276590A
Perforce Changelist - App.....: 36855
Perforce Changelist - App Loader: 36855
Perforce Changelist - Launcher..: 36855

```

```

** Usage **

```

Process	Arc Count	Arc Time
Carbon Arc Gouge	2	0h 2m 12s
Lift-Arc TIG	10	2h 16m 6s
TIG Remote	1	0h 2m 31s
Stick Remote	19	8h 51m 41s
MIG Remote Solid	0	0h 0m 0s
MIG Solid	102	107h 41m 28s
MIG Flux-core	0	0h 0m 0s
Stick XX18	81	96h 8m 4s
Stick XX10	3	0h 49m 37s
TIG AutoCrater	0	0h 0m 0s
Totals	218	215h 51m 39s

```

** Temperatures **
IGBT1 Module .....: 61°C
IGBT2 Module .....: 61°C

```

```

**Error Code Log**
Most Recent Errors:
S/W BLD
IGBT2OPN
S/W ERR

```

Error List	Count
MAX POWR	0
CHEKREMT	0
IGBT1SHT	0
IGBT1OPN	15
IGBT2SHT	0
IGBT2OPN	15
IGBTTEMP	0
S/W ERR	5
S/W BLD	5

6-14. Fuel/Hour Gauge Descriptions

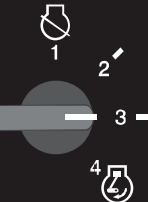
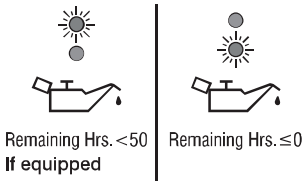
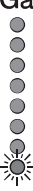
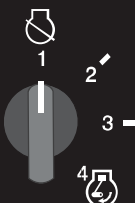
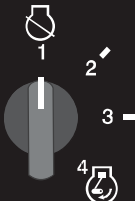
Fuel, Hour, and Engine Shutdown Descriptions		
LH Display HOUR	RH Display 0000	ENGINE HOURS: To display engine hours while the engine is off, place Engine Control switch in position "2". 
LH Display OIL	RH Display 0499	OIL CHANGE INTERVAL: To display hours remaining before oil change is due, place Engine Control switch in position "3" (with engine off). 
Service Indicator Lights 		OIL CHANGE DUE: Service indicator light will illuminate Red when service is due. To Reset: Press and hold Control/Select knob for 5 sec. to access service menu, scroll to RSET, press knob, scroll to select YES, press knob to reset.
Fuel Gauge*  <small>*If equipped</small>		LOW FUEL PREWARNING: Last LED in fuel gauge is illuminated steady. LOW FUEL: Fuel level low when last LED in fuel gauge blinks.
LH Display* LOW	RH Display* FUEL	NO FUEL: Engine shuts down before fuel runs out. Display shows "LOW FUEL." To Reset: Refuel.
LH Display OIL	RH Display PRES	LOW OIL PRESSURE: Engine shuts down when oil pressure is low. Display shows "OIL PRES." To Reset: Place Engine Control switch in OFF position. 
LH Display* H2O	RH Display* TEMP	HIGH COOLANT TEMP: Engine shuts down when coolant temperature is high. Display shows "H2O TEMP." To Reset: Place Engine Control switch in OFF position. 
<p>Note: Switch positions are numbered to illustrate that there are four switch positions. Actual graphics on front panel will vary.</p>		

278439-B

6-15. Associating ArcReach® Devices (ArcReach Models Only)



⚠ Stop engine.

NOTICE – Do not exceed machine duty cycle.

Associating ArcReach Device To Engine Driven Welder/Generator

Make connections between welder/generator and ArcReach device. See Owner's Manual for ArcReach device for typical connection diagrams.

The welder/generator has the ability to associate automatically with an ArcReach device at power up. The Process/Contactor switch must be set to an Output ON mode to associate with an ArcReach device.

See the ArcReach device Owner's Manual to associate the device to the welder/generator.

When the association process is complete, the In Use light will be illuminated. Depending on the capabilities of the ArcReach device, the Process/Contactor switch, Adjust Control/Select button, and Arc Control adjustment may be overridden.

The following ArcReach accessories are compatible with this welder/generator:

ArcReach Stick/TIG Remote For Stick Or TIG Welding

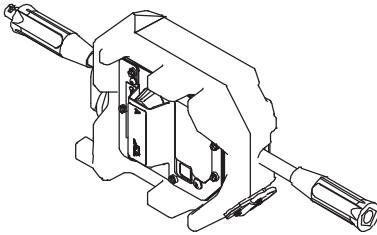

When welder/generator is associated with Stick/TIG Remote:

SMAW processes: Amperage, Electrode Type, and Arc Control settings are adjusted on the remote.

GTAW and CAC-A processes: Amperage settings are adjusted on the remote.

ArcReach SuitCase Feeders For MIG Or FCAW Welding

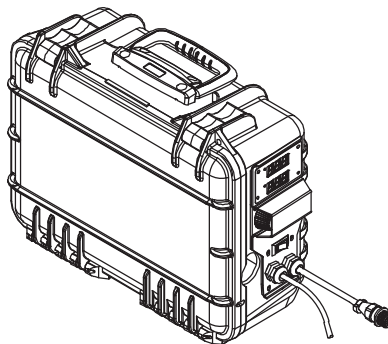

When welder/generator is associated with SuitCase ArcReach feeder, voltage and wire feed settings are adjusted on the feeder.

ArcReach Smart Feeder For Advanced Wire Processes



274460-A / 266206-D

When welder/generator is associated with Smart Feeder, all controls switch to the feeder, and the display reads SMRT ACC.

👉 When using this ArcReach device, the engine will stay at RUN speed.

6-16. Optional Air Dryer Operation (Air Pak Models)

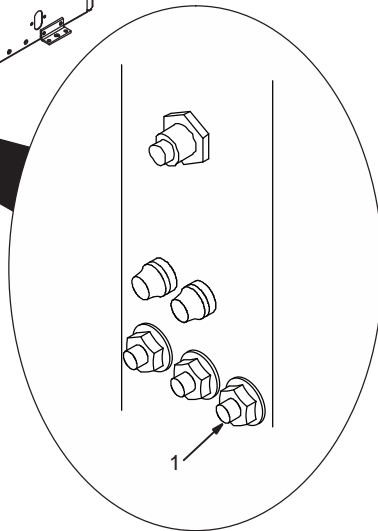
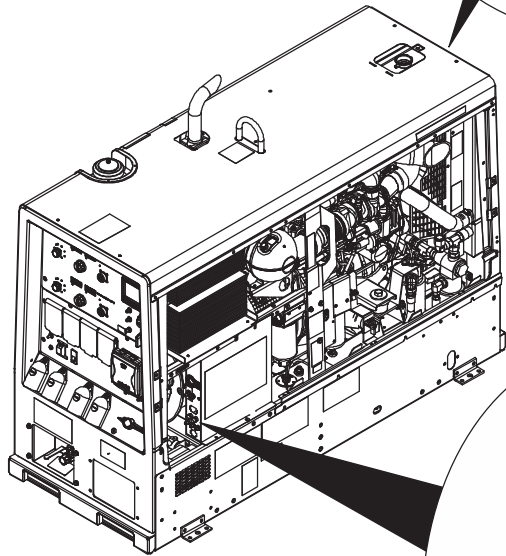
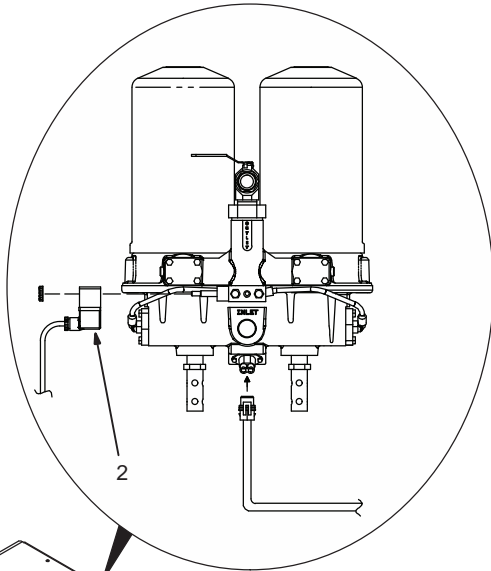

The air dryers blow out (purge) moisture and debris when the air compressor is being used. The air dryer heaters operate whenever the welder/generator is running.

See the supplied air dryer Owner's Manual for air dryer maintenance and service information.

When battery access is required, disconnect and remove the air dryer assembly as described in Section 8-13.

1 Circuit Breaker CB14

CB14 protects the dryer heaters from damage due to overload. If CB14 opens, the heaters do not work and the dryer does not discharge moisture in cold weather.

Press button to reset circuit breaker CB14.

When a circuit breaker opens, it usually indicates a more serious problem exists. Contact a Factory Authorized Service Agent.

Start engine, and turn on air compressor. Check fittings for air leaks and tighten fittings if necessary.

2 Timer Control LED

Verify dryer solenoid is functioning by listening for dryer canisters to purge, or by checking solenoid LED. LED lights at start-up and every two minutes when the canisters automatically purge.

907 535-2 / 803 228 / 803 229

SECTION 7 – OPERATING AUXILIARY EQUIPMENT

7-1. Generator Power Receptacles

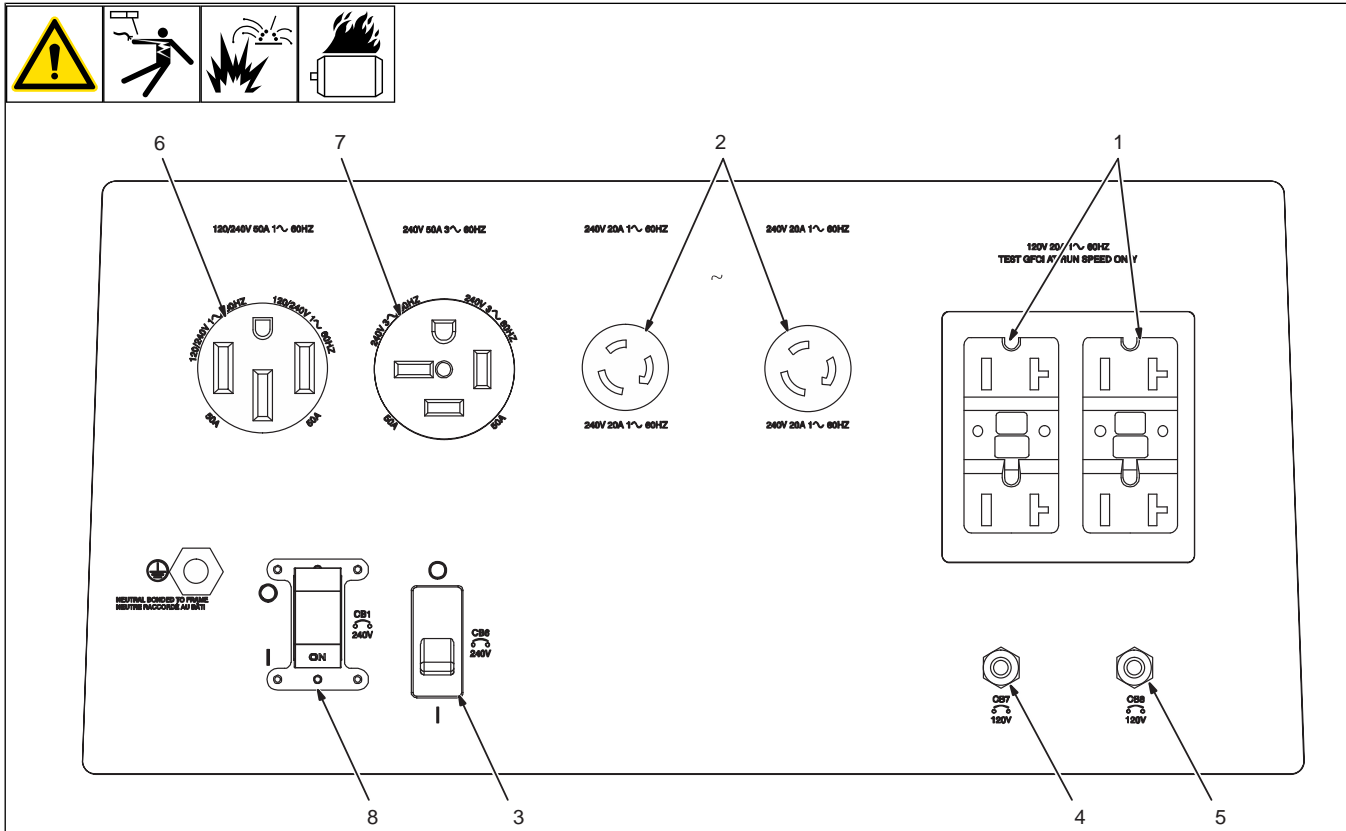

271 858-B

Single-Phase Generator Power

- ⚠ Use GFCI protection when operating auxiliary equipment. If unit does not have GFCI receptacles, use GFCI-protected extension cord. Do not use GFCI receptacles to power life support equipment.**
- ⚠ Unplug power cord before attempting to service accessories or tools.**

- 1 120 V 20 A AC GFCI Receptacle GFCI1 Or GFCI2
- ⚠ Test GFCI monthly. See Section 7-2 for GFCI information and for resetting and testing procedures.**

- 2 240 V 30 A AC Twistlock Receptacle RC1 or RC2

Receptacles supply 60 Hz single-phase power at weld/power speed.

- 3 Supplementary Protector CB6
- 4 Supplementary Protector CB7
- 5 Supplementary Protector CB8

CB6 protects RC1 and RC2, and the generator winding from overload. If CB6 opens,

RC1, RC2, GFCI1 and GFCI2 do not work. Place switch in On position to reset.

CB7 protects GFCI1 from overload. If CB7 opens, GFCI1 does not work. Press button to reset.

CB8 protects GFCI2 from overload. If CB8 opens, GFCI2 does not work. Press button to reset.

☞ If a supplementary protector continues to open, contact Factory Authorized Service Agent.

☞ Generator power is not affected by weld output.

Maximum output is 2.4 kVA/kW from GFCI1 and 4 kVA/kW from RC1. Maximum output from all receptacles is 4 kVA/kW.

EXAMPLE: If 13 A is drawn from RC1, only 7 A is available at GFCI1:

$$(240\text{ V} \times 13\text{ A}) + (120\text{ V} \times 7\text{ A}) = 4.0\text{ kVA/kW}$$

- 6 120/240 V 50 A Receptacle RC5

RC5 is connected to the three-phase generator and supplies 60 Hz single-phase power at weld/power speed. Maximum output from RC5 is 12 kVA/kW. Power available at RC5 is reduced when welding.

Three-Phase Generator Power

- 7 240 V 50 A Three-Phase Receptacle RC4

RC4 is connected to the three-phase generator and supplies 60 Hz three-phase power at weld/power speed. Maximum output from RC4 is 20 kVA/kW. Power available at RC4 is reduced when welding.

- 8 Supplementary Protector CB1

Supplementary protector CB1 protects three-phase receptacle RC4, single-phase receptacle RC5, and the load wires from overload. If CB1 opens, all generator output stops and the receptacles do not work.

7-2. GFCI Receptacle Information, Resetting, And Testing

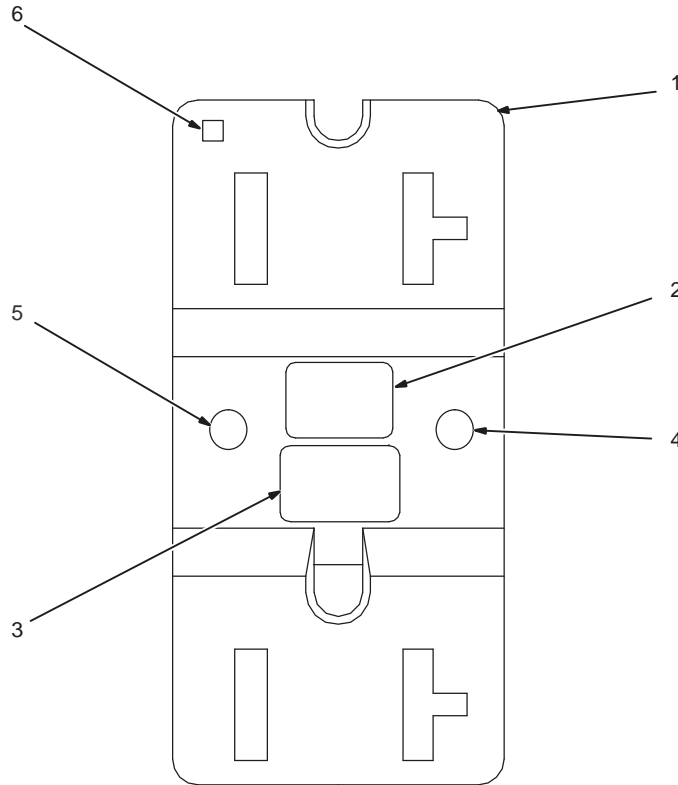

- ⚠ Use GFCI protection when operating auxiliary equipment. If unit does not have GFCI receptacles, use GFCI-protected extension cord. Do not use GFCI receptacle to power life support equipment.**
- ⚠ Unplug power cord before attempting to service accessories or tools.**

- 1 120 V 20 A AC GFCI Receptacle
- 2 GFCI Receptacle Test Button
- 3 GFCI Receptacle Reset Button
- 4 Red GFCI Indicator Light (LED)
- 5 Green GFCI Indicator Light (LED)
- 6 Alternate Location For Red And Green Indicator LEDs

☞ Red and Green indicator lights may be combined in a single LED.

☞ Orientation of receptacle may be different in other applications.

GFCI Receptacles

GFCI receptacles protect the user from electric shock if a ground fault occurs in equipment connected to the receptacle. A ground fault occurs when electrical current takes the shortest path to ground (which could be through a person) rather than follow its intended safe path.

If a ground fault is detected, the GFCI Reset button pops out, and the circuit opens to disconnect power to the faulty equipment. A GFCI receptacle does not protect against circuit overloads, short circuits, or shocks not related to ground faults. Reset and test GFCI receptacle according to the following procedures.

A solid green LED indicates power to the GFCI. A solid red LED indicates that the GFCI has been tripped.

Resetting/Testing GFCI Receptacle

- ⚠ Test GFCI monthly.**
- ⚠ If Red LED blinks, stop using GFCI receptacle and have a Factory Authorized Service Agent replace it.**
- ⚠ Extension cords with bad insulation or of extended length can allow enough leakage current to trip the GFCI circuit. Reset and test as follows.**

Resetting GFCI Receptacles

If a GFCI fault occurs, stop engine and disconnect equipment from GFCI receptacle. Check for damaged or wet tools, cords, plugs, etc. connected to the receptacle. Start engine, place engine control switch in RUN position, and press GFCI Reset button. Reconnect equipment to GFCI receptacle. If GFCI Reset button pops out again, check the equipment and repair or replace if faulty.

Testing GFCI Receptacles

Start engine and place engine control switch in Run position. Press the GFCI Test button. The GFCI Reset button should pop out.

Press the GFCI Reset button.

Have a Factory Authorized Service Agent replace GFCI if any of the following occur:

- GFCI does not trip when tested**
- Red LED blinks**
- GFCI does not reset.**

SECTION 8 – MAINTENANCE

8-1. Maintenance Label

DEUTZ DIESEL ENGINE D2.9L4/TD2.9L4

12 V BCI 31
925 A @ 0° F (-18° C)

8 h std.

USE EXTENDED LIFE COOLANT ONLY.
Consult engine owner's manual.



8 h std.

MILLER 192939 (optional)
Donaldson P822769

MILLER 192938**
Donaldson P822768

250 h std.

AIRPAK only:
MILLER 253944
Dayco 5080725



500 PRO:
MILLER 260572
Deutz 0434 3181

800 DUOPRO:
MILLER 265120
Goodyear AX52

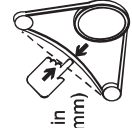

250 h std.

For API oil ratings, consult engine owner's manual.

8.5 qt (8 L)
Check engine dipstick.





DO NOT PRE-FILL FILTERS.
NOTICE: Use only approved low ash oil. Use of other oils may cause emission equipment failure and void warranty.

** FILTER KIT 262459 contains noted filters.

500 h std.

MILLER 067265**
Deutz 117-4416

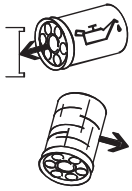

250 h std.

Primary Filter
MILLER 255764**
Deutz 0413 0241

Secondary Filter
MILLER 255765**
Deutz 0413 1532

DO NOT PRE-FILL FILTERS.
Consult owner's manual for air bleeding fuel system.



2000 h / 2 yr std.

16 qt (15.2 L)

USE EXTENDED LIFE COOLANT ONLY.
Consult engine owner's manual.

500 h std.

MILLER 192939 (optional)
Donaldson P822769

MILLER 192938**
Donaldson P822768

8 h std.

USE EXTENDED LIFE COOLANT ONLY.
Consult engine owner's manual.



8 h std.

MILLER 192939 (optional)
Donaldson P822769

MILLER 192938**
Donaldson P822768

250 h std.

AIRPAK only:
MILLER 253944
Dayco 5080725



500 PRO:
MILLER 260572
Deutz 0434 3181

800 DUOPRO:
MILLER 265120
Goodyear AX52

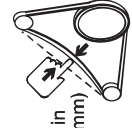

250 h std.

For API oil ratings, consult engine owner's manual.

8.5 qt (8 L)
Check engine dipstick.





DO NOT PRE-FILL FILTERS.
NOTICE: Use only approved low ash oil. Use of other oils may cause emission equipment failure and void warranty.

** FILTER KIT 262459 contains noted filters.

500 h std.

MILLER 067265**
Deutz 117-4416

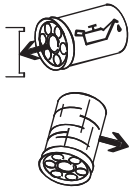

250 h std.

Primary Filter
MILLER 255764**
Deutz 0413 0241

Secondary Filter
MILLER 255765**
Deutz 0413 1532

DO NOT PRE-FILL FILTERS.
Consult owner's manual for air bleeding fuel system.



2000 h / 2 yr std.

16 qt (15.2 L)

USE EXTENDED LIFE COOLANT ONLY.
Consult engine owner's manual.

500 h std.

MILLER 192939 (optional)
Donaldson P822769

MILLER 192938**
Donaldson P822768

OM-279640 Page 56





8-2. Cleaning Unit

Clean unit exterior, including stainless steel if so equipped, frequently to prevent rust.

NOTICE – Use of a power washer is acceptable; however, cover or avoid electrical parts and the Engine Control Unit (ECU) located on the lower left side of the center upright.

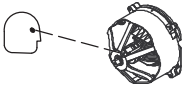
8-3. Routine Maintenance

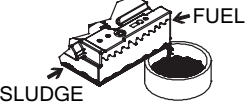
<p>⚠ Stop engine before maintaining.</p> <p>👉 See Engine Manual and Maintenance Label for important start-up, service, and storage information. Service engine more often if used in severe conditions.</p> <p>👉 Recycle engine fluids.</p>					
🕒	✓ = Check	◇ = Change	○ = Clean	☆ = Replace	Reference
Every 8 Hours	 FUEL WATER ✓ Primary Fuel Filter	 ✓ Fuel Level	 ✓ Oil Level	 ○ Oil, Fuel Spills	Engine Manual, Sections 5-6, 8-7, and 9-3
	 ✓ Coolant Level	○ Clean unit exterior, including stainless steel, frequently to prevent rust and corrosion.	 ✓ Air Cleaner Hoses	 ✓ Air Cleaner Element	
Every 100 Hours	 ○ Battery Terminals	 ○ Weld Terminals			Engine Manual
Every 250 Hours	 ☆ Unreadable Labels	 1/2 in. (13 mm) ✓ Fan Belt Tension	 ○ Cooling System	 ✓ ○ Spark Arrestor	Engine Manual
Every 500 Hours	 ◇ Oil, Oil Filter NOTICE – Do not pre-fill oil filters.	NOTICE – Change engine oil and filter after initial 50 to 75 hours of use. See engine manual for oil specifications.	 ◇ Fuel Filters NOTICE – Do not pre-fill fuel filters.	 ✓ ☆ Weld Cables	Section 8-10 and Engine Manual

<p>Every 1000 Hours</p>	 <p>✓ ○ Slip Rings* ✓ ☆ Brushes*</p>	 <p>○ Inside Unit</p>	 <p>FUEL SLUDGE ○ Drain Sludge</p>		<p>Sections 8-4 and 8-10 and Engine Manual</p>
<p>Every 2000 Hours</p>	 <p>☆ Coolant</p>	<p>NOTICE – Use <i>extended life coolant</i> only. See engine manual for coolant specifications.</p>			

*To be done by factory authorized service agent.







DEUTZ Service: <http://www.deutzamericas.com>

To ensure rapid, efficient service support, you should initially contact your nearest DEUTZ service distributor or dealer. They are staffed with highly qualified parts, service and engine specialists to handle your different needs.

The DEUTZ Service Desk enhances this support and can be contacted by completing and submitting the Service Support Form. Customers in the US and CANADA can also contact the service desk by calling our toll free number, 1-800-241-9886.

Our normal hours of operation are from 8:00 AM to 6:00 PM Monday through Friday EST. You may contact our on call service 24 hours, 7 days a week. We ask that when you contact us, please have available or provide specific engine information (serial number, model number etc.) as shown on the Service Support Form.

8-4. Checking Generator Brushes

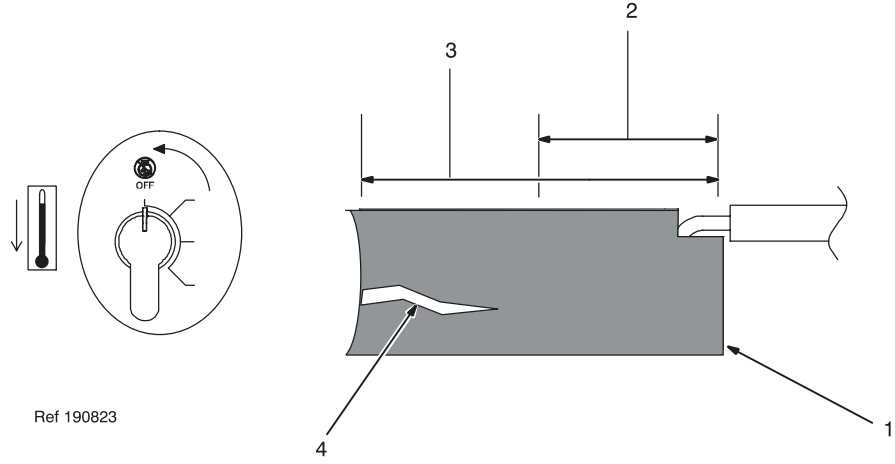

Ref 190823

⚠ Stop engine and let cool.

- 1 Generator Brush
- 2 Minimum Length: 5/8 in. (16 mm)
- 3 New Length: 1–1/4 in. (32 mm)
- 4 Damaged Brush

Mark and disconnect leads at brushholder cap. Remove brushes.

Replace brushes if damaged or if brush material is at or near minimum length.

8-5. Battery Replacement

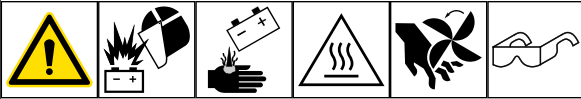

Larger Battery

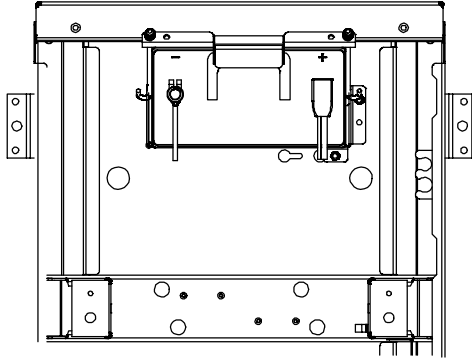

Smaller Battery

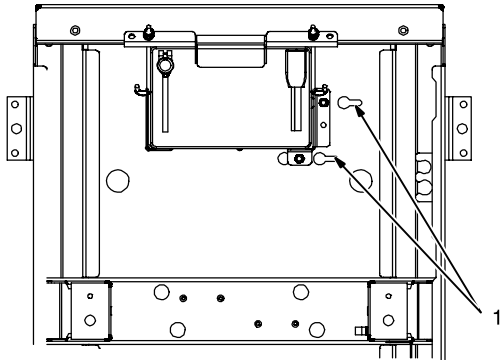

255858

Stop engine.

Shown from top of unit.

1 Battery Locator Bracket Mounting Holes

Access battery as shown in Section 5-4. Disconnect battery.

Remove J-bolts securing battery and remove battery.

Battery locator brackets can be moved to accommodate batteries of different physical sizes.

Install and secure replacement battery.

Connect negative (-) battery cable last.



8-6. Battery Maintenance

Lead acid batteries discharge when stored in any temperature. Units that are stored should have the battery recharged every three months and before being put into service. To preserve optimum battery performance and life, recharge battery in storage when the open-circuit voltage drops to 12.4 volts DC when measured across the battery terminals.

8-7. Servicing Air Cleaner

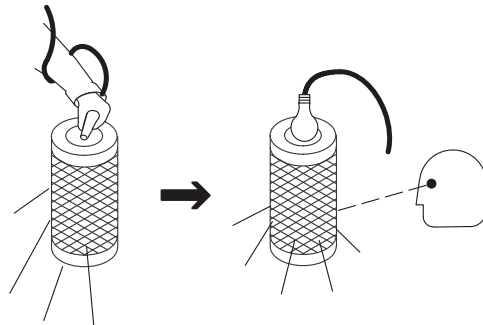
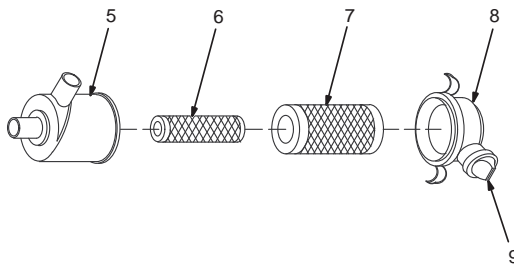
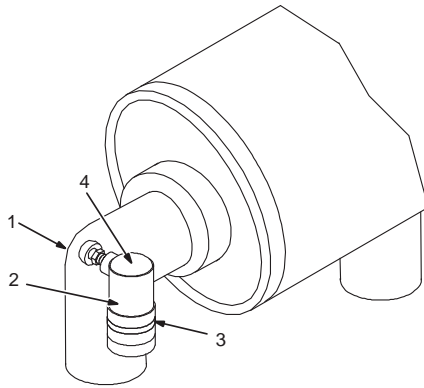
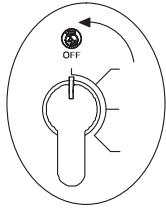

Stop engine.

NOTICE – Do not run engine without air cleaner or with dirty element. Engine damage caused by using a damaged element is not covered by the warranty.

The air cleaner primary element can be cleaned but the dirt holding capacity of the filter is reduced with each cleaning. The chance of dirt reaching the clean side of the filter while cleaning and the possibility of filter damage makes cleaning a risk. Consider the risk of unwarrantable equipment damage when determining whether to clean or replace the primary element.

NOTICE – If you decide to clean the primary element, we strongly recommend installing an optional safety element to provide additional engine protection. **Never clean a safety element.** Replace the safety element after servicing the primary element three times.

- 1 Intake Manifold
- 2 Service Indicator (Optional, Customer Supplied)
- 3 Service Indicator Window
- 4 Service Indicator Reset Button

Service air cleaner element if red band appears in window. A green band means air cleaner is okay. Press button to reset indicator.

Clean or replace primary element if dirty (see note above before cleaning). Replace primary element if damaged. Replace primary element yearly or after six cleanings.

- 5 Housing
- 6 Safety Element (Optional)
- 7 Primary Element
- 8 Cover
- 9 Dust Ejector

To clean air filter

Wipe off cover and housing. Remove cover and dump out dust. Remove element (s). Wipe dust from inside cover and housing with damp cloth. Reinstall safety element (if present). Reinstall cover.

Do not clean housing with air hose.

Clean primary element with compressed air only.

Air pressure must not exceed 100 psi (690 kPa). Use 1/8 in (3 mm) nozzle and keep nozzle at least 2 in (51 mm) from inside of element. Replace primary element if it has holes or damaged gaskets.

Reinstall primary element and cover (dust ejector down).

8-8. Engine Speed Adjustment

Engine functions are controlled by the engine ECU. Tampering with the engine ECU may void engine warranty. Contact engine Factory Authorized Service Agent for engine adjustments.

8-9. Oil Specifications

Synthetic Oil Viscosity Chart

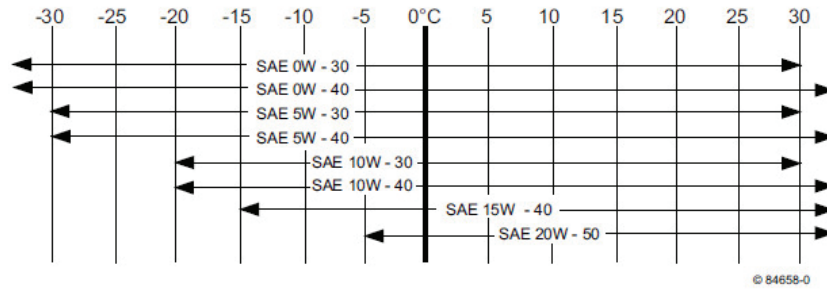

For any normal oil change interval, any engine oil with a CJ-4 and low ash rating may be used. After the initial run-in period, synthetic oil may be used to replace oil shipped in the engine.

Synthetic lubricating oils have a better temperature and oxidation stability, better soot dispersal properties, and a relatively low cold viscosity making them suitable for use in arctic temperatures.

Use table to select appropriate product.

All products listed comply with DQC IV-10LA and have Base Number (TBN) ≥ 9 mg KOH/g

For additional DQC IV-10LA oil products, see www.deutz.com/en/service/maintenance/operating-liquids.

Manufacturer	Product Name	SAE Class/Weight
Addinol	Addinol Extra Truck MD 1049 LE	10W-40
Aral AG	Aral Mega Turboral LA 10W-40	10W-40
BP Plc.	BP Vanellus Max Eco 10W-40	10W-40
Castrol Limited	Castrol Enduron Low SAPS 10W-40	10W-40
Chevron Global Lubricants	Chevron Delo 400 LE Synthetic 5W-30	5W-30
	Texaco Ursa Ultra XLE 5W-30	5W-30
ExxonMobil Corp.	Mobil Delvac XHP LE 10W-40	10W-40
Fuchs Petrolub AG	Titan Cargo Maxx 5W-30	5W-30
	Titan Cargo Maxx 10W-40	10W-40
Hessol Lubrication GmbH	Hessol Dimo Extra	10W-40
Lukoil Lubricants	Lukoil Avantgarde Professional LS	5W-30
OMV	OMV Truck Blue ET SAW 10W-40	10W-40
PHI Oil GmbH	Motodor LSP Gold 5W-30	5W-30
Repsol	Repsol Ecotech Premium Low SAPS W-40	10W-40
SRS Schmierstoff Vertrieb GmbH	SRS Cargolub TLS	5W-30
Shell International	Shell Rimula R6 LM	10W-40
Unil Opal	Pallas 900	10W-40
Valvoline	Valvoline ProFleet LS SAE 10W-40	10W-40

8-10. Servicing Fuel And Lubrication Systems

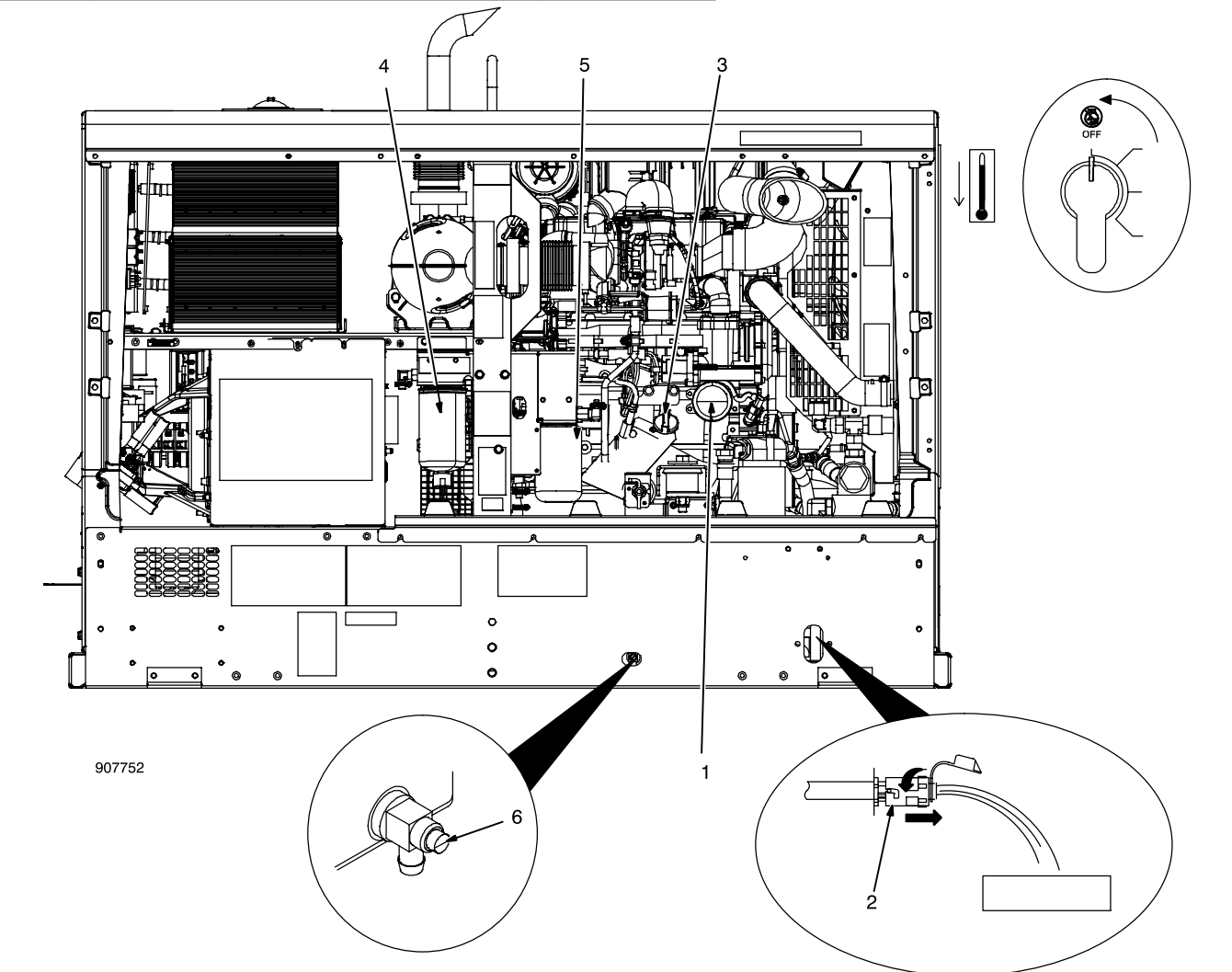

907752

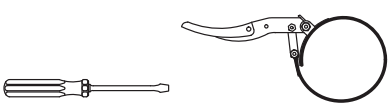

⚠ Stop engine and let cool.

⚠ After servicing, start engine and check for fuel leaks. Stop engine, tighten connections as necessary, and wipe up spilled fuel.

- 1 Oil Filter
- 2 Oil Drain Valve And Hose
- 3 Oil Fill Cap
- 4 Primary Fuel Filter
- 5 Secondary Fuel Filter
- 6 Fuel Tank Sludge Drain Valve

To change oil and filter:

Route oil drain hose and valve through hole in base. See engine manual and engine maintenance label for oil/filter change information.

To replace fuel filters:

For primary fuel filter, disconnect water sensor connection.

Turn filter counterclockwise. Remove filter.

Apply thin coat of fuel to gasket on new filter. Do not prefill filter. Install filter and turn clockwise. For primary fuel filter, reconnect water sensor. Bleed air from fuel system according to engine manual.

Inspect fuel line, and replace if cracked or worn.

Close doors.

To reset service reminder intervals shown on the Engine Display, see Sections 13-12 and 13-13.

To drain sludge from fuel tank:

⚠ Beware of fire. Do not smoke and keep sparks and flames away from drained fuel. Dispose of drained fuel in an environmentally safe manner. Do not leave unit unattended while draining fuel tank.

⚠ Properly lift unit and secure in a level position. Use adequate blocks or stands to support unit while draining fuel tank.

Attach 1/2 ID hose to drain valve. Put metal container under drain, and use screwdriver to open sludge drain valve. Close valve when sludge has drained. Remove hose.

8-11. Engine/Generator Overload Protection

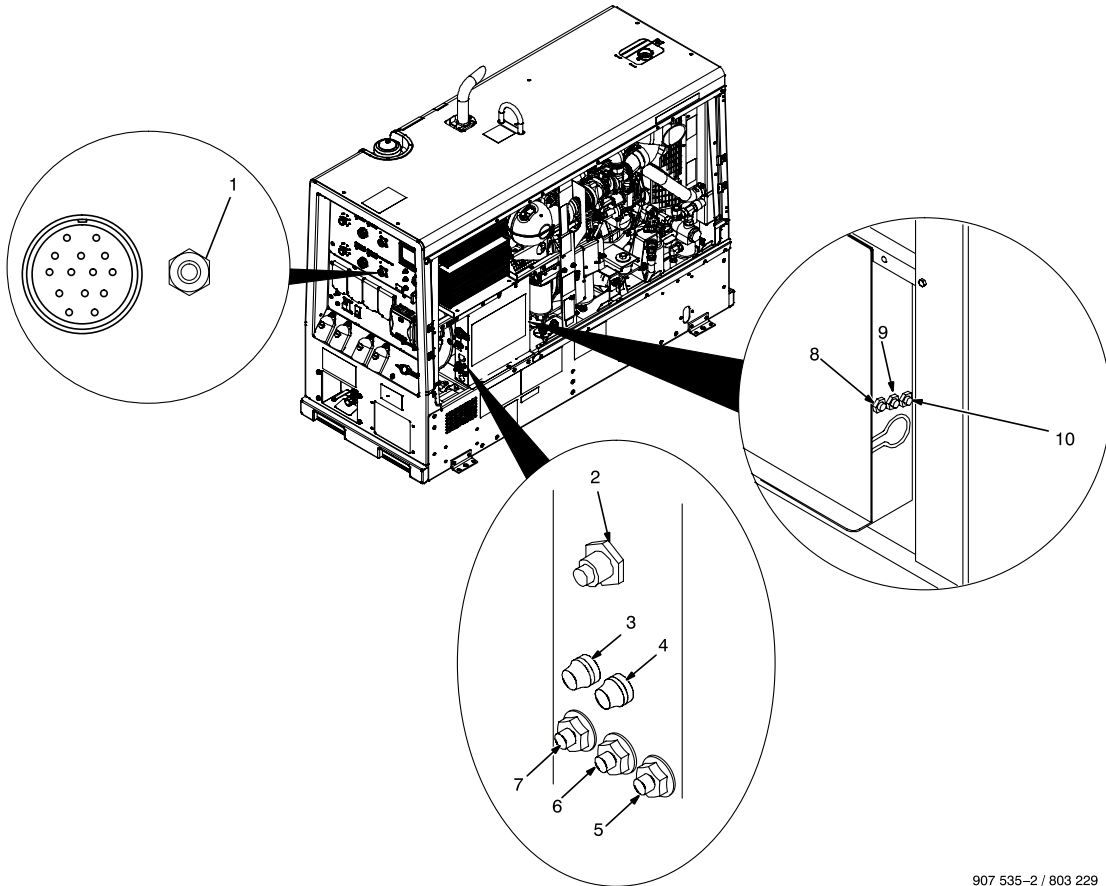

907 535-2 / 803 229

Stop engine.

When a supplementary protector, circuit breaker or fuse opens, it usually indicates a more serious problem exists. Contact Factory Authorized Service Agent.

See Section 9-4 for air compressor overload protection. See Section 6-16 for air dryer overload protection.

1 Supplementary Protector CB9/CB29

CB9 and CB29 protect the 24 volt AC output to remote receptacles. If CB opens, weld output and 24 volt output to remote receptacle stops.

2 Supplementary Protector CB15

Compressor overload protection, see Section 9-4.

3 Fuse F1

4 Fuse F2

F1 and F2 protect the stator exciter winding from overload. If F1 opens, weld and generator power is low or stops entirely. If F2 opens, weld output is low or stops entirely. 4 kVA/kW generator power is still available.

5 Supplementary Protector CB14

Air dryer overload protection, see Section 6-16.

6 Supplementary Protector CB3

7 Supplementary Protector CB4

CB3 protects the engine weld control circuit. If CB3 opens, weld output stops, meters will be blank; however, generator power is still available.

CB4 protects the field flashing circuit. If CB4 opens, the generator may not excite at start-up and weld and generator power output may not be available.

8 Supplementary Protector CB2

CB2 protects the engine control circuit. If CB2 opens, the engine does not crank.

9 Supplementary Protector CB11

CB11 protects the 12 volts DC supply to the engine ECU. If CB11 opens, the engine will stop. Since the ECU generates error messages, no error message may appear on the Engine Display.

10 Supplementary Protector CB12

CB12 protects the fuel pump circuit. If CB12 opens, the fuel pump does not work and the unit will stop.

11 Circuit Breaker CB10 (Not Shown)

CB10 protects the engine battery circuit. If CB10 opens, the engine will not crank. CB10 automatically resets when the fault is corrected.

12 Circuit Breaker CB13 (Not Shown)

CB13 protects the glow plug circuit. If CB13 opens, the glow plug will not operate. CB13 automatically resets when the fault is corrected.

8-12. Voltmeter/Ammeter Error Displays



IGBT

TEMP

Display Example

Use the Voltmeter/Ammeter error displays to diagnose and correct fault conditions.

☞ When an error is displayed, normally weld output has stopped but generator power output may be okay.

☞ To reset error displays, stop unit and then restart. See below to reset CHEK REMT display.

Error Display	Description
CHEK REMT	Indicates a remote device connected to the Remote Receptacle may be faulty. Clear fault by stopping and restarting the unit, or by turning Process/Contactor switch to another position. If problem continues, have Factory Authorized Service agent check the remote device and main control board PC1.
IGBT 1SHT	Indicates the thermistor in IGBT module 1 has shorted. Have Factory Authorized Service Agent check unit.
IGBT 1OPN	Indicates the thermistor in IGBT module 1 is open. Have Factory Authorized Service Agent check unit.
IGBT 2SHT	Indicates the thermistor in IGBT module 2 has shorted. Have Factory Authorized Service Agent check unit.
IGBT 2OPN	Indicates the thermistor in IGBT module 2 is open. Have Factory Authorized Service Agent check unit.
IGBT TEMP	Indicates an IGBT module has overheated. If this display is shown, check generator cooling system and/or reduce duty cycle. Keep engine access door closed when running unit to maintain proper cooling airflow past module. Allow unit to cool before restarting. If problem continues, have Factory Authorized Service Agent check unit.
MAX POWR	Engine power limit exceeded, causing weld output to be temporarily reduced. Error clears after 5 seconds.
S/W ERR	Software version mismatch occurred. Reload software update. If error does not clear, have Factory Authorized Service Agent check unit.
S/W BLD	Software build mismatch occurred. Reload software update. If error does not clear, have Factory Authorized Service Agent check unit.
BOOT ERR	Slave processor(s) not reporting versions. Reload software.

8-13. Removing Optional Air Dryer For Service

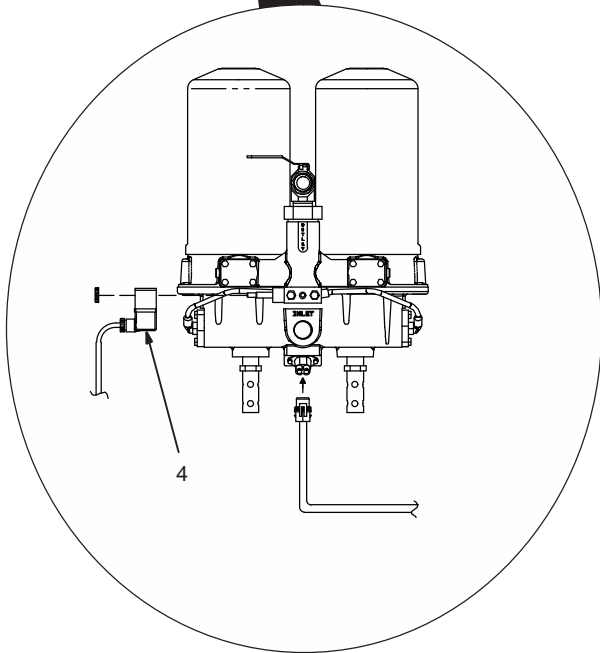
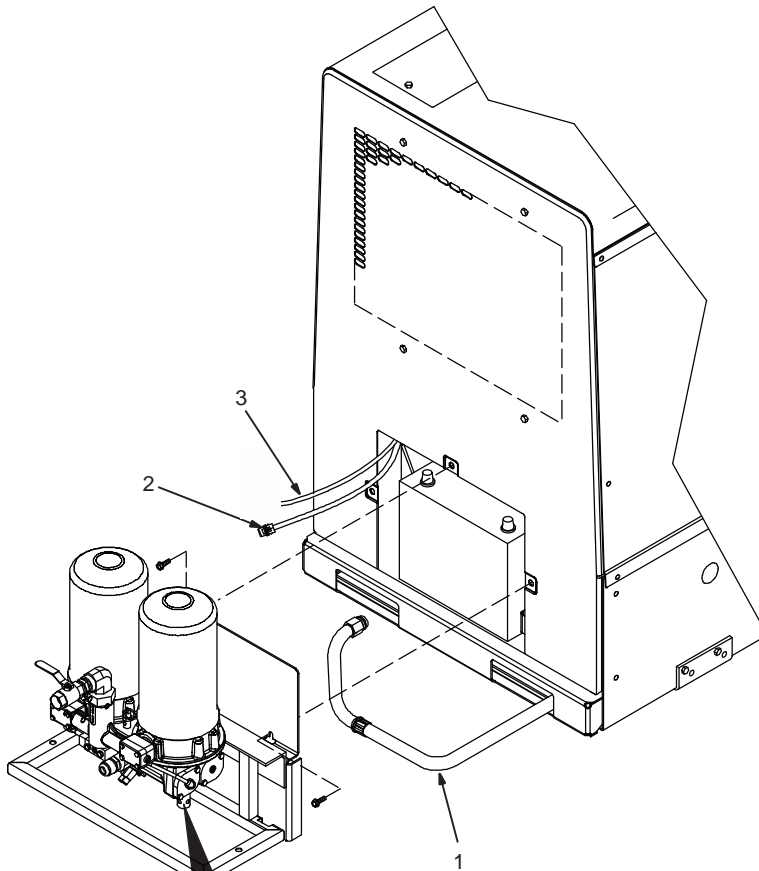
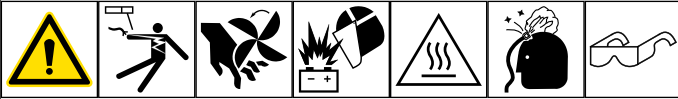

Follow this procedure whenever the air dryer must be removed to gain access to the battery.

- 1 Air Line
- 2 Timer Control Cable
- 3 Air Dryer Heater Plug
- 4 Solenoid LED

Disconnect air line from dryer assembly bottom inlet.

Disconnect heater cable from bottom of air dryer assembly.

Loosen hardware securing battery access panel to rear panel. Carefully pull access panel/air dryer assembly away from unit rear panel. Support dryer assembly to relieve strain on timer control cable.

Disconnect battery negative (-) cable. When service is complete, reconnect battery negative (-) cable.

Reinstall battery access panel/air dryer assembly. Reconnect air dryer heater cable.

Reconnect air line to dryer bottom inlet.

Final-tighten all hardware, and air line and air dryer fittings.

Start engine, and turn on air compressor. Check fittings for air leaks and tighten fittings if necessary.

Verify dryer solenoid is functioning by listening for dryer canisters to purge, or by checking solenoid LED. LED lights at start-up and every two minutes when the canisters automatically purge.

SECTION 9 – AIR COMPRESSOR MAINTENANCE (AIR PAK MODELS)

9-1. Air Compressor Maintenance Label

The air compressor normally requires service at the intervals listed in the maintenance schedule if used in a clean, dry environment. The compressor will require service more often if used in dirty, humid conditions.

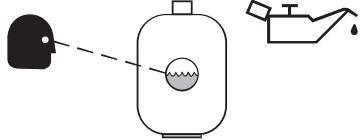
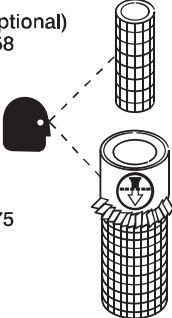
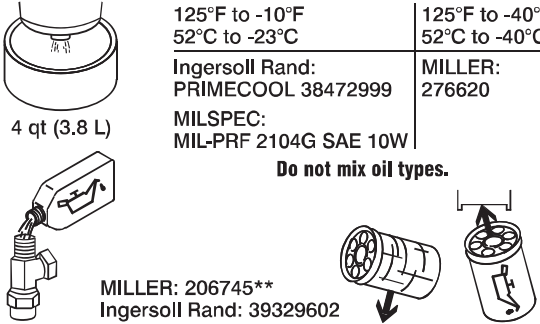
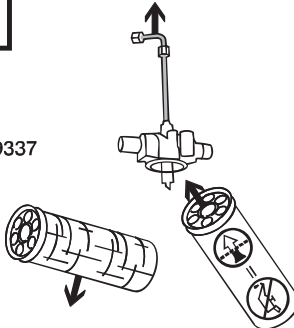
INGERSOLL RAND AIR COMPRESSOR 		500 h / 6 m std.					
8 h std. 	<p style="text-align: center;">Listed oil and filters must be used to maintain 3 yr warranty.</p> <table border="1" style="width: 100%; border-collapse: collapse;"> <tr> <td style="width: 50%; text-align: center;"> 125°F to -10°F 52°C to -23°C </td> <td style="width: 50%; text-align: center;"> 125°F to -40°F 52°C to -40°C </td> </tr> <tr> <td style="text-align: center;"> Ingersoll Rand: PRIMECOOL 38472999 MILSPEC: MIL-PRF 2104G SAE 10W </td> <td style="text-align: center;"> MILLER: 276620 </td> </tr> </table> <p style="text-align: center;">Do not mix oil types.</p>			125°F to -10°F 52°C to -23°C	125°F to -40°F 52°C to -40°C	Ingersoll Rand: PRIMECOOL 38472999 MILSPEC: MIL-PRF 2104G SAE 10W	MILLER: 276620
125°F to -10°F 52°C to -23°C	125°F to -40°F 52°C to -40°C						
Ingersoll Rand: PRIMECOOL 38472999 MILSPEC: MIL-PRF 2104G SAE 10W	MILLER: 276620						
250 h std. MILLER: 197679 (optional) Donaldson: P822858 WIX: 42985 MILLER: 197676** Donaldson: P821575 WIX: 46438 	 <p style="text-align: center;">MILLER: 206745** Ingersoll Rand: 39329602</p>						
** FILTER KIT 279121 contains noted filters.	1000 h / 1 yr std. Air/Oil Separator MILLER: 206747** Ingersoll Rand: 89259337 						

260658-D

9-2. Routine Air Compressor Maintenance

<p>⚠ Stop engine before maintaining.</p> <p>👉 See Section 8-3 for engine/generator maintenance information.</p> <p>👉 Service air compressor more often if used in severe conditions.</p> <p>👉 Recycle air compressor fluids.</p>					
🕒	✓ = Check	◇ = Change	○ = Clean	☆ = Replace	Reference
Every 8 Hours	<p>○ Spills</p>	<p>✓ Oil Level</p>			Section 9-5
Every 250 Hours	<p>☆ Unreadable Labels</p>	<p>✓ Belt Tension</p>	<p>✓ Air Cleaner Hoses</p>	<p>✓ Air Filter Element</p>	Section 9-3
	<p>☆ Worn Or Damaged Air/Oil Hoses</p>	<p>○ Cooling System</p>			
Every 500 Hours	<p>◇ Oil</p>	<p>◇ Oil Filter</p>			Section 9-5
Every 1000 Hours	<p>◇ Air/Oil Separator</p>				Section 9-5

*To be done by factory authorized service agent.

9-3. Servicing Air Cleaner

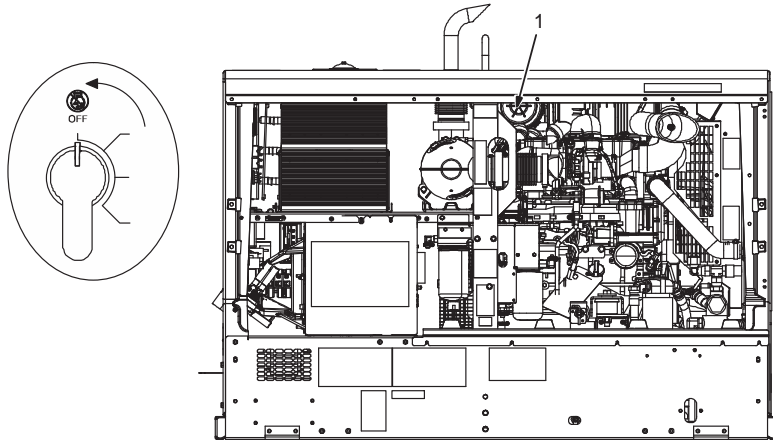

⚠ Stop engine.

NOTICE – Do not run engine without air cleaner or with dirty element. Compressor damage caused by using a damaged element is not covered by the warranty.

1 Compressor Air Cleaner

✎ The air cleaner primary element can be cleaned but the dirt holding capacity of the filter is reduced with each cleaning. The chance of dirt reaching the clean side of the filter while cleaning and the possibility of filter damage makes cleaning a risk. Consider the risk of unwarrantable equipment damage when determining whether to clean or replace the primary element.

NOTICE – If you decide to clean the primary element, we strongly recommend installing an optional safety element to provide additional engine protection. **Never clean a safety element.** Replace the safety element after servicing the primary element three times.

Service air cleaner element if red band appears in window. A green band means air cleaner is okay. Press button to reset indicator.

Clean or replace primary element if dirty (see note above before cleaning). Replace primary element if damaged. Replace primary element yearly or after six cleanings.

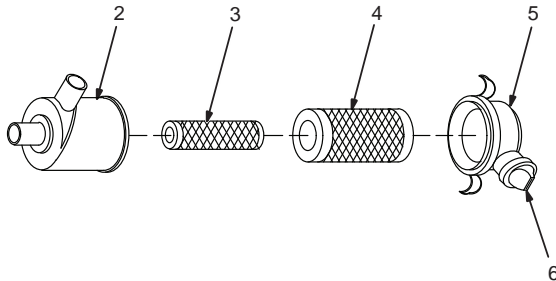

- 2 Housing
- 3 Safety Element (Optional)
- 4 Primary Element
- 5 Cover
- 6 Dust Ejector

To clean air filter

Wipe off cover and housing. Remove cover and dump out dust. Remove element (s). Wipe dust from inside cover and housing with damp cloth. Reinstall safety element (if present). Reinstall cover.

⚠ Do not clean housing with air hose.

Clean primary element with compressed air only.

Air pressure must not exceed 100 psi (690 kPa). Use 1/8 in (3 mm) nozzle and keep nozzle at least 2 in (51 mm) from inside of element. Replace primary element if it has holes or damaged gaskets.

Reinstall primary element and cover (dust ejector down).

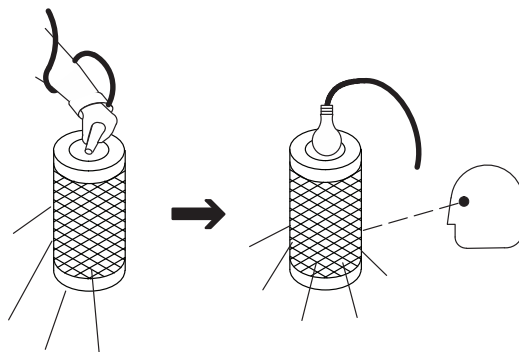

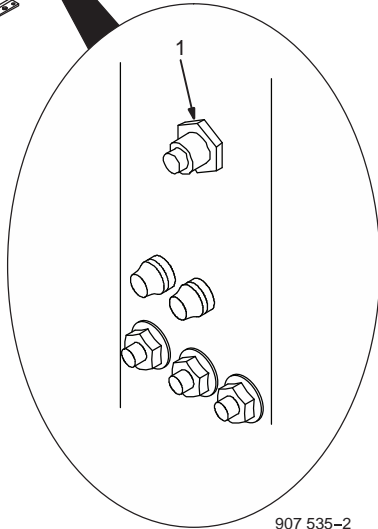
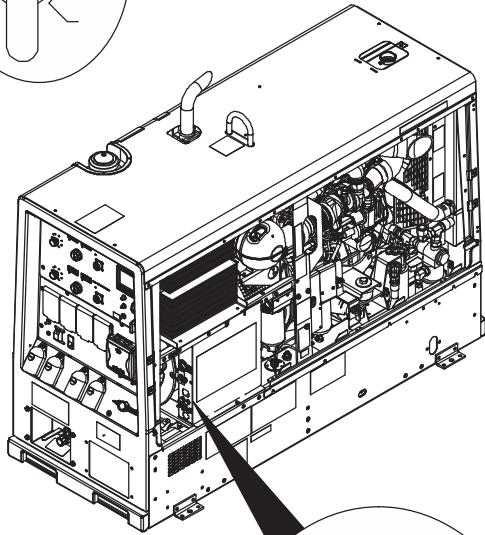
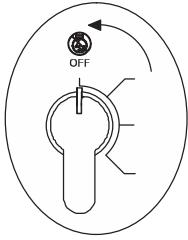

9-4. Compressor Overload Protection



907 535-2

 **Stop engine.**

 When a circuit breaker or fuse opens, it usually indicates a more serious problem exists. Contact Factory Authorized Service Agent.

 See Section 8-11 for engine/generator overload protection.

1 Circuit Breaker CB15

Circuit breaker CB15 protects the air compressor clutch. If CB15 opens, the compressor does not run and air output stops.

Press button to reset breaker.

9-5. Servicing Air Compressor

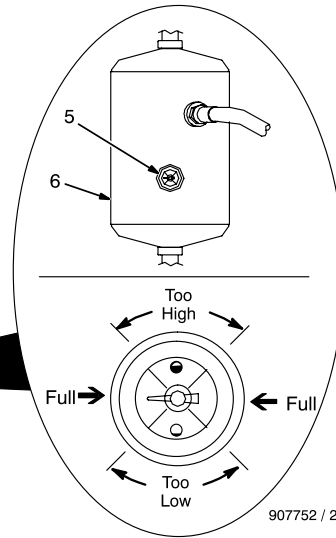
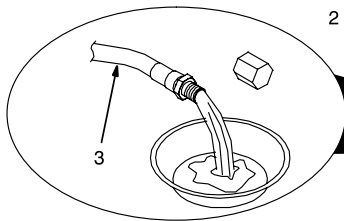
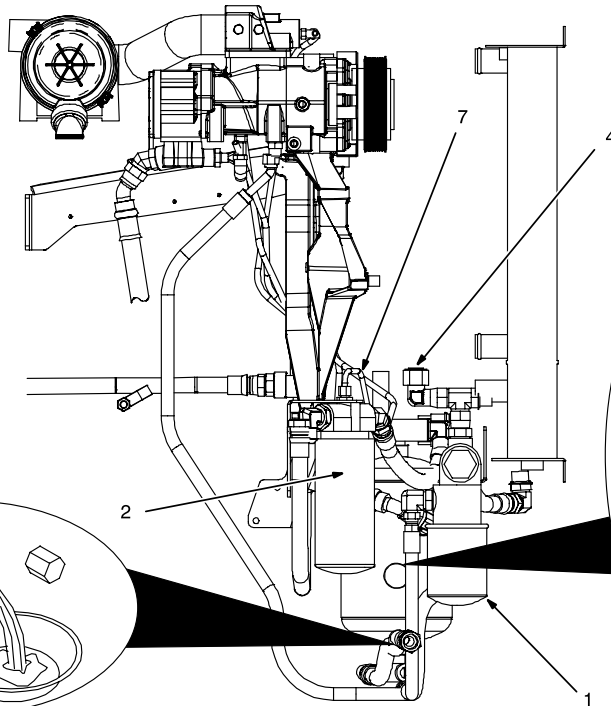
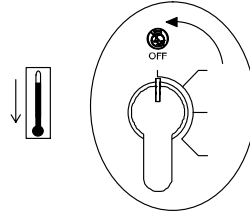
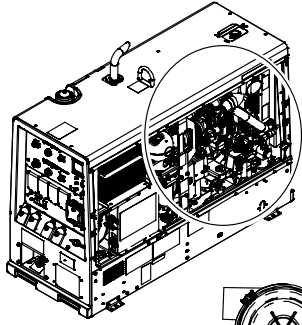
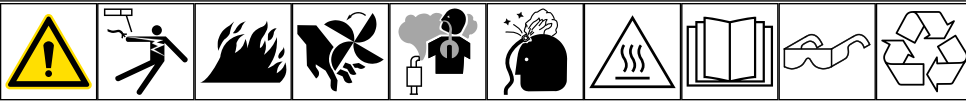

907752 / 255 862-A

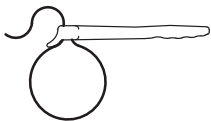

7/8, 15/16 in.

⚠ Stop engine and let cool. Wait 60 seconds for system pressure to drop before changing oil.

☞ Be sure o-rings at oil drain and oil fill fittings are in place before reinstalling caps.

- 1 Air Compressor Oil Filter
- 2 Secondary Air Compressor Air/Oil Separator
- 3 Air Compressor Oil Drain Hose w/Removable Cap
- 4 Air Compressor Oil Fill Cap
- 5 Air Compressor Oil Level Indicator
- 6 Air Compressor Primary Air/Oil Separator Tank
- 7 Oil Scavenge Tube

To change compressor oil and filter:

☞ The engine oil drain and compressor oil drain hoses are located together in the base. Be sure to select the correct hose when draining compressor oil.

Drain compressor oil while compressor is still warm.

Route compressor oil drain hose through hole in base. Remove compressor oil fill cap. Remove cap from oil drain hose and drain oil into a suitable container. Reinstall oil drain hose cap. Tighten cap with wrench.

Remove filter by turning filter counterclockwise. Remove filter. Apply thin coat of oil to gasket on new filter. Install new filter and turn clockwise until tight.

Add recommended oil until oil level indicator shows system is full (see compressor maintenance label for oil specifications). Reinstall oil fill cap. Tighten cap with wrench.

To replace secondary air/oil separator:

Loosen nut securing oil scavenge tube on separator base. Lift oil scavenge tube from separator. Turn filter counterclockwise. Remove filter.

Apply thin coat of oil to gasket on new filter. Install filter and turn clockwise. Reinstall oil scavenge tube.

Start engine, run air compressor, and check for oil leaks.

⚠ Stop engine.

9-6. Adjusting Compressor Air Pressure

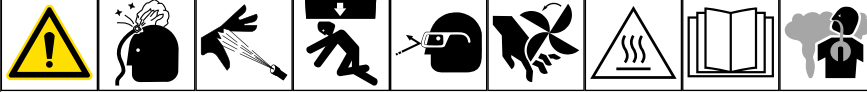

Air Compressor Assembly Left Side

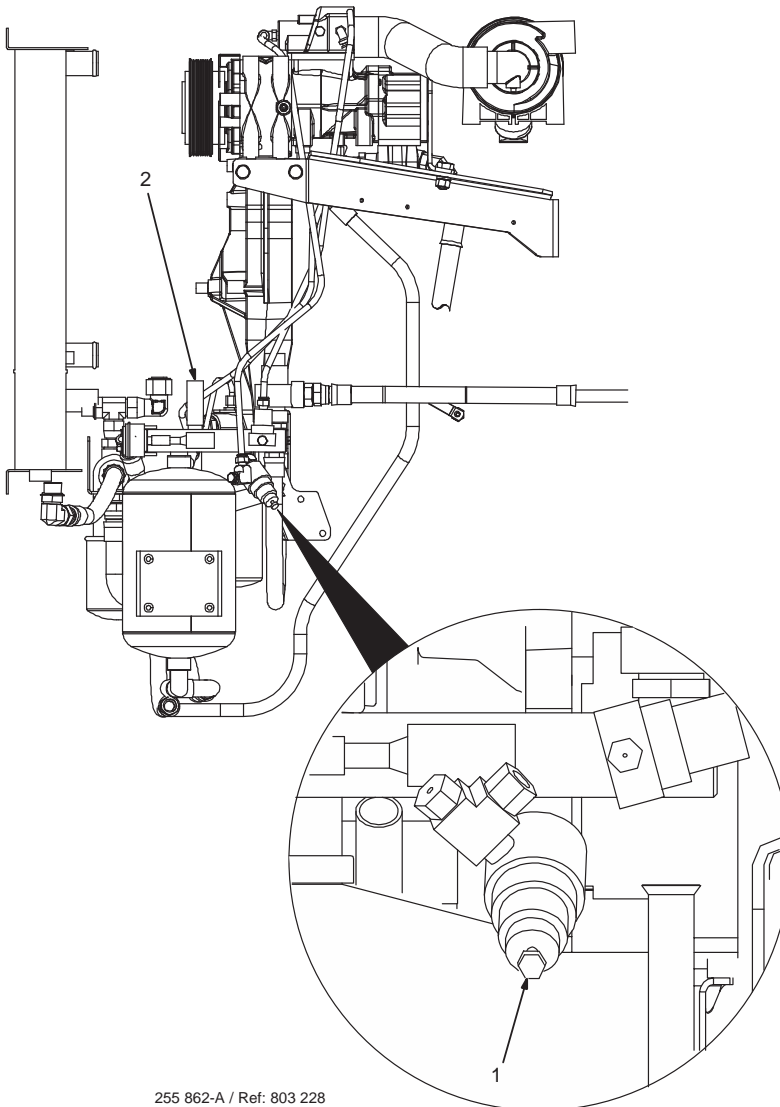
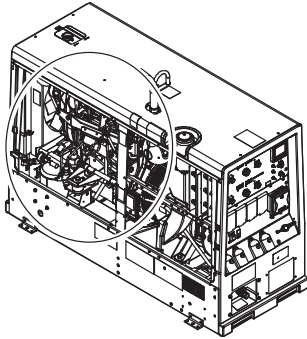

255 862-A / Ref: 803 228

Check compressor air pressure using air pressure gauge known to be accurate. If necessary, adjust air pressure as follows:

1 Screw

Loosen jam nut securing screw. Turn screw clockwise (increase pressure) or counter-clockwise (decrease) until pressure is 125 psi (862 kPa).

Maximum weld output is reduced if compressor air pressure is set above 125 psi (862 kPa).

Tighten nut.

2 Pressure Relief Valve

Pressure relief valve opens and releases pressure at 150 psi (1034 kPa). The pressure relief valve is not adjustable.

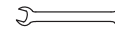
 5/16, 3/8 in.

SECTION 10 – TROUBLESHOOTING

10-1. Troubleshooting

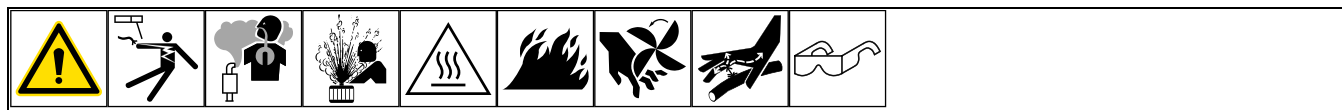

Also see Voltmeter/Ammeter error displays to assist in troubleshooting weld problems (see Section 8-12). Also see Engine Information Display to assist in troubleshooting engine related problems (see Section 13).

A. Welding

Trouble	Remedy
No weld output; generator power output okay at AC receptacles.	Place Process/Contactor switch in an Electrode Hot position, or place switch in a Remote On/Off Required position and connect remote contactor to Remote receptacle (see Section 6-10).
	Reset supplementary protector CB3 (see Section 8-11).
	Reset supplementary protector CB9 and/or CB29 (see Section 8-11). Check for faulty remote device connected to Remote receptacle.
	Check and secure connections to Remote receptacle (see Section 6-10).
	Check fuse F2, and replace if open (see Section 8-11). Have Factory Authorized Service Agent check brushes and slip rings, weld excitation circuit, and the rotor.
No weld output or generator power output at AC receptacles.	Disconnect equipment from generator power receptacles during start-up.
	Reset supplementary protector CB4 (see Section 8-11).
	Check fuses F1 and F2, and replace if open (see Section 8-11). Have Factory Authorized Service Agent check integrated rectifier SR2, capacitor C6, and the rotor.
	Have Factory Authorized Service Agent check brushes and slip rings, and field excitation circuit.
Erratic weld output.	Check and tighten connections inside and outside unit.
	Be sure connection to work piece is clean and tight.
	Use dry, properly stored electrodes.
	Remove excessive coils from weld cables.
	Have Factory Authorized Service Agent check brushes and slip rings.
High weld output.	Check position of Voltage/Amperage Adjust control.
	Have engine Factory Authorized Service Agent check engine speed.
	Have Factory Authorized Service Agent check voltage feedback circuit.
Low weld output.	Check position of Voltage/Amperage Adjust control.
	Have engine Factory Authorized Service Agent check engine speed.
	Check fuses F1 and F2, and replace if open (see Section 8-11). Have Factory Authorized Service Agent check integrated rectifier SR2, capacitor C6, and the rotor.
Low open-circuit voltage.	Have engine Factory Authorized Service Agent check engine speed.
	Check position of Process/Contactor switch.
No remote fine amperage or voltage control.	Check and secure connections to Remote receptacle (see Section 6-10).
	Repair or replace remote control device.
	Have Factory Authorized Service Agent check current sensing devices, and connections.
Constant speed wire feeder does not work.	Reset supplementary protector CB9 or CB29 (see Section 8-11).
	Check and secure connections to Remote receptacle (see Section 6-10).
	Repair or replace wire feeder.
Low CV weld output.	Increase Voltage/Amperage Adjust Control setting.
Min or max CV weld output only.	Check position of Voltage/Amperage Adjust control and Process/Contactor switch.
	Repair or replace remote control device.
	Have Factory Authorized Service Agent check Amperage/Voltage Adjust Control.
Arc terminates prematurely in GTAW Lift-Arc process.	Increase Auto-Stop (see Section 6-6).

B. Standard Generator Power

Trouble	Remedy
No generator power output at AC receptacles; weld output okay.	Reset receptacle supplementary protectors. Reset GFCI receptacle.
	Check fuse F1, and replace if open (see Section 8-11). Have Factory Authorized Service Agent check integrated rectifiers SR1 and SR2, resistor R3, and capacitor C6.
No generator power or weld output.	Disconnect equipment from generator power receptacles during start-up.
	Check fuses F1 and F2, and replace if open (see Section 8-11). Have Factory Authorized Service Agent check integrated rectifiers SR1 and SR2, capacitor C6, and the rotor.
	Reset supplementary protector CB4. Have Factory Authorized Service Agent check integrated rectifier SR1.
	Have Factory Authorized Service Agent check brushes and slip rings, and field excitation circuit.
High output at generator power AC receptacles.	Have engine Factory Authorized Service Agent check engine speed.
	Have Factory Authorized Service Agent adjust generator power field current resistor R3.
Low output at generator power AC receptacles.	Have engine Factory Authorized Service Agent check engine speed.
	Check fuse F1, and replace if open (see Section 8-11). Have Factory Authorized Service Agent check integrated rectifier SR2, resistor R3, and capacitor C6.
	Have Factory Authorized Service Agent check brushes and slip rings.

C. Three-Phase Generator Power

Trouble	Remedy
No or low output at three-phase generator/receptacle RC5.	Reset supplementary protector CB1 (see Section 7-1).
	Have engine Factory Authorized Service Agent check engine speed.
	Have Factory Authorized Service Agent check brushes and slip rings.
High output at three-phase generator/receptacle RC5.	Have engine Factory Authorized Service Agent check engine speed.
Erratic output at three-phase generator/receptacle RC5.	Have Factory Authorized Service Agent check brushes and slip rings.

D. Engine

Trouble	Remedy
Engine will not crank.	Supplementary protector CB2 open. Reset CB2.
	Check fuel level.
	Check battery connections and tighten if necessary. Check battery, and replace if necessary.
	Circuit breaker CB10 may be open. CB10 automatically resets when fault is corrected (see Section 8-11). Have Factory Authorized Service Agent check engine wiring harness and components.
	Air in fuel system. See engine manual.
	Check engine wiring harness plug connections.
	Have Factory Authorized Service Agent check control relay CR5 and Engine Control switch S1.
Engine cranks but does not start.	Check battery and replace if necessary. Check engine charging system according to engine manual.
	Have Factory Authorized Service Agent check control relay CR5. Have engine Factory Authorized Service Agent check fuel pump and fuel system.
Engine starts, but stops when Engine Control switch is released.	Check oil level. Automatic shutdown system stops engine if oil pressure is too low or engine temperature is too high (see Section 5-6). Automatic shutdown system is inhibited for 30 seconds after start-up.
	Have Factory Authorized Service Agent check control relay CR5.
Engine hard to start in cold weather.	Keep battery in good condition. Store battery in warm area off cold surface.
	Use fuel formulated for cold weather (diesel fuel can gel in cold weather). Contact local fuel supplier for fuel information.
	Use correct grade oil for cold weather (see maintenance label and engine manual).
Engine suddenly stops.	Check oil level. Automatic shutdown system stops engine if oil pressure is too low or engine temperature is too high (see Section 5-6). Automatic shutdown system is bypassed for 30 seconds after start-up.
	Check fuel gauge display. Check fuel level. Unit is equipped with low fuel level shutdown to prevent fuel tank from running dry.

Trouble	Remedy
	<p>Check engine display for diagnostic codes (see Section 13). If other codes appear, contact engine manufacturer's factory authorized service agent.</p> <p>Circuit breaker CB10 may be open. CB10 automatically resets when fault is corrected (see Section 8-11). Have Factory Authorized Service Agent check engine wiring harness and components.</p> <p>Reset supplementary protector CB2 (see Section 8-11). Have Factory Authorized Service Agent check engine alternator, engine harness, and the fuel pump.</p> <p>Have Factory Authorized Service Agent check control relay CR5.</p> <p>Check engine wiring harness and plug connections.</p> <p>See engine manual.</p>
Engine slowly stopped and cannot be restarted.	<p>Check fuel level.</p> <p>Check engine air and fuel filters (see Sections 8-7 and 8-10).</p> <p>See engine manual.</p>
Battery discharges between uses.	<p>Turn Engine Control switch off when unit is not running.</p> <p>Clean top of battery with baking soda and water solution; rinse with clear water.</p> <p>Recharge or replace battery if necessary.</p> <p>Periodically recharge battery (approximately every 3 months).</p>
Engine idles, but does not come up to weld speed.	<p>Have engine Factory Authorized Service Agent check speed control.</p>
Engine does not run at idle speed.	<p>Have engine manufacturer's authorized service agent check electronic speed control system.</p>
Engine uses oil during run-in period; wetstacking occurs.	<p>Dry engine according to run-in procedure (see Section 14).</p>

E. Air Compressor

Trouble	Remedy
Air compressor does not operate; no air pressure at air shutoff valve.	<p>Place Air Compressor switch in On position. The air compressor will not start if still under pressure. If compressor is turned off, wait for air pressure to bleed off (about 60 seconds) before turning compressor on again.</p> <p>Reset supplementary protector CB15 (see Section 9-4).</p> <p>Check compressor belt tension. Be sure correct belt is used and is properly installed.</p> <p>Verify secondary air/oil filter is not plugged. Replace air/oil separator.</p> <p>Have Factory Authorized Service Agent check Air Compressor switch S10, control relay CR10, air pressure switch S11, temperature switch S12, compressor control circuit, and air compressor clutch.</p>
Air compressor stops after short period of operation.	<p>Check compressor oil level (see Section 9-5). Automatic shutdown stops compressor if compressor temperature is too high.</p> <p>Clean debris from radiator. Automatic shutdown stops compressor if compressor temperature is too high.</p>
Low air pressure.	<p>Check for leaks in air lines and hoses.</p> <p>Adjust compressor air pressure (see Section 9-6).</p> <p>Check air compressor air cleaner (see Section 9-3).</p> <p>Have Factory Authorized Service Agent check compressor for rated output.</p>
High air pressure.	<p>Adjust compressor air pressure (see Section 9-6).</p> <p>Be sure control line is connected at regulator valve and inlet valve.</p>
Pneumatic tools freeze up because of moisture in compressed air.	<p>Install optional air dryer/filter kit (Part No. 195117).</p>
Oil in air from compressor.	<p>Check compressor oil level (see Section 9-5). If oil level is too high, system becomes saturated with oil.</p> <p>Change compressor air/oil separator (see Section 9-5).</p> <p>Check connections of control lines.</p> <p>Have Factory Authorized Service Agent check for blocked separator scavenge check valve/filter orifice.</p>
Oil in compressor air cleaner.	<p>Have Factory Authorized Service Agent verify compressor inlet valve is operating properly.</p>

SECTION 11 – PARTS LIST

11-1. Recommended Spare Parts

Item No.	Dia. Mkgs.	Part No.	Description	Quantity
		284184	USB Flash Drive	1
F1, F2		085874	Fuse, Mintr Cer Sloblo 10. Amp 250 Volt	2
		190823	Brush, Contact Elect .250 X.500 X 1.250 Grd Ay	3
		◆192939	Filter, Air Element Safety	1
		262459	Kit, Filters Deutz (2.9l4) Engine (Includes)	
		192938	—Filter, Air Element Primary	1
		255765	—Filter, Fuel Secondary	1
		255764	—Filter, Fuel Pri	1
		067265	—Oil Filter	1
			Battery, Stor 12v 925 Crk 195 Rsv Gp 31 Maint Free	1
		265120	Belt, V 1/2 X 5/16 X 52 (Big Blue 800 Duo Pro)	1
		279121	Filter Kit, Ingersoll Rand (Ce55 G1) (Air Pak Models) (Includes)	
		206745	—Filter, Oil	1
		197676	—Element, Air Cleaner	1
		206747	—Separator, Oil/Air Filter	1
		276620	—Oil, Air Compressor (Quart)	4
		253944	Belt, Microv 8 Rib (Air Pak Models)	1

◆Optional

SECTION 12 – ELECTRICAL DIAGRAMS

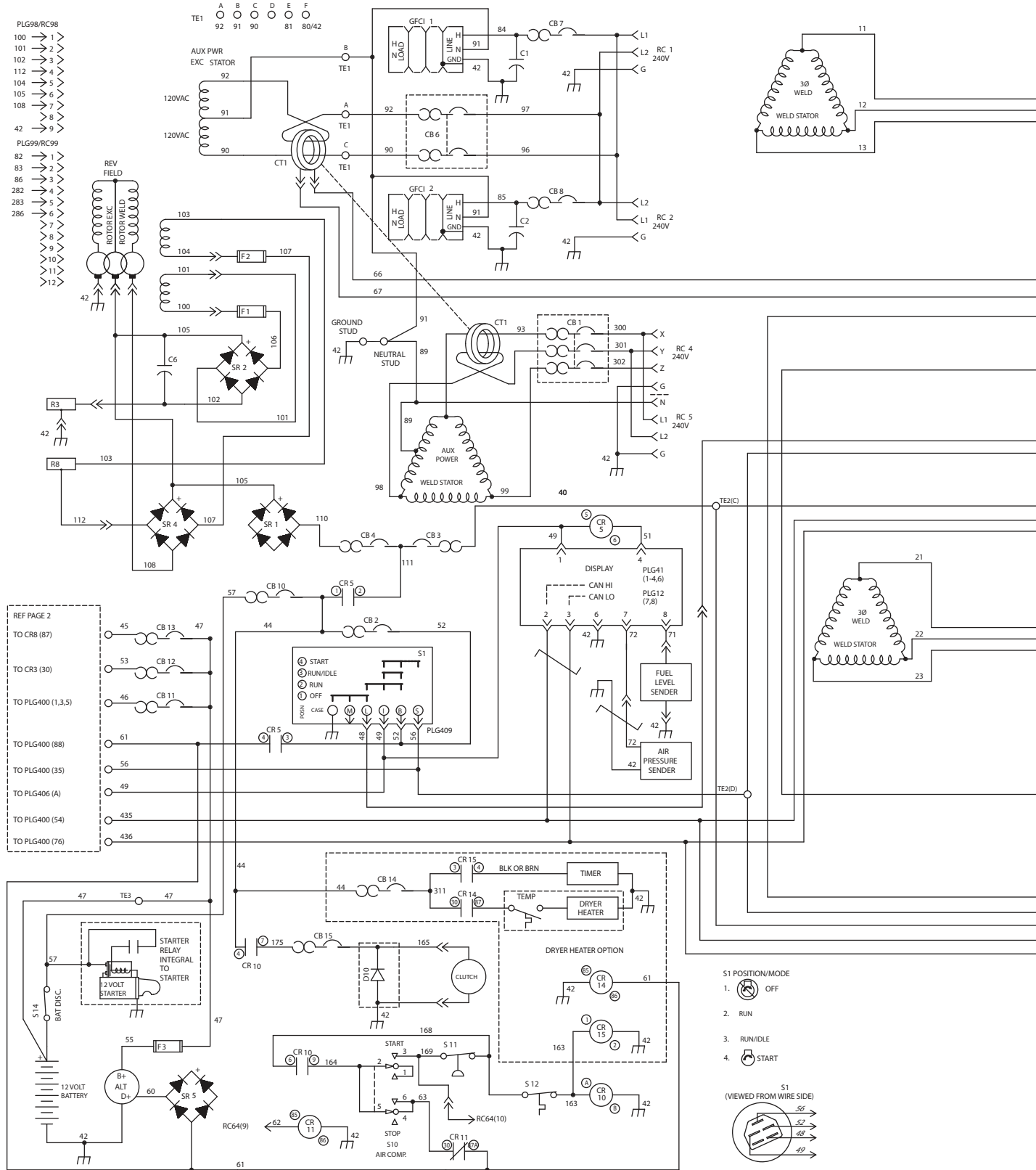
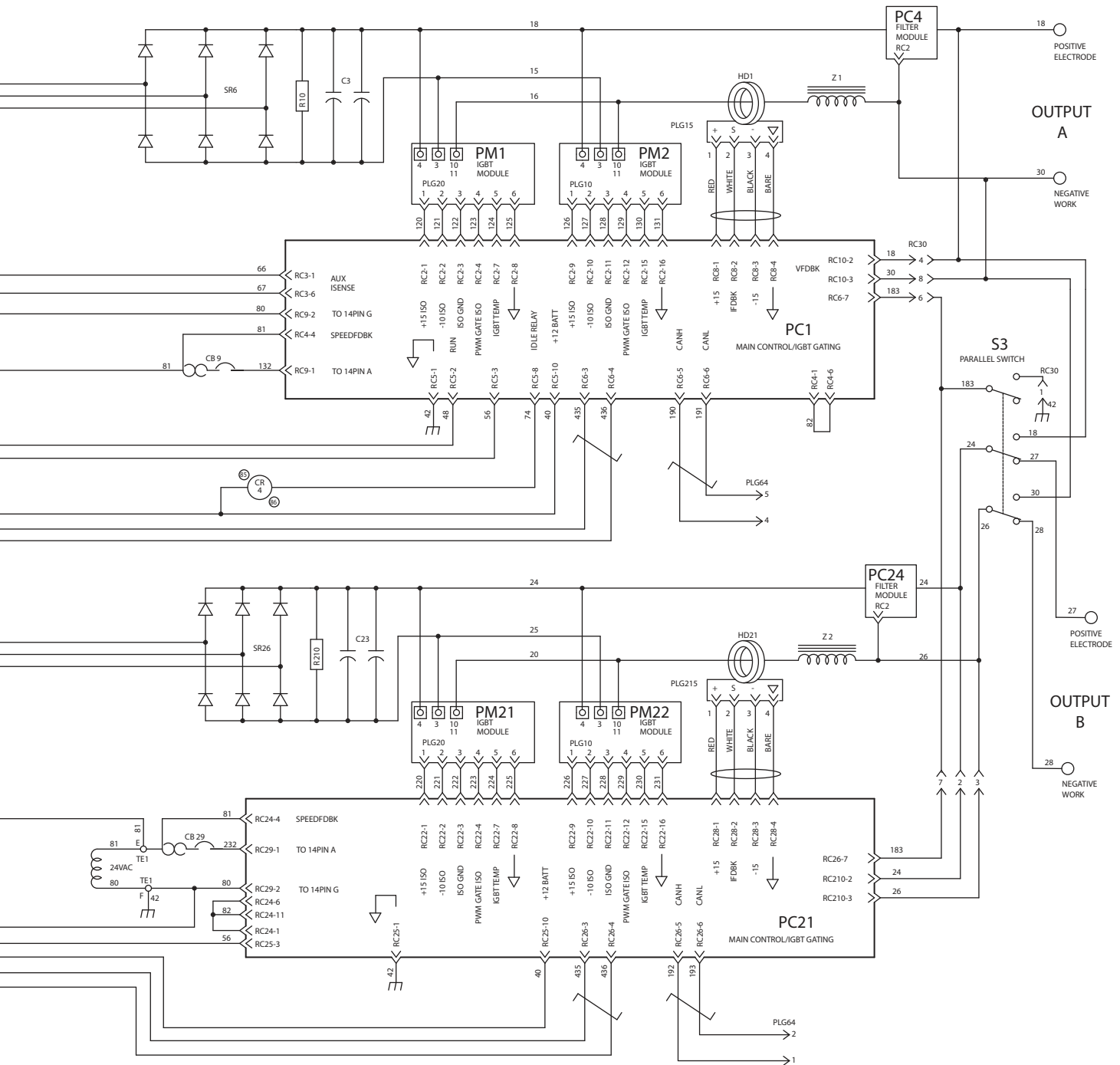



Figure 12-1. Circuit Diagram For Big Blue 800 Duo Air Pak Units — Page 1 of 2



 ELECTRIC SHOCK HAZARD	WARNING
	<ul style="list-style-type: none"> • Do not touch live electrical parts. • Disconnect input power or stop engine before servicing. • Do not operate with covers removed. • Have only qualified persons install, use, or service this unit.

288316-D

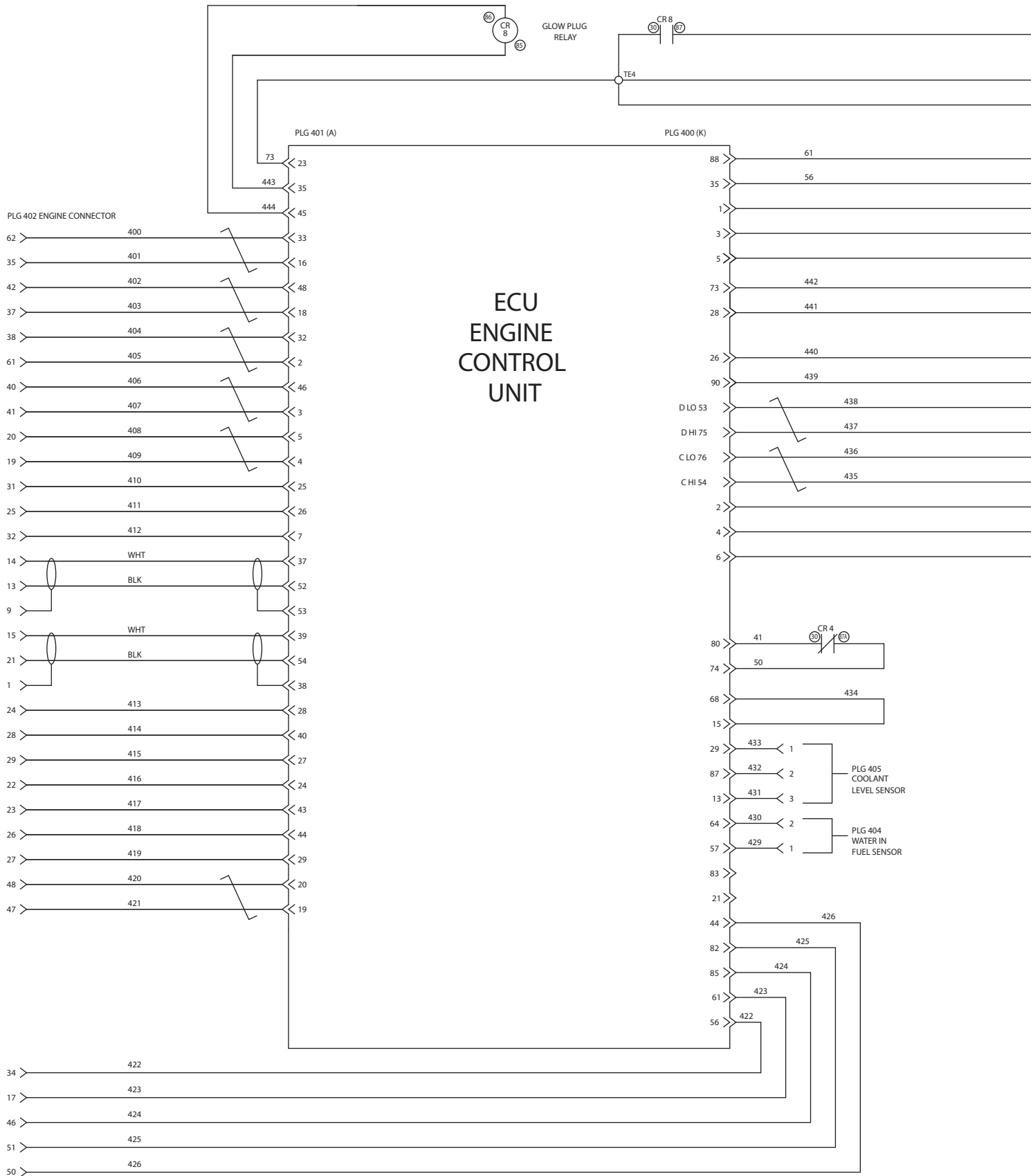
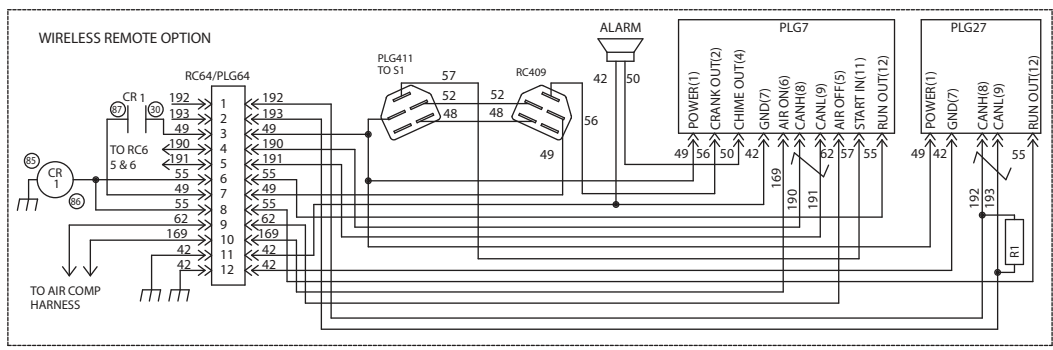
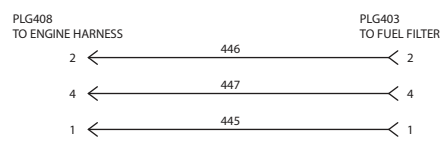
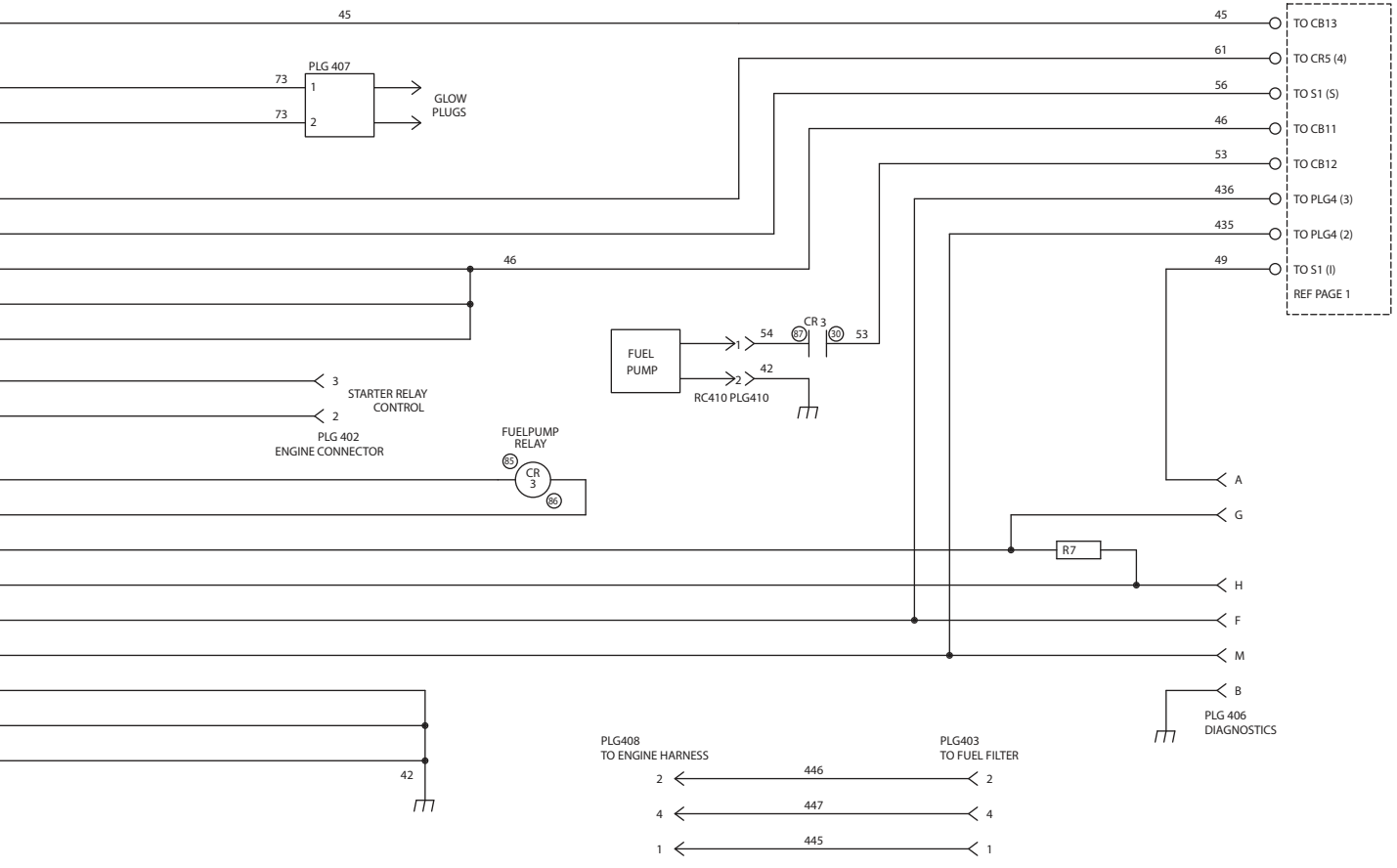

Figure 12-2. Circuit Diagram For Big Blue 800 Duo Air Pak — Page 2 Of 2



 ELECTRIC SHOCK HAZARD	WARNING
	<ul style="list-style-type: none"> • Do not touch live electrical parts. • Disconnect input power or stop engine before servicing. • Do not operate with covers removed. • Have only qualified persons install, use, or service this unit.

288316-D

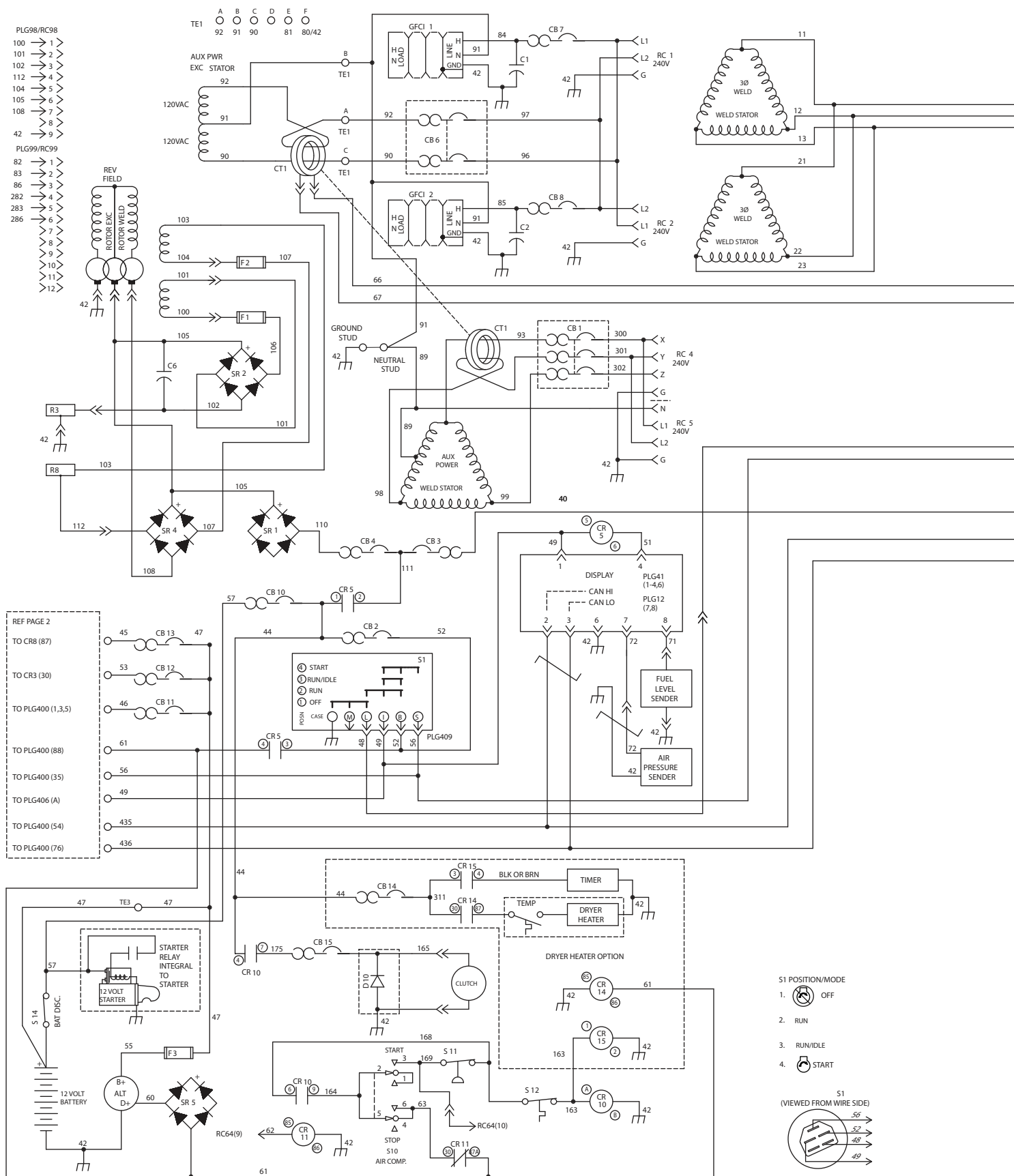
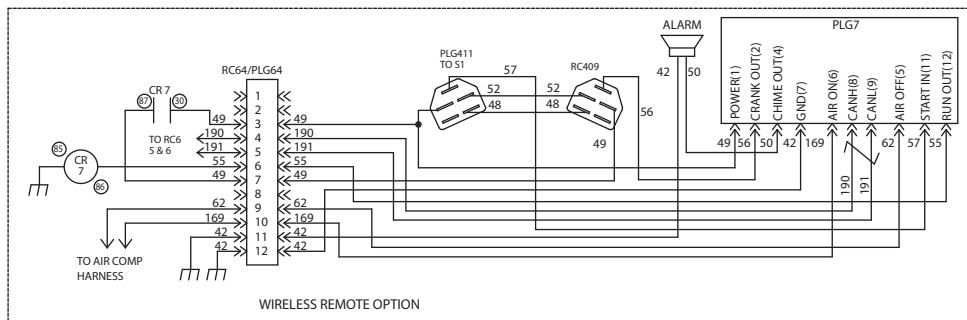
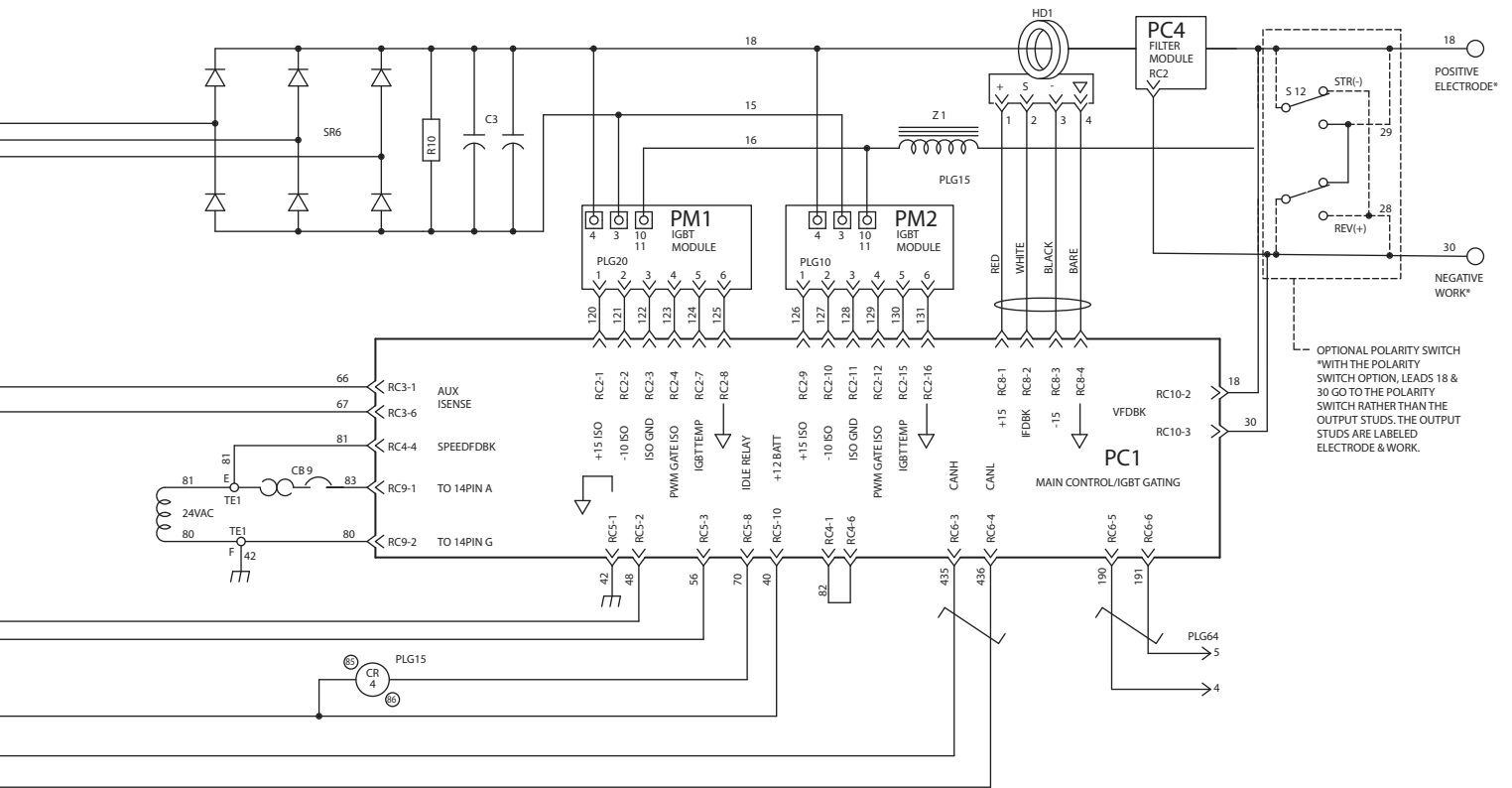

Figure 12-3. Circuit Diagram For Big Blue 600 Air Pak — Page 1 Of 2



	⚠ WARNING	<ul style="list-style-type: none"> Do not touch live electrical parts. Disconnect input power or stop engine before servicing. Do not operate with covers removed.
	ELECTRIC SHOCK HAZARD	<ul style="list-style-type: none"> Have only qualified persons install, use, or service this unit.

288315-D

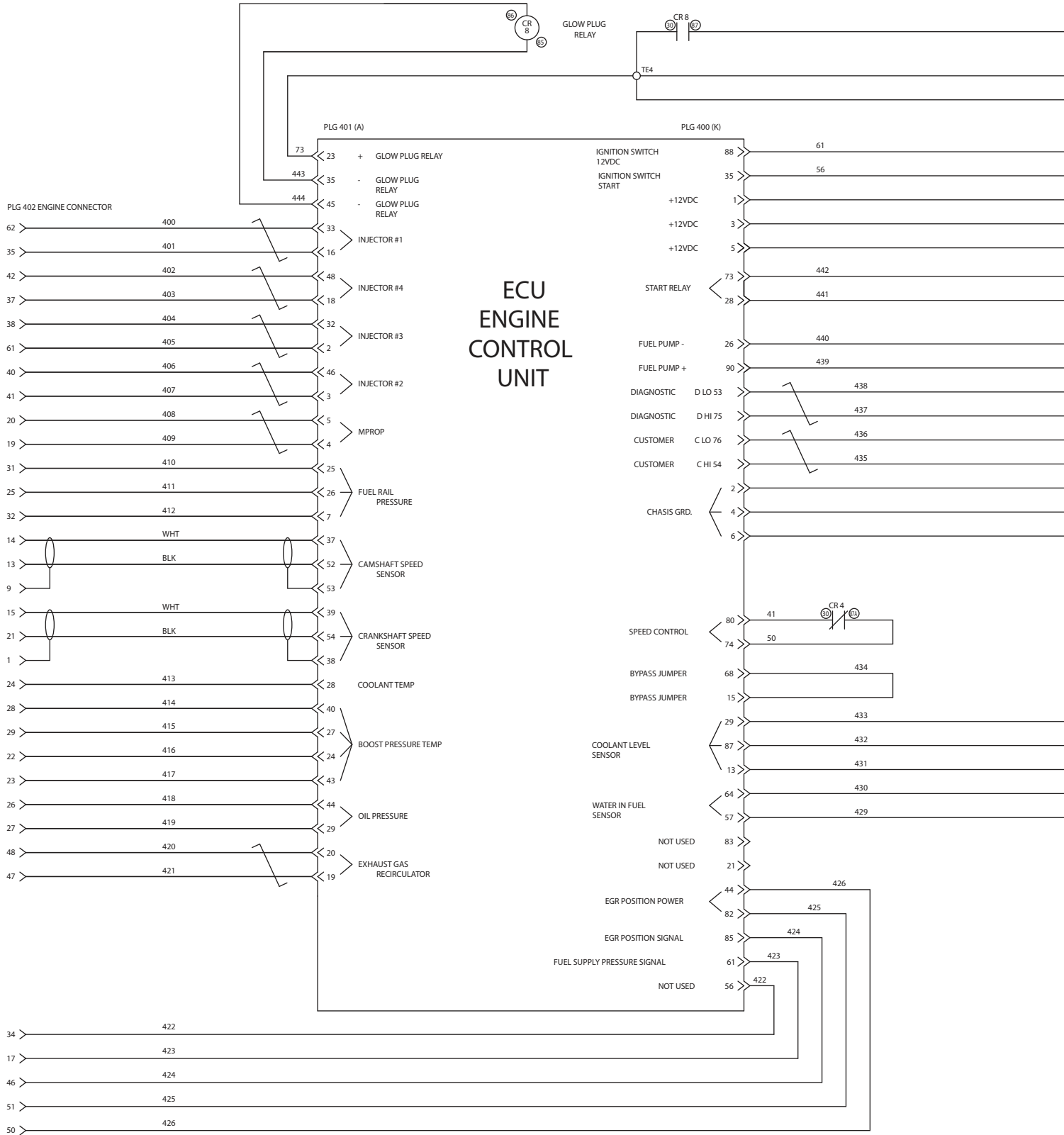
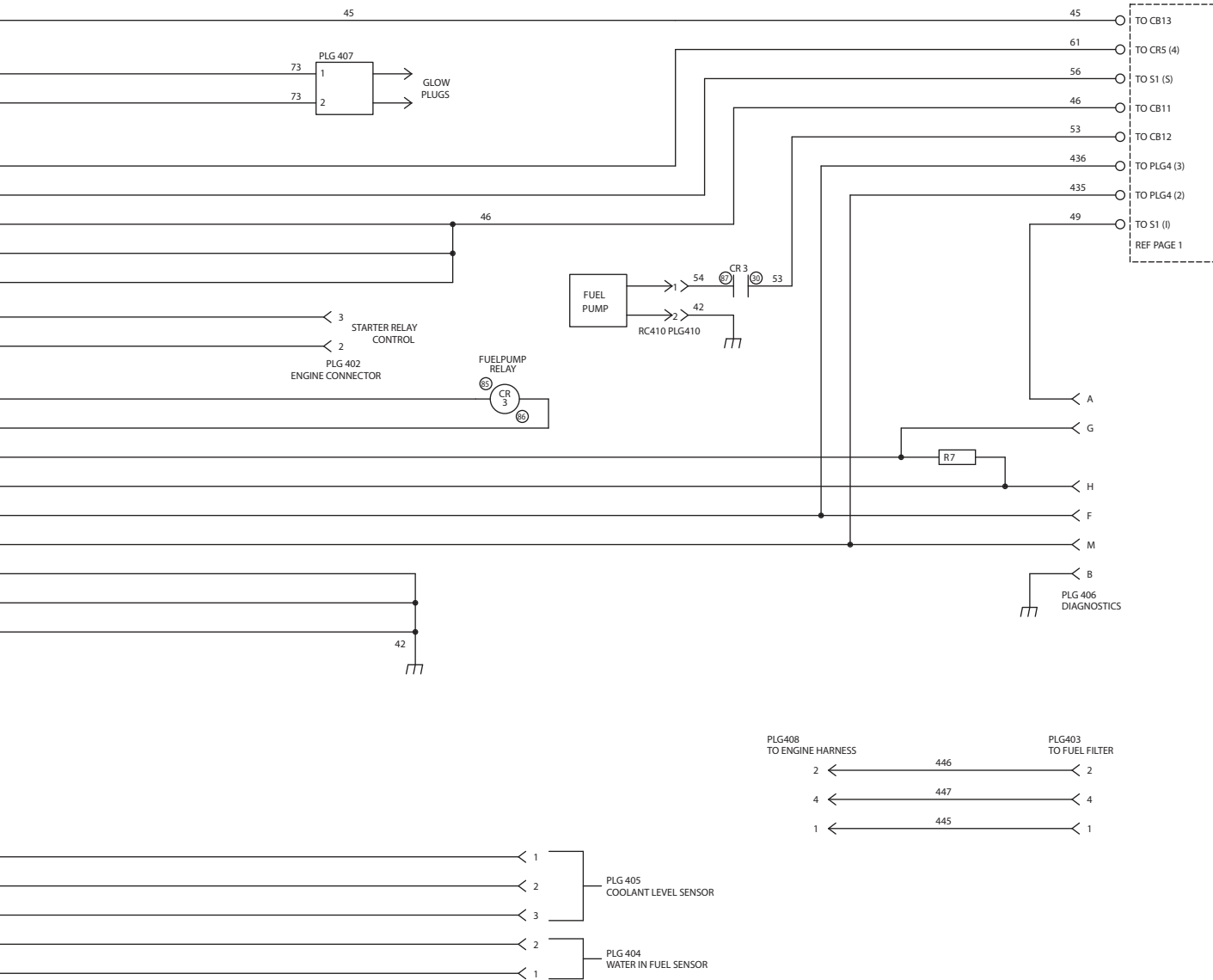

Figure 12-4. Circuit Diagram For Big Blue 600 Air Pak — Page 2 Of 2



	WARNING	<ul style="list-style-type: none"> Do not touch live electrical parts. Disconnect input power or stop engine before servicing. Do not operate with covers removed. Have only qualified persons install, use, or service this unit.
	ELECTRIC SHOCK HAZARD	

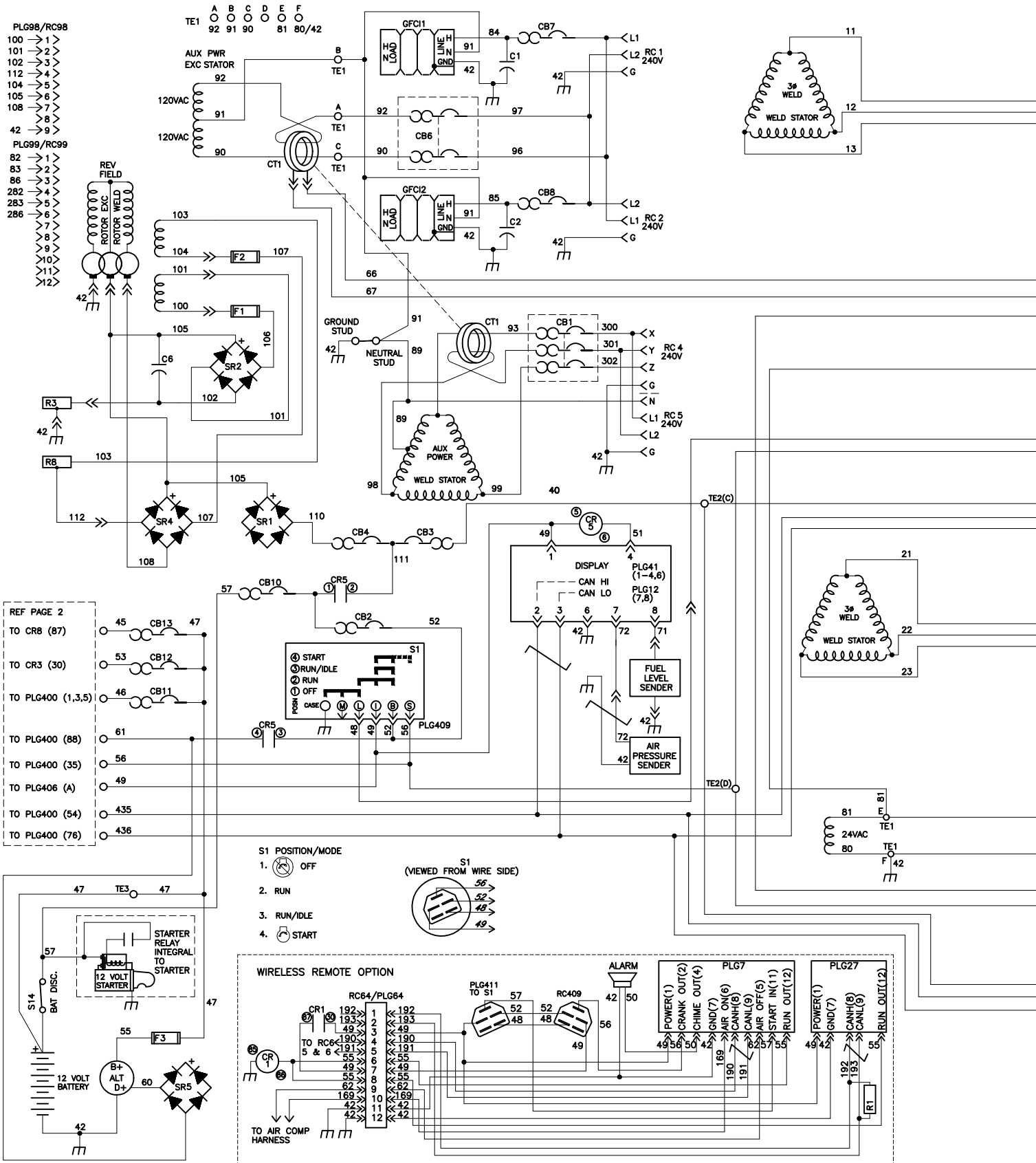
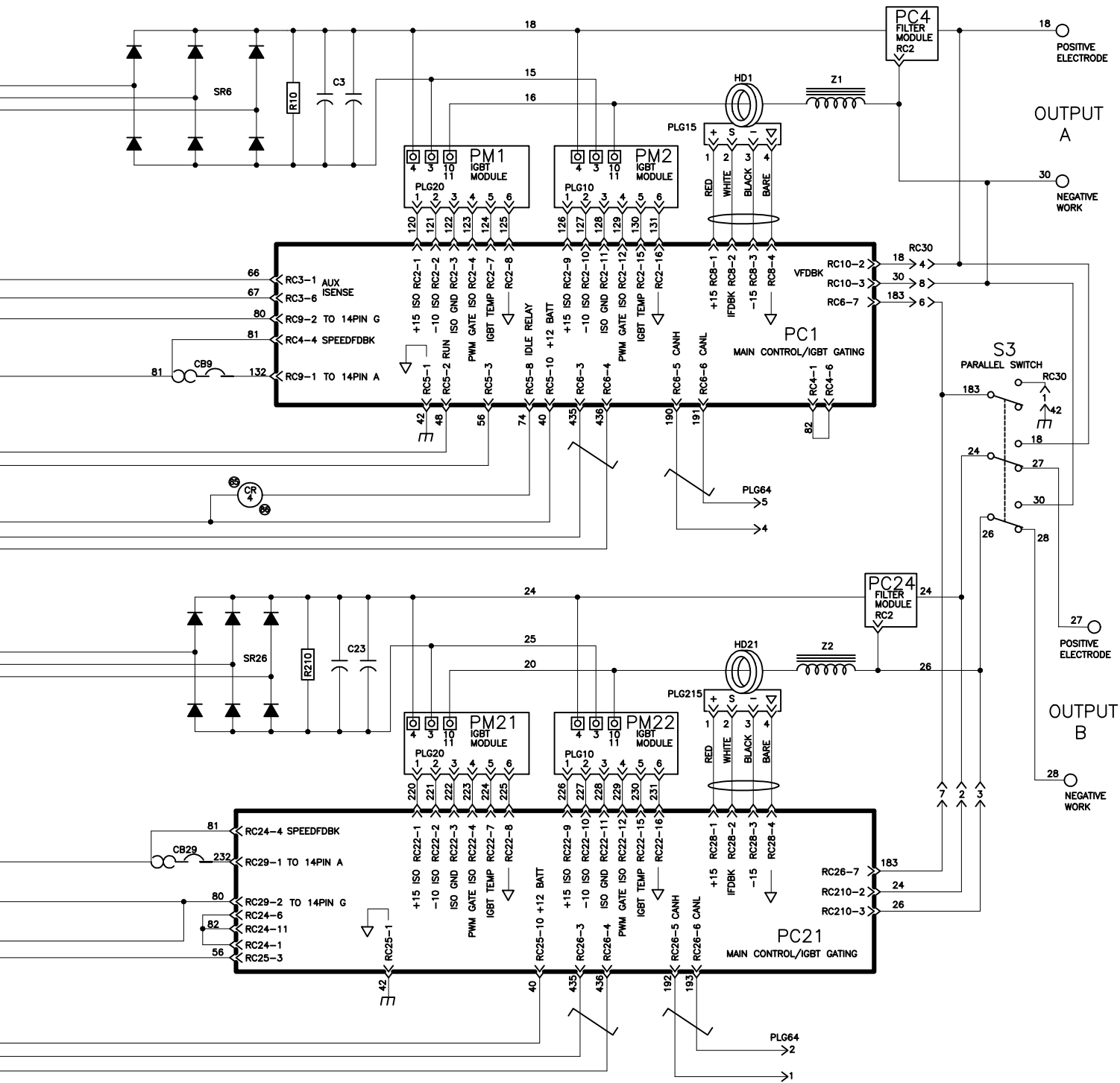



Figure 12-5. Circuit Diagram For Big Blue 800 Duo Pro — Page 1 Of 2



 ELECTRIC SHOCK HAZARD	WARNING <ul style="list-style-type: none"> • Do not touch live electrical parts. • Disconnect input power or stop engine before servicing. • Do not operate with covers removed. • Have only qualified persons install, use, or service this unit.
---	---

288317-C

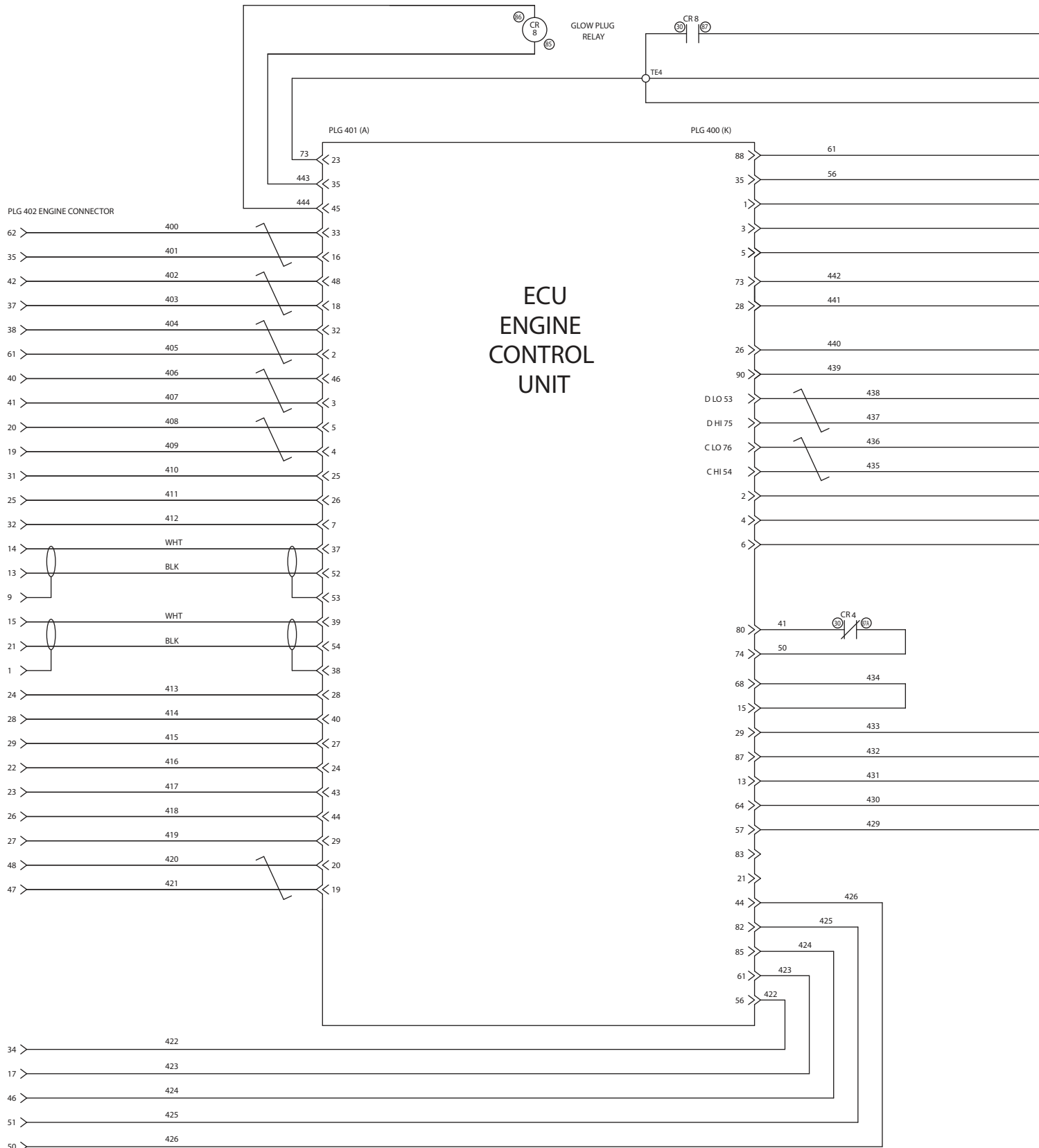

Figure 12-6. Circuit Diagram For Big Blue 800 Duo Pro — Page 2 Of 2

SECTION 13 – ENGINE INFORMATION DISPLAY

The views in this section are intended to be representative of all engine-driven welding generators. Your unit may differ from those shown.

13-1. Display Layout And Controls

MILLER ELECTRIC MFG. CO., APPLETON, WI USA

- 1 Engine Information Display
- 2 Engine Control Switch
- 3 Function Buttons
- 4 Yellow LED
- 5 Red LED

The Engine Information Display turns on whenever the Engine Control switch is in either Run or Run/Idle with the engine not running.

When starting the engine, pause Engine Control switch in Run or Run/Idle position for several seconds. The engine controller initiation sequence must occur. If glow plugs are on (automatically determined by ambient temperature), also wait until the initial Wait to Start message on the display is cleared (see Section 13-4).

Function buttons are used to navigate through menus, increase/decrease, and select (see Section 13-2).

The yellow LED lights as part of sequences used to alert the operator to errors or conditions that will affect operation, such as low fuel.

The red LED lights as part of a shutdown sequence, such as when fuel is too low or oil pressure is too low to continue operation without damaging the engine.

There are two display types: 6-Up and 1-Up. The default 6-Up display shows six values at once. The 1-Up display shows one value on the screen. See Sections 13-5 and 13-6.

13-2. Function Buttons

PREV

NEXT

MENU

VIEW

ENTER

CANCEL

DIAG

	Function Button				
	Previous	Next	Menu/Cancel	View	Enter/Diagnostic
6-Up Display	None	None	Menu	Go to 1-Up	Engine Diagnostics
1-Up Display	Previous	Next	Menu	Go to 6-Up	Engine Diagnostics

13-3. RPM Signal Failed Display



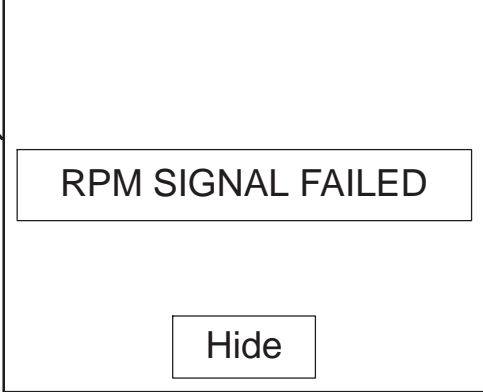

1

1 RPM Signal Failed Display

If the operator places the Engine Control switch in the Run/Idle or Run position and does not start the engine, a timer starts. If this condition exists for 30 minutes or longer, the RPM signal failed message appears. Place Engine Control switch in Off position to reset.

13-4. Service Reminder Screen



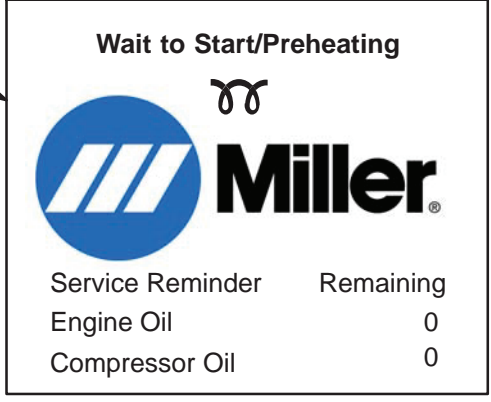

1

Service Reminder	Remaining
Engine Oil	0
Compressor Oil	0



2

Service Reminder	Remaining
Engine Oil	480
Compressor Oil	495

Glow plugs turn on automatically as determined by ambient temperature. Compressor oil information appears only on models with air compressor.

1 Wait to Start/Preheating Display

The Wait to Start display appears when the Engine Control switch is in the Run or Run/Idle position and glow plugs are functioning. The operator needs to pause at either switch

2 Service Reminder Display

The Service Reminder display shows servicing intervals in hours counting down from engine manufacturer recommended service intervals. This display appears for a few

seconds. It can also be found as a 1-Up screen (see Section 13-7).

The 6-Up Display then appears as the default. The engine can be started when the 6-Up Display appears.

If the Enter/Diagnostic function button is pressed while in this display, the DM2 diagnostic screen appears. (see Section 13-11).

13-7. 1-Up Displays





0_H

Machine Hours



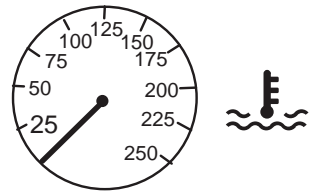

0_F

Coolant Temperature



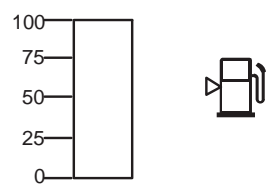

0 %

Fuel Level



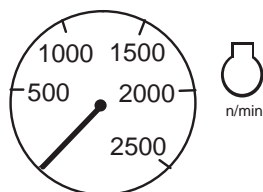

0_{RPM}

Engine Speed



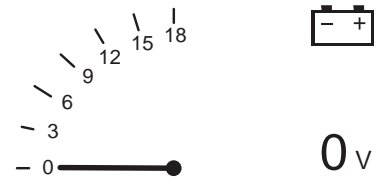

0_V

Battery Potential



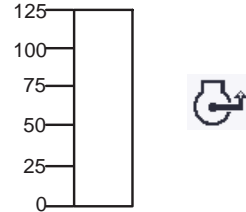

0 %

Percent Load@RPM



Engine Oil

0_H

Service Reminders



To go to the next display, press the Next function button. To return to previous

display, press the Previous function button.

To return to the 6-Up Display, press the View function button.

13-8. 1-Up Compressor Displays

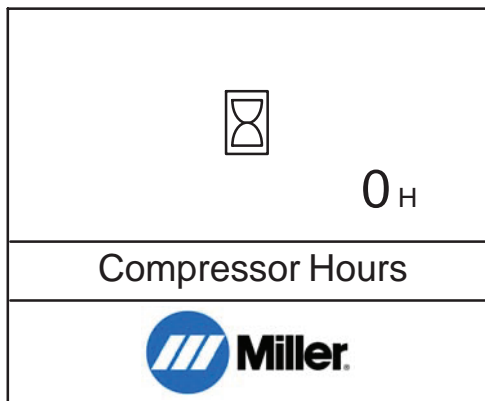
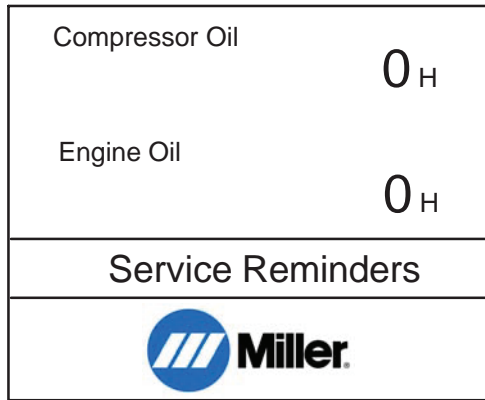
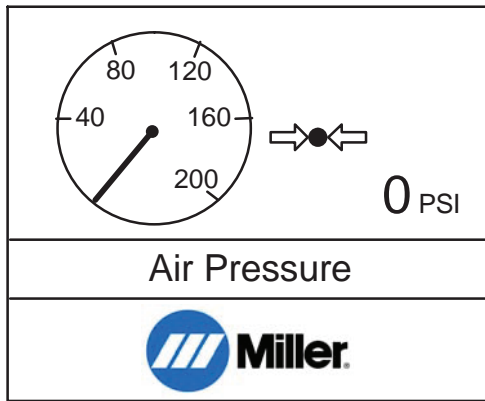

To go to the next display, press the Next function button. To return to previous display, press the Previous function button. To return to the 6-Up Display, press the View function button.

Air Pressure display does not appear if the air pressure input is less than 50 PSI.

13-9. Fuel Level Warnings

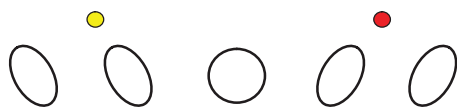
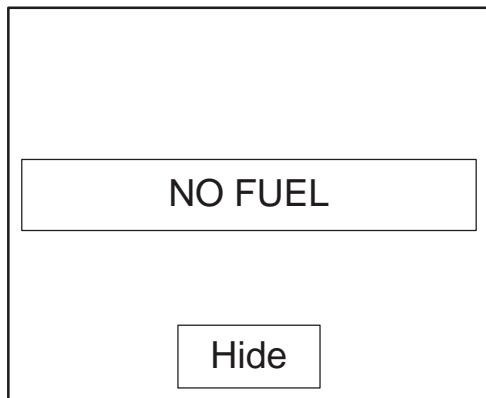
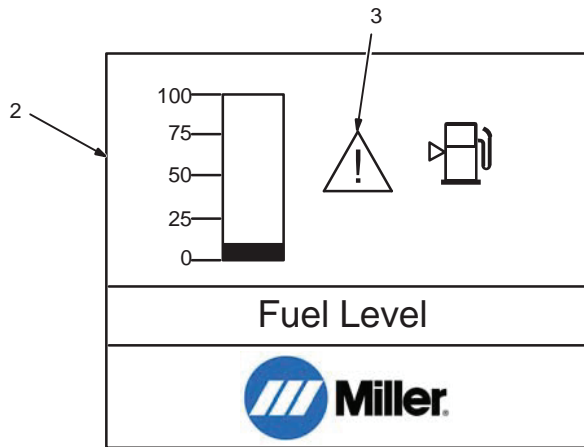
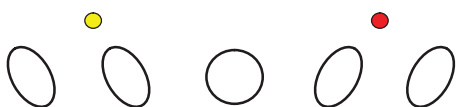
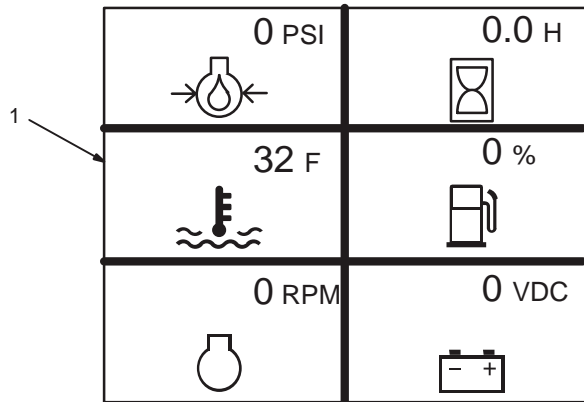
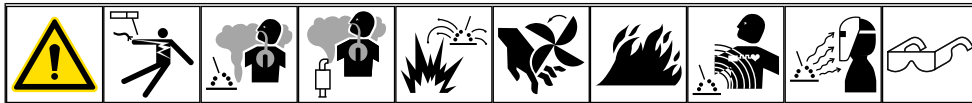

Fuel level warnings are generated by sensors at the fuel tank. All engine warnings that are displayed are generated by the engine controller (see Sections 13-10 and 13-11).

- 1 6-Up Display
- 2 1-Up Fuel Level Display
- 3 Low Fuel Warning

The low fuel warning indicator appears and begins to flash when fuel level reaches 10%. It continues to flash until fuel level falls to 0%.

- 4 Yellow LED

The yellow LED begins to flash when the low fuel warning appears. It continues to flash until 0% is reached.

- 5 Red LED

The red LED turns on and stays lit when fuel level reaches 0%. The engine will shut down.

- 6 No Fuel Display

This display appears at engine shutdown. Turn Engine Control switch to Off, refuel, and restart.

13-10. Warning Or Shutdown Display

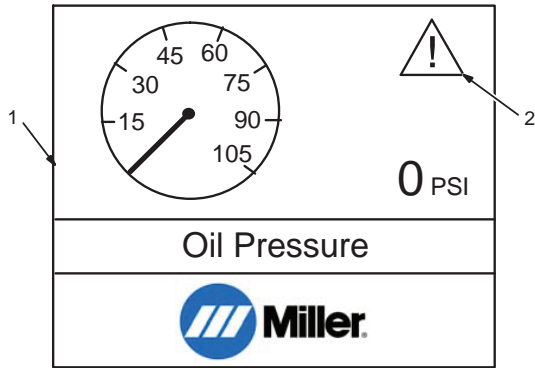

- 1 Oil Pressure Display
- 2 Fault Warning Indicator

The warning symbol appears on the display when an engine condition approaches a shutdown condition.

- 3 Fault Shutdown Indicator

The shutdown symbol appears on the display when a severe engine fault can cause shutdown.

The 6-up or 1-up screen with fault indicator is shown briefly and automatically advances to the fault display.

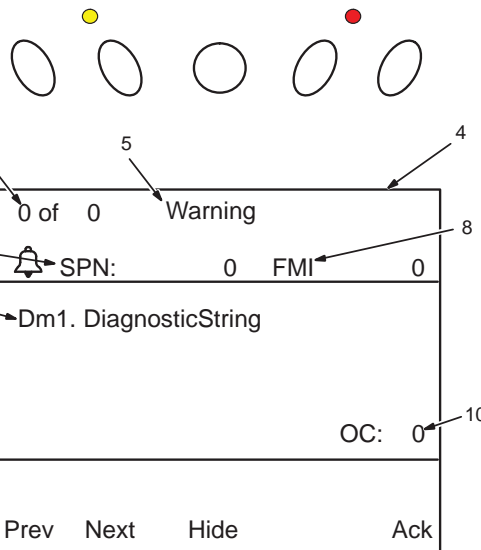

- 4 Fault Display
- 5 Level Of Fault
- 6 Indicates Number Of Faults
- 7 Suspect Parameter Number
- 8 Failure Mode Identifier

The SPN and FMI numbers are generated by the engine controller according to the J1939 standard. Typical faults are listed in Table 13-1.

- 9 Diagnostic Description
- 10 Occurrence Count

For non-critical faults, the number of occurrences can accumulate.

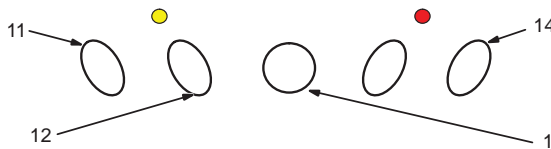

- 11 Previous Function Button
- 12 Next Function Button
- 13 Hide Function Button

Non-critical faults can be hidden.

- 14 Acknowledge Function Button (Ack)

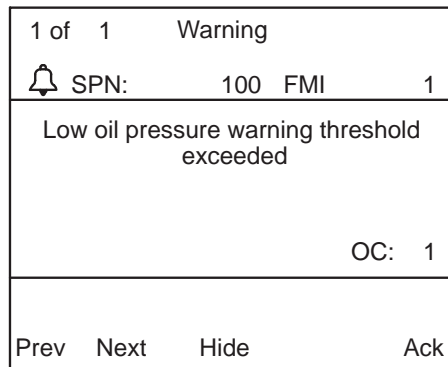

To acknowledge the fault and advance the display to the 1-up or 6-up display, press the Ack function button and then the Hide function button.

The condition that caused the warning or shutdown must be remedied before operation can continue.

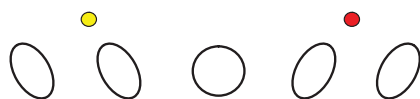

Table 13–1. Fault Descriptions

This is an abbreviated list of faults. These faults can commonly be remedied by the operator. If other faults appear, contact Factory Authorized Service Agent.

SPN	FMI	Description of Fault
Tier 3 or Tier 4 Interim Engines		
100	2	Low oil pressure; warning threshold exceeded
110	2	High coolant temperature; warning threshold exceeded
Tier 4 Final Engines		
94	1	Low fuel pressure; warning threshold exceeded
100	1	Low oil pressure; warning threshold exceeded
110	0	High coolant temperature; warning threshold exceeded
111	1	Coolant level too low
168	2	High battery voltage; warning threshold exceeded
174	0	High low fuel temperature; warning threshold exceeded
175	0	High oil temperature; warning threshold exceeded
97	0	Water in Fuel is Detected

13-11. Engine Diagnostic Display



Engine diagnostic codes are for use by the engine Factory Authorized Service Agent only. Attempting engine repair may void engine warranty.

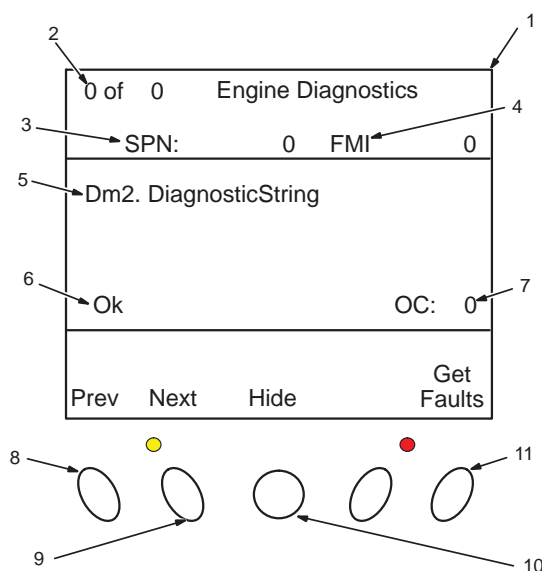

- 1 Diagnostic Display
- 2 Number Of Faults
- 3 Suspect Parameter Number
- 4 Failure Mode Identifier

The SPN and FMI numbers are generated by the engine controller according to the J1939 standard.

- 5 Diagnostic Description
- 6 Requesting/Ok

Requesting appears on the display as the display communicates with the engine controller. Once all diagnostic codes are available, Ok appears on the display.

- 7 Occurrence Count

For non-critical faults, the number of occurrences of each fault can accumulate.

- 8 Previous Function Button
- 9 Next Function Button
- 10 Hide Function Button

Non-critical faults can be hidden.

- 11 Get Faults Function Button

13-12. Main Menu Access Code

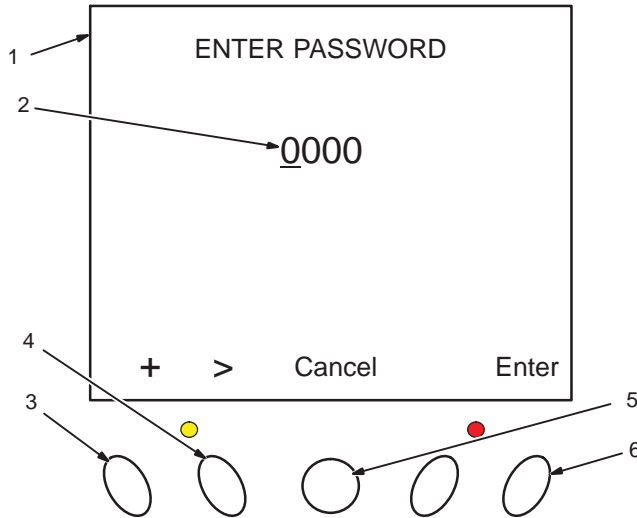
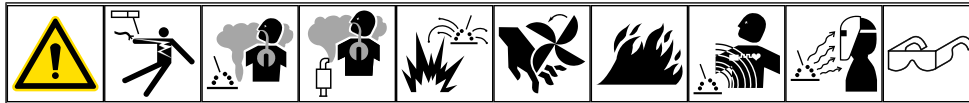

1 Access Code Display

An access code is required to gain access to the main menu. This display appears whenever the Menu/Cancel function button is pressed while in the 1-Up or 6-Up display

2 Access Code (Password)

The factory set access code is 1000. This access code is not programmable and cannot be changed.

3 Increase Number Function Button

4 Go to Next Number Function Button

Use the increase function button to increase the value underlined. Use the > function button to move to the next digit.

5 Cancel Function Button

6 Enter Function Button

13-13. Main Menu Options: Resetting Hours At Oil Change

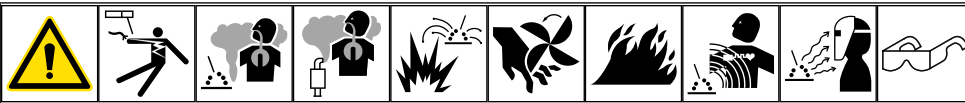

1

Brightness	0%
Contrast	0
Units	English
Reminders	▶
OEM	
Version	
Stored Codes	
Language	English

2

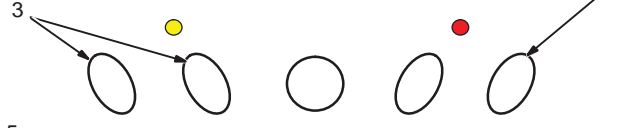

5

Service Reminder	Interval	Remaining
Engine Oil	▶ 500	0
Compressor Oil	500	490

Change Engine Oil		
Modify	Reset	Cancel

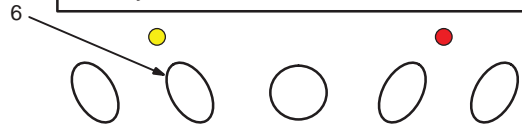

- 1 Main Menu
 - 2 Cursor
 - 3 Scroll Function Buttons
- Use scroll function buttons to move cursor.
- 4 Select Function Button
- When the cursor is in desired position, press Select function button to go to sub-menu.
- 5 Service Reminders Display
- Move cursor to select engine or compressor and press Select function button. The appropriate Change Oil display appears.
- 6 Reset Function Button
- Press the Reset function button to reset Remaining Hours after changing oil.

13-14. Main Menu Options: Brightness, Contrast, And Units

1 Main Menu

2 Cursor

3 Scroll Function Buttons

4 Select Function Button

5 Brightness Menu Display

6 Contrast Menu Display

7 Units Menu Display

Use scroll function buttons to move cursor.

When the cursor is in desired position, press Select function button to go to sub-menu.

Use scroll function buttons to increase or decrease display brightness. When desired percentage is reached, press Select function button.

Use scroll function buttons to increase or decrease display contrast (lightness/darkness). Contrast range is 0 to 175. Viewing angle affects appearance of display. When desired contrast is reached, press Select function button.

Use scroll function buttons to scroll through choices:

- English (PSI, °F)
- Bar (Bar, °C)
- Kpa (Kpa, °C)

When desired units configuration is reached, press Select function button.

13-15. Main Menu Options: Reminders

Brightness	0%
Contrast	0
Units	English
Reminders	
OEM	
Version	
Stored Codes	
Language	English

Service Reminder	Interval	Remaining
Engine Oil	500	0
Compressor Oil	500	490

Change Engine Oil

Modify Reset Cancel

Change Engine Oil

000000H

+ > Cancel Enter

1 Main Menu

2 Cursor

3 Scroll Function Buttons

Use scroll function buttons to move cursor.

4 Select Function Button

When the cursor is in desired position, press Select function button to go to sub-menu.

5 Service Reminders Display

Move cursor to select engine or compressor and press Select function button. The appropriate Change Oil display appears.

6 Reset Function Button

Press the Reset function button to reset Remaining Hours after changing oil.

7 Modify Function Button

NOTICE – The service interval can be modified. Shorter service intervals may be appropriate during heavy use or in certain environments (such as dusty or extreme temperatures). Lengthening service intervals is not recommended and could result in voiding engine warranty.

8 Increase Number Function Button

9 Go To Next Number Function Button

Use the increase function button to increase the value underlined. Use the > function button to move to the next digit.

10 Cancel Function Button

11 Enter Function Button

13-16. Main Menu Options: OEM, Version, Stored Codes, And Language

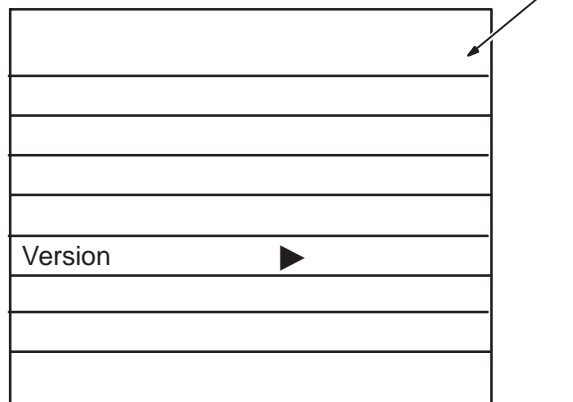
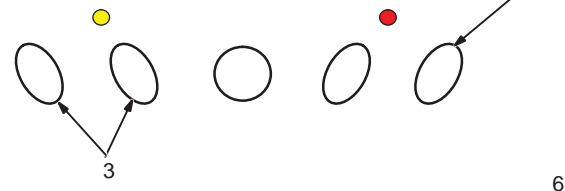
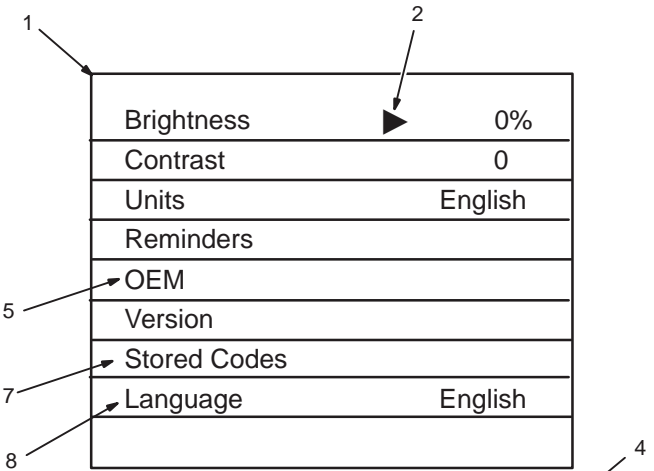

Configuration	0.0.0.0
Bootloader	00.00. 00.00
Firmware	00.00. 00.00
Part Number	XX-XX-XXXX

- 1 Main Menu
- 2 Cursor
- 3 Scroll Function Buttons
- Use scroll function buttons to move cursor.
- 4 Select Function Button
- When the cursor is in desired position, press Select function button to go to sub-menu.
- 5 OEM Menu Option
- This menu option is for Factory Authorized Service Agents only and is password protected.
- 6 Version Menu Display
- The information in this display may be requested by a Factory Authorized Service Agent during troubleshooting.
- 7 Stored Codes
- Stored codes can also be accessed when the initial Service Reminder display appears as the engine controller is initiating (see Sections 13-4 and 13-11).
- 8 Language Menu Display
- Use scroll function buttons to scroll through choices: English, French, Italian, Spanish, and Brazilian Portuguese. When desired language is reached, press Select function button.

SECTION 14 – RUN-IN PROCEDURE

NOTICE – Diesel engines in Miller equipment are meant to operate optimally at moderate to rated load. Using light or no load for extended periods of time may cause wetstacking or other engine damage. Do not idle engine longer than necessary.

14-1. Wetstacking

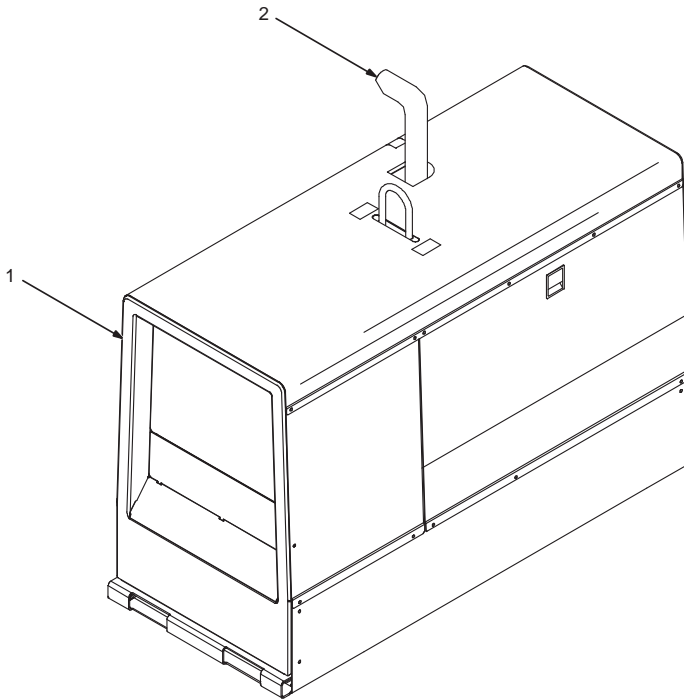

NOTICE – Do not perform run-in procedure at less than 20 volts weld output and do not exceed duty cycle or equipment damage may occur.

1 Welder/Generator

Run diesel engines near rated voltage and current during run-in period to properly seat piston rings and prevent wetstacking. See nameplate, rating label, or specifications section in this manual to find rated voltage and current.

NOTICE – Do not idle engine longer than necessary. Piston rings only seat correctly if engine runs at weld/power rpm, and the welder/generator is kept loaded during run-in.

2 Engine Exhaust Pipe

Wetstacking is unburned fuel and oil in the exhaust pipe and occurs during run-in if the engine is run too long at light load or idle rpm.

If exhaust pipe is coated with a wet, black, tar-like substance, dry the engine using one of the following run-in procedures.

See the engine manual for additional engine run-in information.

14-2. Run-In Procedure Using Load Bank Or Resistance Grid

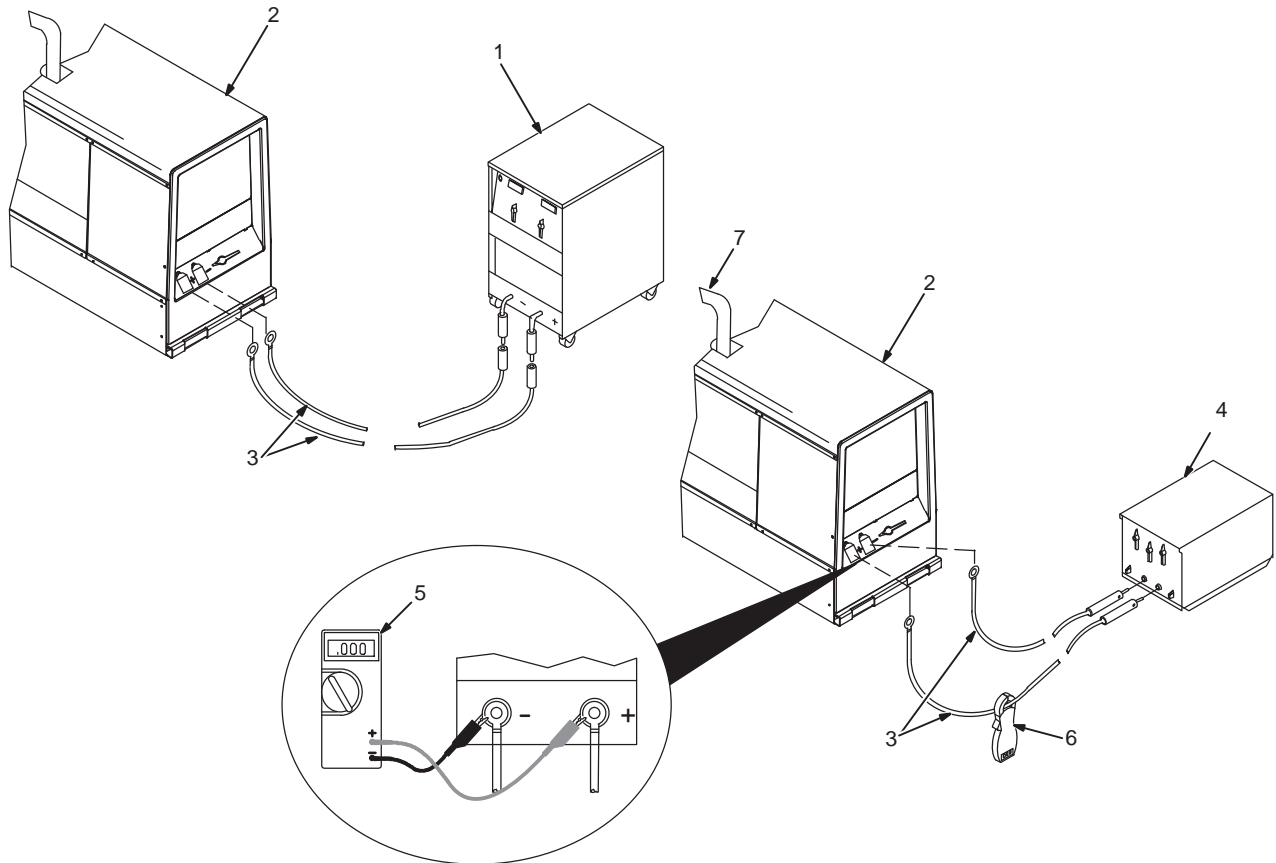

⚠ Stop engine.

⚠ Do not touch hot exhaust pipe, engine parts, or load bank/grid.

⚠ Keep exhaust and pipe away from flammables.

NOTICE – Do not perform run-in procedure at less than 20 volts weld output and do not exceed duty cycle or equipment damage may occur.

1 Load Bank

Turn all load bank switches Off. If needed, connect load bank to 115 volts AC wall receptacle or generator auxiliary power receptacle.

2 Welder/Generator

Place Welder Selector switch in the A position (Single Operator) and rotate A/V control to minimum. Place Process Selector switch in Stick position.

3 Weld Cables

Connect load bank or resistor grid to generator Side A weld output terminals using proper size weld cables with correct connectors. Observe correct polarity.

4 Resistance Grid

Use grid sized for generator rated output.

Turn Off grid.

5 Voltmeter

6 Clamp-On Ammeter

Connect voltmeter and ammeter as shown, if not provided on generator.

Start engine and run for several minutes.

For Load Bank

Set load bank switches and then adjust generator A/V control so load equals rated voltage and current of generator (see nameplate, rating label, or the specifications section in this manual).

For Resistance Grid

Set grid switches and then adjust generator A/V control so load equals rated voltage and current of the generator (see nameplate, rating label, or the specifications section in this manual).

Check generator and meters after first five minutes then every fifteen minutes to be sure generator is loaded properly.

NOTICE – Check oil level frequently during run-in; add oil if needed.

It is recommended to run the welder/generator for two hours minimum and up to four hours under load. Place A/V control in minimum position, then shut down load bank or grid to remove load. Run engine several minutes at no load.

⚠ Stop engine and let cool.

7 Engine Exhaust Pipe

Repeat procedure if wetstacking is present.

SECTION 15 – AIR COMPRESSOR TABLES

15-1. Flow Of Free Air (CFM) Through Orifices Of Various Diameters

Gauge Pressure (psi)	Orifice Diameter (in.) And Free Air Flow (CFM)							
	1/64	1/32	3/64	1/16	3/32	1/8	3/16	1/4
1	0.027	0.107	0.242	0.430	0.97	1.72	3.86	6.85
2	0.038	0.153	0.342	0.607	1.36	2.43	5.42	9.74
3	0.046	0.188	0.471	0.750	1.68	2.98	6.71	11.9
5	0.059	0.242	0.545	0.965	2.18	3.86	8.71	15.4
10	0.084	0.342	0.77	1.36	3.08	5.45	12.3	21.8
15	0.103	0.418	0.94	1.67	3.75	6.65	15.0	26.7
20	0.119	0.485	1.07	1.93	4.25	7.7	17.1	30.8
25	0.133	0.54	1.21	2.16	4.75	8.6	19.4	34.5
30	0.156	0.632	1.40	2.52	5.6	10.0	22.5	40.0
35	0.173	0.71	1.56	2.80	6.2	11.2	25.0	44.7
40	0.19	0.77	1.71	3.07	6.8	12.3	27.3	49.1
45	0.208	0.843	1.9	3.36	7.6	13.4	30.3	53.8
50	0.225	9.14	2.05	3.64	8.2	14.5	32.8	58.2
60	0.26	1.05	2.35	4.2	9.4	16.8	37.5	67.0
70	0.295	1.19	2.68	4.76	10.7	19.0	43.0	76.0
80	0.33	1.33	2.97	5.32	11.9	21.2	47.5	85.0
90	0.364	1.47	3.28	5.87	13.1	23.5	52.5	94.0
100	0.40	1.61	3.66	6.45	14.5	25.8	58.3	103.0
110	0.43	1.76	3.95	7.00	15.7	28.0	63.0	112.0
120	0.47	1.90	4.27	7.58	17.0	30.2	68.0	121.0
130	0.50	2.04	4.57	8.13	18.2	32.4	73.0	130.0
140	0.54	2.17	4.87	8.68	19.5	34.5	78.0	138.0
150	0.57	2.33	5.2	9.20	20.7	36.7	83.0	147.0
175	0.66	2.65	5.94	10.6	23.8	42.1	95.0	169.0
200	0.76	3.07	6.90	12.2	27.5	48.7	110.0	195.0

15-2. Approximate Air Consumption (Cubic Feet) To Operate Pneumatic Equipment At 70–90 PSIG

Miscellaneous Portable Tools	Percent Use Factor And Compressed Air Consumption (CF)			
	9 seconds	15 seconds	21 seconds	1 minute
Drill, 1/18" to 3/8"	3.75	6.25	8.75	25
Drill, 3/8" to 5/16"	5.25	8.75	12.25	35
Screwdriver, #2 to #6 Screw	1.8	3.0	4.2	12
Screwdriver, #6 to 5/16" Screw	3.6	6.0	8.4	24
Tapper, to 3/8"	3.0	5.0	7.0	20
Nutsetters, to 3/8"	3.6	6.0	8.4	24
Nutsetters, to 3/4"	4.5	7.5	10.5	30
Impact Wrench, 1/4"	2.25	3.75	5.3	15
Impact Wrench, 3/8"	3.0	5.0	7.0	20
Impact Wrench, 5/8"	4.5	7.5	10.5	30
Impact Wrench, 3/4"	5.25	8.75	12.25	35
Impact Wrench, 1"	6.75	11.25	15.75	45
Impact Wrench, 1–1/4"	8.25	13.75	19.2	55
Die Grinder, Small	2.25	3.75	5.3	15
Die Grinder, Medium	3.6	6.0	8.4	24
Horizontal Grinder, 2"	3.0	5.0	7.0	20
Horizontal Grinder, 4"	9.0	15.0	21.0	60
Horizontal Grinder, 6"	9.0	15.0	21.0	60
Horizontal Grinder, 8"	12.0	20.0	28.0	80
Vertical Grinders and Sanders, 5" Pad	5.25	8.75	12.25	35
Vertical Grinders and Sanders, 7" Pad	9.0	15.0	21.0	60
Vertical Grinders and Sanders, 9" Pad	10.5	17.5	24.5	70
Burring Tool, Small	2.25	3.75	5.3	15
Burring Tool, Large	3.6	6.0	8.4	24
Rammers, Small	3.9	3.25	9.1	13
Rammers, Medium	5.1	8.5	11.9	34
Rammers, Large	6.0	10.0	14.0	40
Backfill Tamper	3.75	6.25	8.75	25
Compression Riveter	0.2 cubic feet per cycle			
Air Motor, 1 Horsepower	3.75	6.3	8.75	25
Air Motor, 2 Horsepower	7.5	12.5	17.5	50
Air Motor, 3 Horsepower	11.25	18.75	26.3	75
Paint Spray Gun (Production)	3.0	5.0	7.0	20
Scaling Hammer	1.3	3.0	4.2	12
Chipping Hammer	4.5	7.5	10.5	30
Riveting Hammer, Light	2.25	3.75	5.25	15
Riveting Hammer, Heavy	4.5	7.5	10.5	30
Circular Saw, 8"	6.75	11.25	15.75	45
Circular Saw, 12"	9.75	16.25	23.8	65
Chainsaw, Lightweight	4.2	7.0	9.8	28
Chainsaw, Heavy Duty	13.1	21.8	30.5	87

Always check with tool manufacturers for actual air consumption of tools being used. The above is based on averages and should not be considered accurate for any particular make of tool.

Above tools are rated based upon typical "on-load" performance characteristics.

For other values, adjust the cubic feet (CF) air consumption on a proportional basis. The CF air consumption for 1 minute may also be expressed as air consumption in cubic feet per minute (CFM)

SECTION 16 – GENERATOR POWER GUIDELINES

The views in this section are intended to be representative of all engine-driven welder/generators. Your unit may differ from those shown.

16-1. Selecting Equipment

- 1 Generator Power Receptacles – Neutral Bonded To Frame
- 2 3-Prong Plug From Case Grounded Equipment

OR

- 3 2-Prong Plug From Double Insulated Equipment

Be sure equipment has double insulated symbol and/or wording on it.

Do not use 2-prong plug unless equipment is double insulated.

16-2. Grounding Generator to Truck or Trailer Frame

Always ground generator frame to vehicle frame to prevent electric shock and static electricity hazards.

Also see AWS Safety & Health Fact Sheet No. 29, Grounding of Portable And Vehicle Mounted Welding Generators.

Bed liners, shipping skids, and some running gear insulate the welding generator from the vehicle frame. Always connect a ground wire from the generator equipment grounding terminal to bare metal on the vehicle frame as shown.

3 Metal Vehicle Frame

Connect cable from equipment ground terminal to metal vehicle frame. Use #8 AWG or larger insulated copper wire.

Electrically bond generator frame to vehicle frame by metal-to-metal contact.

- 1 Equipment Grounding Terminal (On Front Panel)
- 2 Grounding Cable (Not Supplied)

16-3. Grounding When Supplying Building Systems

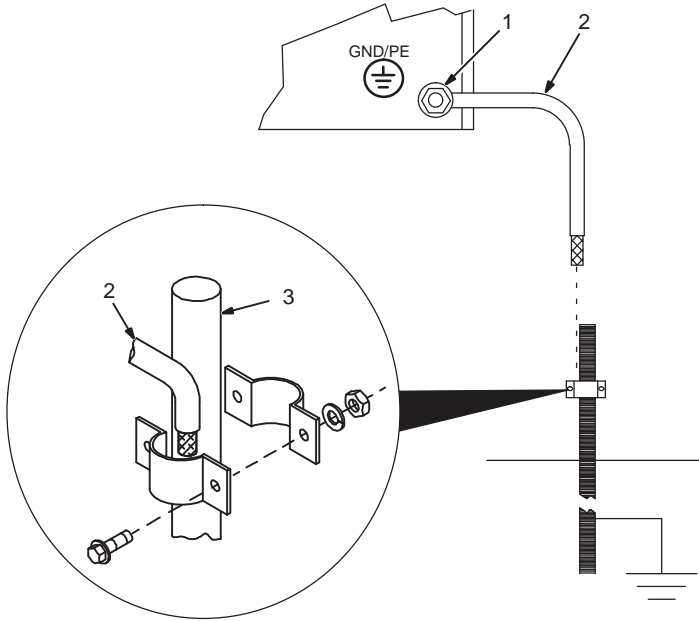

1 Equipment Grounding Terminal

2 Grounding Cable

Use #8 AWG or larger insulated copper wire.

3 Ground Device

Use ground device as stated in electrical codes.

Ground generator to system earth ground if supplying power to a premises (shop, farm) wiring system.

Also see AWS Safety & Health Fact Sheet No. 29, Grounding of Portable And Vehicle Mounted Welding Generators.

16-4. How Much Power Does Equipment Require?

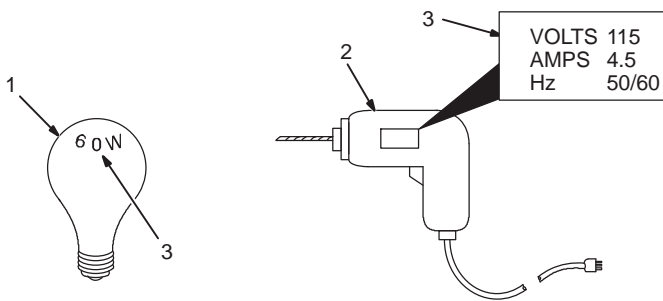

1 Resistive Load

A light bulb is a resistive load and requires a constant amount of power.

2 Non-Resistive Load

Equipment with a motor is a non-resistive load and requires approximately six times more power while starting the motor than when running (see Section 16-8).

3 Rating Data

Rating shows volts and amperes, or watts required to run equipment.

Amperes x Volts = Watts

Example 1: If a drill uses 4.5 amperes at 115 volts, calculate its running power requirement in watts.

$$4.5 \text{ A} \times 115 \text{ V} = 520 \text{ W}$$

The load applied by the drill is 520 watts.

Example 2: If three 200 watt flood lamps are used with the drill from Example 1, add the individual loads to calculate total load.

$$(3 \times 200\text{W}) + 520 \text{ W} = 1120 \text{ W}$$

The total load applied by the three flood lamps and drill is 1120 watts.

16-5. Approximate Power Requirements For Industrial Motors

Industrial Motors	Rating	Starting Watts	Running Watts
Split Phase	1/8 HP	800	300
	1/6 HP	1225	500
	1/4 HP	1600	600
	1/3 HP	2100	700
	1/2 HP	3175	875
Capacitor Start-Induction Run	1/3 HP	2020	720
	1/2 HP	3075	975
	3/4 HP	4500	1400
	1 HP	6100	1600
	1-1/2 HP	8200	2200
	2 HP	10,550	2850
	3 HP	15,900	3900
Capacitor Start-Capacitor Run	1-1/2 HP	8100	2000
	5 HP	23,300	6000
	7-1/2 HP	35,000	8000
	10 HP	46,700	10,700
Fan Duty	1/8 HP	1000	400
	1/6 HP	1400	550
	1/4 HP	1850	650
	1/3 HP	2400	800
	1/2 HP	3500	1100

16-6. Approximate Power Requirements For Farm/Shop Equipment

Farm/Shop Equipment	Rating	Starting Watts	Running Watts
Stock Tank De-Icer		1000	1000
Grain Cleaner	1/4 HP	1650	650
Portable Conveyor	1/2 HP	3400	1000
Grain Elevator	3/4 HP	4400	1400
Milk Cooler		2900	1100
Milker (Vacuum Pump)	2 HP	10,500	2800
Farm Duty Motors Std. (e.g. Conveyors, Feed Augers, Air Compressors)	1/3 HP	1720	720
	1/2 HP	2575	975
	3/4 HP	4500	1400
	1 HP	6100	1600
	1-1/2 HP	8200	2200
	2 HP	10,550	2850
	3 HP	15,900	3900
Farm Duty Motors High Torque (e.g. Barn Cleaners, Silo Unloaders, Silo Hoists, Bunk Feeders)	1-1/2 HP	8100	2000
	5 HP	23,300	6000
	7-1/2 HP	35,000	8000
	10 HP	46,700	10,700
3-1/2 cu. ft. Mixer	1/2 HP	3300	1000
High Pressure 1.8 Gal/Min	500 PSI	3150	950
Washer 2 Gal/Min	550 PSI	4500	1400
	700 PSI	6100	1600
Shallow Well Pump	1/3 HP	2150	750
	1/2 HP	3100	1000

16-7. Approximate Power Requirements For Contractor Equipment

Contractor Equipment	Rating	Starting Watts	Running Watts
Hand Drill	1/4 in.	350	350
	3/8 in.	400	400
	1/2 in.	600	600
Circular Saw	6-1/2 in.	500	500
	7-1/4 in.	900	900
	8-1/4 in.	1400	1400
Table Saw	9 in.	4500	1500
	10 in.	6300	1800
Band Saw	14 in.	2500	1100
Bench Grinder	6 in.	1720	720
	8 in.	3900	1400
	10 in.	5200	1600
Air Compressor	1/2 HP	3000	1000
	1 HP	6000	1500
	1-1/2 HP	8200	2200
	2 HP	10,500	2800
Electric Chain Saw	1-1/2 HP, 12 in.	1100	1100
	2 HP, 14 in.	1100	1100
Electric Trimmer	Standard 9 in.	350	350
	Heavy Duty 12 in.	500	500
Electric Cultivator	1/3 HP	2100	700
Elec. Hedge Trimmer	18 in.	400	400
Flood Lights	HID	125	100
	Metal Halide	313	250
	Mercury	1000	
	Sodium	1400	
	Vapor	1250	1000
Submersible Pump	400 GPH	600	200
Centrifugal Pump	900 GPH	900	500
Floor Polisher	3/4 HP, 16 in.	4500	1400
	1 HP, 20 in.	6100	1600
High Pressure Washer	1/2 HP	3150	950
	3/4 HP	4500	1400
	1 HP	6100	1600
55 gal Drum Mixer	1/4 HP	1900	700
Wet & Dry Vac	1.7 HP	900	900
	2-1/2 HP	1300	1300

16-8. Power Required To Start Motor

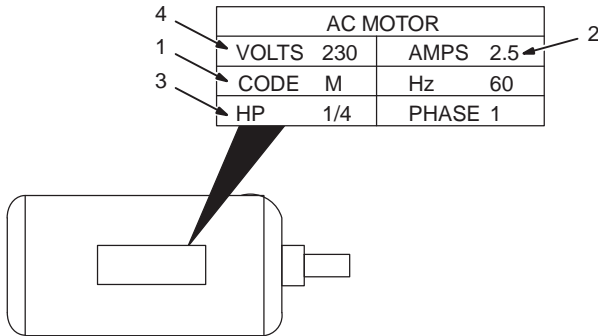

- 1 Motor Start Code
- 2 Running Amperage
- 3 Motor HP
- 4 Motor Voltage

Step 1: Find code and use table to find kVA/HP. If code is not listed, multiply running amperage by six to find starting amperage.

Step 2: Find Motor HP and Volts.

Step 3: Determine starting amperage (see example).

Welder/generator amperage output must be at least twice the motor's running amperage.

(kVA/HP x HP x 1000) / Volts = Starting Amperage

Example: Calculate starting amperage required for a 230 V, 1/4 HP motor with a motor start code of M.

Volts = 230, HP = 1/4, kVA/HP = 11.2

$(11.2 \times 1/4 \times 1000) / 230 = 12.2A$

Starting the motor requires 12.2 amperes.

Single-Phase Induction Motor Starting Requirements

Motor Start Code	G	H	J	K	L	M	N	P
KVA/HP	6.3	7.1	8.0	9.0	10.0	11.2	12.5	14.0

16-9. How Much Power Can Generator Supply?

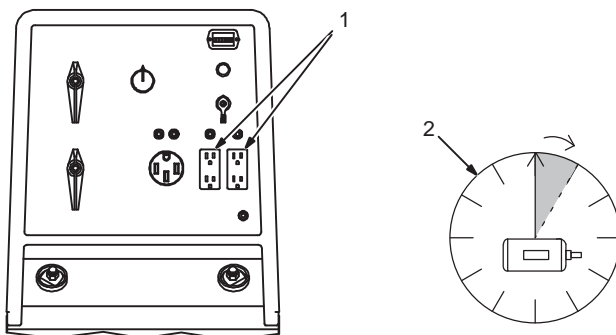
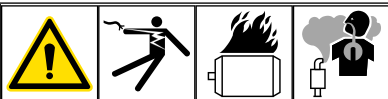

- 1 Limit Load To 90% Of Generator Output

Always start non-resistive (motor) loads in order from largest to smallest, and add resistive loads last.

- 2 5 Second Rule

If motor does not start within 5 seconds, turn off power to prevent motor damage. Motor requires more power than generator can supply.

16-10. Typical Connections To Standby Power

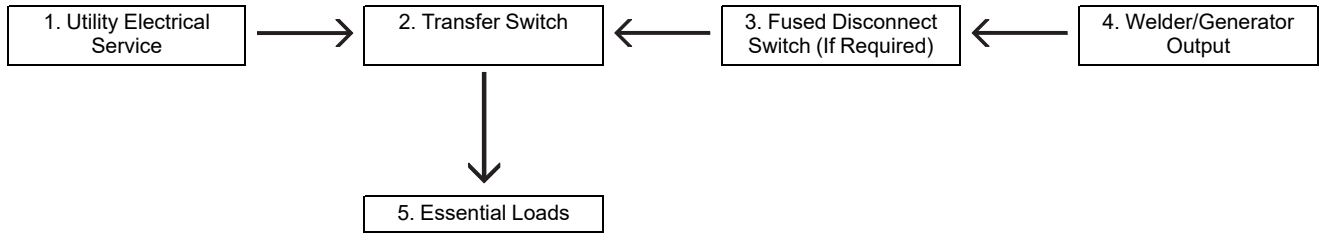

⚠ Have only qualified persons perform these connections according to all applicable codes and safety practices.

⚠ Properly install, ground, and operate this equipment according to its Owner's Manual and national, state, and local codes.

⚠ Do not connect to any electrical distribution system normally supplied by utility power unless a proper transfer switch and grounding procedure are employed.

👉 Customer-supplied equipment is required if generator will supply standby power during emergencies or power outages.

- 1 Utility Electrical Service
- 2 Transfer Switch (Double-Throw)

Switch transfers the electrical load from electric utility service to the generator. Transfer load back to electric utility when service is restored.

Install correct switch (customer-supplied). Switch rating must be same as or greater than the branch overcurrent protection.

- 3 Fused Disconnect Switch

Install correct switch (customer-supplied) if required by electrical code.

- 4 Welder/Generator Output

Generator output voltage and wiring must be consistent with regular (utility) system voltage and wiring.

Connect generator with temporary or permanent wiring suitable for the installation.

Turn off or unplug all equipment connected to generator before starting or stopping engine. When starting or stopping, the engine has low speed which causes low voltage and frequency.

- 5 Essential Loads

Generator output may not meet the electrical requirements of the premises. If generator does not produce enough output to meet all requirements, connect only essential loads. See Section 16-4.

16-11. Selecting Extension Cord (Use Shortest Cord Possible)

A. Cord Lengths For 120 Volt Loads



⚠ Use GFCI protection when operating auxiliary equipment. If unit does not have GFCI receptacles, use GFCI-protected extension cord. Do not use GFCI receptacles to power life support equipment.

		Maximum Allowable Cord Length In ft (m) for Conductor Size In AWG (mm ²)*					
Current (Amperes)	Load (Watts)	4 (25)	6 (16)	8 (10)	10 (6)	12 (4)	14 (2.5)
5	600			350 (106)	225 (68)	137 (42)	100 (30)
7	840		400 (122)	250 (76)	150 (46)	100 (30)	62 (19)
10	1200	400 (122)	275 (84)	175 (53)	112 (34)	62 (19)	50 (15)
15	1800	300 (91)	175 (53)	112 (34)	75 (23)	37 (11)	30 (9)
20	2400	225 (68)	137 (42)	87 (26)	50 (15)	30 (9)	
25	3000	175 (53)	112 (34)	62 (19)	37 (11)		
30	3600	150 (46)	87 (26)	50 (15)	37 (11)		
35	4200	125 (38)	75 (23)	50 (15)			
40	4800	112 (34)	62 (19)	37 (11)			
45	5400	100 (30)	62 (19)				
50	6000	87 (26)	50 (15)				

*Conductor size is based on maximum 2% voltage drop.

B. Cord Lengths For 240 Volt Loads



⚠ Use GFCI protection when operating auxiliary equipment. If unit does not have GFCI receptacles, use GFCI-protected extension cord. Do not use GFCI receptacles to power life support equipment.

		Maximum Allowable Cord Length In ft (m) for Conductor Size In AWG (mm ²)*					
Current (Amperes)	Load (Watts)	4 (25)	6 (16)	8 (10)	10 (6)	12 (4)	14 (2.5)
5	1200			700 (213)	450 (137)	225 (84)	200 (61)
7	1680		800 (244)	500 (152)	300 (91)	200 (61)	125 (38)
10	2400	800 (244)	550 (168)	350 (107)	225 (69)	125 (38)	100 (31)
15	3600	600 (183)	350 (107)	225 (69)	150 (46)	75 (23)	60 (18)
20	4800	450 (137)	275 (84)	175 (53)	100 (31)	60 (18)	
25	6000	350 (107)	225 (69)	125 (38)	75 (23)		
30	7000	300 (91)	175 (53)	100 (31)	75 (23)		
35	8400	250 (76)	150 (46)	100 (31)			
40	9600	225 (69)	125 (38)	75 (23)			
45	10,800	200 (61)	125 (38)				
50	12,000	175 (53)	100 (31)				

*Conductor size is based on maximum 2% voltage drop.

TRUE BLUE[®]

WARRANTY



Effective January 1, 2023 (Equipment with a serial number preface of ND or newer)

This limited warranty supersedes all previous Miller warranties and is exclusive with no other guarantees or warranties expressed or implied.

LIMITED WARRANTY - Subject to the terms and conditions below, Miller Electric Mfg. LLC, Appleton, Wisconsin, warrants to authorized distributors that new Miller equipment sold after the effective date of this limited warranty is free of defects in material and workmanship at the time it is shipped by Miller. THIS WARRANTY IS EXPRESSLY IN LIEU OF ALL OTHER WARRANTIES, EXPRESS OR IMPLIED, INCLUDING THE WARRANTIES OF MERCHANTABILITY AND FITNESS.

Within the warranty periods listed below, Miller will repair or replace any warranted parts or components that fail due to such defects in material or workmanship. Miller must be notified in writing within thirty (30) days of such defect or failure, at which time Miller will provide instructions on the warranty claim procedures to be followed. Notifications submitted as online warranty claims must provide detailed descriptions of the fault and troubleshooting steps taken to diagnose failed parts. Warranty claims that lack the required information as defined in the Miller Service Operation Guide (SOG) may be denied by Miller.

Miller shall honor warranty claims on warranted equipment listed below in the event of a defect within the warranty coverage time periods listed below. Warranty time periods start on the delivery date of the equipment to the end-user purchaser, or 12 months after the equipment is shipped to a US or Canada distributor, or 18 months after the equipment is shipped to an international distributor, whichever occurs first.

1 5 Years Parts — 3 Years Labor

- Original Main Power Rectifiers Only to Include SCRs, Diodes, and Discrete Rectifier Modules in non-inverter products

2 4 Years Parts (No Labor)

- Auto-Darkening ClearLight 2.0 Helmet Lenses

3 3 Years — Parts and Labor Unless Specified

- Auto-Darkening Helmet Lenses (No Labor)
- Engine Driven Welder/Generators (Including EnPak) (**NOTE: Engines are Warranted Separately by the Engine Manufacturer.**)
- Insight Welding Intelligence Products (Except External Sensors)
- Inverter Power Sources
- Plasma Arc Cutting Power Sources
- Process Controllers
- Semi-Automatic and Automatic Wire Feeders
- Transformer/Rectifier Power Sources

4 2 Years — Parts and Labor

- Auto-Darkening Weld Masks (No Labor)
- Fume Extractors - Filtair 215, Capture 5, and Industrial Collector Series

5 1 Year — Parts and Labor Unless Specified

- ArcReach Heater
- AugmentedArc, LiveArc, and MobileArc Welding Systems
- Automatic Motion Devices
- Bernard BTB Air-Cooled MIG Guns (No Labor)

- CoolBelt, PAPER Blower, and PAPER Face Shield (No Labor)
- Desiccant Air Dryer System
- Field Options (**NOTE: Field options are covered for the remaining warranty period of the product they are installed in, or for a minimum of one year — whichever is greater.**)
- RFCS Foot Controls (Except RFCS-RJ45)
- Fume Extractors - Filtair 130, MWX and SWX Series, ZoneFlow Extraction Arms and Motor Control Box
- HF Units
- ICE/XT Plasma Cutting Torches (No Labor)
- Induction Heating Power Sources, Coolers (**NOTE: Digital Recorders are Warranted Separately by the Manufacturer.**)
- Insight Sensors
- Load Banks
- Motor-Driven Guns (except Spoolmate Spoolguns)
- Positioners and Controllers
- Racks (For Housing Multiple Power Sources)
- Running Gear/Trailers
- Subarc Wire Drive Assemblies
- Supplied Air Respirator (SAR) Boxes and Panels
- TIG Torches (No Labor)
- Tregaskiss Guns (No Labor)
- Water Cooling Systems
- Wireless Remote Foot/Hand Controls and Receivers
- Work Stations/Weld Tables (No Labor)

6 6 Months — Parts

- 12 Volt Automotive-Style Batteries

7 90 Days — Parts

- Accessories (Kits)
- ArcReach Heater Quick Wrap and Air Cooled Cables
- Canvas Covers
- Induction Heating Coils and Blankets, Cables, and Non-Electronic Controls
- MDX Series MIG Guns
- M-Guns
- MIG Guns, Subarc (SAW) Torches, and External Cladding Heads
- Remote Controls and RFCS-RJ45
- Replacement Parts (No labor)
- Spoolmate Spoolguns

Miller's True Blue[®] Limited Warranty shall not apply to:

1. **Consumable components; such as contact tips, cutting nozzles, contactors, brushes, relays, work station table tops and welding curtains, or parts that fail due to normal wear. (Exception: brushes and relays are covered on all engine-driven products.)**
2. Items furnished by Miller, but manufactured by others, such as engines or trade accessories. These items are covered by the manufacturer's warranty, if any.
3. Equipment that has been modified by any party other than Miller, or equipment that has been

improperly installed, improperly operated or misused based upon industry standards, or equipment which has not had reasonable and necessary maintenance, or equipment which has been used for operation outside of the specifications for the equipment.

4. Defects caused by accident, unauthorized repair, or improper testing.

MILLER PRODUCTS ARE INTENDED FOR COMMERCIAL AND INDUSTRIAL USERS TRAINED AND EXPERIENCED IN THE USE AND MAINTENANCE OF WELDING EQUIPMENT.

The exclusive remedies for warranty claims are, at Miller's option, either: (1) repair; or (2) replacement; or, if approved in writing by Miller, (3) the pre-approved cost of repair or replacement at an authorized Miller service station; or (4) payment of or credit for the purchase price (less reasonable depreciation based upon use). Products may not be returned without Miller's written approval. Return shipment shall be at customer's risk and expense.

The above remedies are F.O.B. Appleton, WI, or Miller's authorized service facility. Transportation and freight are the customer's responsibility. TO THE EXTENT PERMITTED BY LAW, THE REMEDIES HEREIN ARE THE SOLE AND EXCLUSIVE REMEDIES REGARDLESS OF THE LEGAL THEORY. IN NO EVENT SHALL MILLER BE LIABLE FOR DIRECT, INDIRECT, SPECIAL, INCIDENTAL OR CONSEQUENTIAL DAMAGES (INCLUDING LOSS OF PROFIT) REGARDLESS OF THE LEGAL THEORY. ANY WARRANTY NOT PROVIDED HEREIN AND ANY IMPLIED WARRANTY, GUARANTEE, OR REPRESENTATION, INCLUDING ANY IMPLIED WARRANTY OF MERCHANTABILITY OR FITNESS FOR PARTICULAR PURPOSE, ARE EXCLUDED AND DISCLAIMED BY MILLER.

Some US states do not allow limiting the duration of an implied warranty or the exclusion of certain damages, so the above limitations may not apply to you. This warranty provides specific legal rights, and other rights may be available depending on your state. In Canada, some provinces provide additional warranties or remedies, and to the extent the law prohibits their waiver, the limitations set out above may not apply. This Limited Warranty provides specific legal rights, and other rights may be available, but may vary by province.

Warranty Questions?

Call 1-800-4-A-MILLER for your local Miller distributor.

Your distributor also gives you...

Service

You always get the fast, reliable response you need. Most replacement parts can be in your hands in 24 hours.

Support

Need fast answers to the tough welding questions? The expertise of the distributor and Miller is there to help you, every step of the way.

Owner's Record

Please complete and retain with your personal records.

Model Name _____ Serial/Style Number _____

Purchase Date _____ (Date which equipment was delivered to original customer.) _____

Distributor _____

Address _____

City _____

State _____ Zip _____

For Service

Contact a *DISTRIBUTOR* or *SERVICE AGENCY* near you.

Always provide Model Name and Serial/Style Number.

Contact your Distributor for:

Welding Supplies and Consumables

Options and Accessories

Personal Protective Equipment (PPE)

Service and Repair Replacement Parts

Training (Schools, Videos, Books)

Welding Process Handbooks

To locate a Distributor or Service Agency visit
www.millerwelds.com or call 1-800-4-A-Miller

Contact the Delivering Carrier to:

File a claim for loss or damage during shipment.

For assistance in filing or settling claims, contact your distributor and/or equipment manufacturer's Transportation Department.

Miller Electric Mfg. LLC

An Illinois Tool Works Company
1635 West Spencer Street
Appleton, WI 54914 USA

International Headquarters—USA

USA Phone: 920-735-4505
USA & Canada FAX: 920-735-4134
International FAX: 920-735-4125

For International Locations Visit
www.MillerWelds.com

